

LOAD AND RESISTANCE  
FACTOR DESIGN  
SPECIFICATION



For Structural  
Steel Buildings

December 27, 1999

---

# Load and Resistance Factor Design Specification for Structural Steel Buildings

---

December 27, 1999

Supersedes the *Load and Resistance Factor Design Specification  
for Structural Steel Buildings* dated  
December 1, 1993 and all previous versions.

Prepared by the  
American Institute of Steel Construction, Inc.  
Under the Direction of the  
AISC Committee on Specifications and approved by  
the AISC Board of Directors.



**AMERICAN INSTITUTE OF STEEL CONSTRUCTION, INC.**  
One East Wacker Drive, Suite 3100  
Chicago, Illinois 60601-2001

Copyright © 2000

by

American Institute of Steel Construction, Inc.

*All rights reserved. This book or any part thereof must not be reproduced in any form without the written permission of the publisher.*

**The information presented in this publication has been prepared in accordance with recognized engineering principles and is for general information only. While it is believed to be accurate, this information should not be used or relied upon for any specific application without competent professional examination and verification of its accuracy, suitability, and applicability by a licensed engineer, architect or other professional. The publication of the material contained herein is not intended as a representation or warranty on the part of the American Institute of Steel Construction, Inc. or of any other person named herein, that this information is suitable for any general or particular use or of freedom from infringement of any patent or patents. Anyone making use of this information assumes all liability arising from such use.**

**Caution must be exercised when relying upon other specifications and codes developed by other bodies and incorporated by reference herein since such material may be modified or amended from time to time subsequent to the printing of this edition. The American Institute of Steel Construction, Inc. bears no responsibility for such material other than to refer to it and incorporate it by reference at the time of the initial publication of this edition.**

Printed in the United States of America

## PREFACE

The *AISC Load and Resistance Factor Design (LRFD) Specification for Structural Steel Buildings* is based on reliability theory. As have all AISC Specifications, this Specification has been based upon past successful usage, advances in the state of knowledge, and changes in design practice. This Specification has been developed as a consensus document to provide a uniform practice in the design of steel-framed buildings. The intention is to provide design criteria for routine use and not to provide specific criteria for infrequently encountered problems, which occur in the full range of structural design.

This Specification is the result of the consensus deliberations of a committee of structural engineers with wide experience and high professional standing, representing a wide geographical distribution throughout the U.S. The committee includes approximately equal numbers of engineers in private practice and code agencies, engineers involved in research and teaching, and engineers employed by steel fabricating and producing companies. The contributions and assistance of more than 50 additional professional volunteers working in 15 task committees are also hereby acknowledged.

The Symbols, Glossary, and Appendices to this Specification are an integral part of the Specification. A non-mandatory Commentary has been prepared to provide background for the Specification provisions and the user is encouraged to consult it.

The principal changes incorporated in this edition of the Specification include:

- Dual units format. Values and equations are given in both U.S. customary and metric units. The metric conversions (given in parentheses following the U.S. units) are based on ASTM E380, *Standard Practice for Use of the International System of Units (SI)*. The equations are non-dimensionalized where possible by factoring out material constants, such as  $E$  and  $G$ .
- Inclusion of new structural steels ASTM A913 and A992.
- Additional notch toughness requirements for complete-joint-penetration groove welds with tension applied normal to the effective area.
- New provisions for stability bracing of beams, columns, and frames.
- New Chapter N for evaluation of existing structures.
- Revised provisions for member design under fatigue loading in Appendix K.

- Reorganization of material on pin-connected members and eyebars.
- Revised provisions for concrete-encased beams.
- New limitation on the stud reduction factor when a single stud is used in a rib.
- Revised bolt bearing strength criteria.

The reader is cautioned that professional judgment must be exercised when data or recommendations in the Specification are applied, as described more fully in the disclaimer notice preceding this Preface.

By the Committee,

Stanley D. Lindsey, Chairman	Nestor R. Iwankiw
Roger E. Ferch, Vice Chairman	Lawrence A. Kloiber
Hansraj G. Ashar	Roberto T. Leon
William F. Baker	H.S. Lew
John M. Barsom	James O. Malley
Reidar Bjorhovde	Richard W. Marshall
Roger L. Brockenbrough	Harry W. Martin
Wai-Fah Chen	William A. Milek
Gregory G. Deierlein	Duane K. Miller
Robert O. Disque	Thomas M. Murray
Duane S. Ellifritt	R. Shankar Nair
Bruce R. Ellingwood	Clarkson W. Pinkham
Shu-Jin Fang	Douglas D. Rees-Evans
Steven J. Fenves	Thomas Z. Scarangelo
James M. Fisher	Donald R. Sherman
John W. Fisher	W. Lee Shoemaker
Theodore V. Galambos	Frank F. Sowokinos
Lawrence G. Griffis	William A. Thornton
James R. Harris	Raymond H. R. Tide
Tony C. Hazel	Ivan M. Viest
Mark V. Holland	Joseph A. Yura
	Cynthia J. Lanz, Secretary

# TABLE OF CONTENTS

<b>SYMBOLS</b> . . . . .	xv
<b>GLOSSARY</b> . . . . .	xxiii
<b>SPECIFICATION</b>	
<b>A. GENERAL PROVISIONS</b> . . . . .	1
A1. Scope . . . . .	1
A2. Types of Construction . . . . .	1
A3. Material . . . . .	2
1. Structural Steel . . . . .	2
2. Steel Castings and Forgings . . . . .	4
3. Bolts, Washers, and Nuts . . . . .	4
4. Anchor Rods and Threaded Rods . . . . .	5
5. Filler Metal and Flux for Welding . . . . .	5
6. Stud Shear Connectors . . . . .	6
A4. Loads and Load Combinations . . . . .	6
A5. Design Basis . . . . .	6
1. Required Strength at Factored Loads . . . . .	6
2. Limit States . . . . .	7
3. Design for Strength . . . . .	7
4. Design for Serviceability and Other Considerations . . . . .	7
A6. Referenced Codes and Standards . . . . .	7
A7. Design Documents . . . . .	8
<b>B. DESIGN REQUIREMENTS</b> . . . . .	10
B1. Gross Area . . . . .	10
B2. Net Area . . . . .	10
B3. Effective Area of Tension Members . . . . .	10
B4. Stability . . . . .	11
B5. Local Buckling . . . . .	12
1. Classification of Steel Sections . . . . .	12
2. Design by Plastic Analysis . . . . .	13
3. Slender-Element Compression Sections . . . . .	13
B6. Bracing at Supports . . . . .	13
B7. Limiting Slenderness Ratios . . . . .	13
B8. Simple Spans . . . . .	13
B9. End Restraint . . . . .	13
B10. Proportions of Beams and Girders . . . . .	13
<b>C. FRAMES AND OTHER STRUCTURES</b> . . . . .	17
C1. Second Order Effects . . . . .	17
1. Design by Plastic Analysis . . . . .	17
2. Design by Elastic Analysis . . . . .	17
C2. Frame Stability . . . . .	18
1. Braced Frames . . . . .	18
2. Unbraced Frames . . . . .	19

**SPECIFICATION (Cont'd)**

C3.	Stability Bracing . . . . .	19
1.	Scope . . . . .	19
2.	Frames. . . . .	19
3.	Columns. . . . .	20
4.	Beams . . . . .	21
<b>D.</b>	<b>TENSION MEMBERS . . . . .</b>	<b>24</b>
D1.	Design Tensile Strength . . . . .	24
D2.	Built-Up Members . . . . .	24
D3.	Pin-Connected Members and Eyebars . . . . .	25
1.	Pin-Connected Members . . . . .	25
2.	Eyebars . . . . .	26
<b>E.</b>	<b>COLUMNS AND OTHER COMPRESSION MEMBERS. . . . .</b>	<b>27</b>
E1.	Effective Length and Slenderness Limitations. . . . .	27
1.	Effective Length. . . . .	27
2.	Design by Plastic Analysis . . . . .	27
E2.	Design Compressive Strength for Flexural Buckling . . . . .	27
E3.	Design Compressive Strength for Flexural-Torsional Buckling . . . . .	28
E4.	Built-Up Members . . . . .	28
1.	Design Strength . . . . .	28
2.	Detailing Requirements . . . . .	29
E5.	Connections for Pin-Connected Compression Members . . . . .	30
<b>F.</b>	<b>BEAMS AND OTHER FLEXURAL MEMBERS . . . . .</b>	<b>31</b>
F1.	Design for Flexure . . . . .	31
1.	Yielding . . . . .	31
2.	Lateral-Torsional Buckling . . . . .	32
3.	Design by Plastic Analysis . . . . .	34
F2.	Design for Shear . . . . .	35
1.	Web Area Determination . . . . .	35
2.	Design Shear Strength. . . . .	35
3.	Transverse Stiffeners . . . . .	36
F3.	Web-Tapered Members . . . . .	36
F4.	Beams and Girders with Web Openings . . . . .	36
<b>G.</b>	<b>PLATE GIRDERS . . . . .</b>	<b>37</b>
<b>H.</b>	<b>MEMBERS UNDER COMBINED FORCES AND TORSION . . . . .</b>	<b>38</b>
H1.	Symmetric Members Subject to Bending and Axial Force . . . . .	38
1.	Doubly and Singly Symmetric Members in Flexure and Tension . . . . .	38
2.	Doubly and Singly Symmetric Members in Flexure and Compression. . . . .	39
H2.	Unsymmetric Members and Members Under Torsion and Combined Torsion, Flexure, Shear, and/or Axial Force . . . . .	39
H3.	Alternative Interaction Equations for Members Under Combined Stress (see Appendix H3) . . . . .	39
<b>I.</b>	<b>COMPOSITE MEMBERS . . . . .</b>	<b>40</b>
I1.	Design Assumptions and Definitions . . . . .	40
I2.	Compression Members. . . . .	41
1.	Limitations . . . . .	41

**SPECIFICATION (Cont'd)**

2.	Design Strength . . . . .	42
3.	Columns with Multiple Steel Shapes . . . . .	42
4.	Load Transfer . . . . .	43
I3.	Flexural Members . . . . .	43
1.	Effective Width . . . . .	43
2.	Design Strength of Beams with Shear Connectors . . . . .	43
3.	Design Strength of Concrete-Encased Beams . . . . .	44
4.	Strength During Construction . . . . .	44
5.	Formed Steel Deck . . . . .	44
6.	Design Shear Strength. . . . .	46
I4.	Combined Compression and Flexure . . . . .	46
I5.	Shear Connectors. . . . .	46
1.	Materials. . . . .	46
2.	Horizontal Shear Force . . . . .	46
3.	Strength of Stud Shear Connectors . . . . .	47
4.	Strength of Channel Shear Connectors . . . . .	47
5.	Required Number of Shear Connectors . . . . .	47
6.	Shear Connector Placement and Spacing . . . . .	48
I6.	Special Cases. . . . .	48
<b>J.</b>	<b>CONNECTIONS, JOINTS, AND FASTENERS . . . . .</b>	<b>49</b>
J1.	General Provisions . . . . .	49
1.	Design Basis. . . . .	49
2.	Simple Connections . . . . .	49
3.	Moment Connections . . . . .	49
4.	Compression Members with Bearing Joints . . . . .	49
5.	Splices in Heavy Sections . . . . .	49
6.	Beam Copes and Weld Access Holes. . . . .	50
7.	Minimum Strength of Connections . . . . .	50
8.	Placement of Welds and Bolts . . . . .	51
9.	Bolts in Combination with Welds . . . . .	51
10.	High-Strength Bolts in Combination with Rivets . . . . .	51
11.	Limitations on Bolted and Welded Connections . . . . .	51
J2.	Welds. . . . .	52
1.	Groove Welds. . . . .	52
2.	Fillet Welds . . . . .	53
3.	Plug and Slot Welds . . . . .	56
4.	Design Strength . . . . .	56
5.	Combination of Welds. . . . .	58
6.	Weld Metal Requirements . . . . .	58
7.	Mixed Weld Metal. . . . .	58
8.	Preheat for Heavy Shapes . . . . .	58
J3.	Bolts and Threaded Parts. . . . .	58
1.	High-Strength Bolts . . . . .	58
2.	Size and Use of Holes . . . . .	59
3.	Minimum Spacing . . . . .	60
4.	Minimum Edge Distance . . . . .	60
5.	Maximum Spacing and Edge Distance . . . . .	60
6.	Design Tension or Shear Strength . . . . .	62



**SPECIFICATION (Cont'd)**

7.	Combined Tension and Shear in Bearing-Type Connections . . . . .	63
8.	High-Strength Bolts in Slip-Critical Connections . . . . .	64
9.	Combined Tension and Shear in Slip-Critical Connections . . . . .	66
10.	Bearing Strength at Bolt Holes . . . . .	66
11.	Long Grips . . . . .	67
J4.	Design Rupture Strength . . . . .	67
1.	Shear Rupture Strength . . . . .	67
2.	Tension Rupture Strength. . . . .	67
3.	Block Shear Rupture Strength. . . . .	67
J5.	Connecting Elements. . . . .	68
1.	Eccentric Connections. . . . .	68
2.	Design Strength of Connecting Elements in Tension . . . . .	68
3.	Other Connecting Elements . . . . .	68
J6.	Fillers . . . . .	69
J7.	Splices . . . . .	69
J8.	Bearing Strength . . . . .	69
J9.	Column Bases and Bearing on Concrete. . . . .	70
J10.	Anchor Rods and Embedments . . . . .	70
<b>K.</b>	<b>CONCENTRATED FORCES, PONDING, AND FATIGUE.</b> . . . .	<b>71</b>
K1.	Flanges and Webs with Concentrated Forces . . . . .	71
1.	Design Basis. . . . .	71
2.	Flange Local Bending . . . . .	71
3.	Web Local Yielding . . . . .	72
4.	Web Crippling. . . . .	72
5.	Web Sidesway Buckling. . . . .	73
6.	Web Compression Buckling . . . . .	74
7.	Web Panel-Zone Shear . . . . .	75
8.	Unframed Ends of Beams and Girders . . . . .	76
9.	Additional Stiffener Requirements for Concentrated Forces . . . . .	76
10.	Additional Doubler Plate Requirements for Concentrated Forces . . . . .	76
K2.	Ponding . . . . .	77
K3.	Design for Cyclic Loading (Fatigue). . . . .	77
<b>L.</b>	<b>SERVICEABILITY DESIGN CONSIDERATIONS</b> . . . . .	<b>79</b>
L1.	Camber . . . . .	79
L2.	Expansion and Contraction . . . . .	79
L3.	Deflections, Vibration, and Drift . . . . .	79
1.	Deflections . . . . .	79
2.	Floor Vibration . . . . .	79
3.	Drift . . . . .	79
L4.	Connection Slip . . . . .	80
L5.	Corrosion. . . . .	80
<b>M.</b>	<b>FABRICATION, ERECTION, AND QUALITY CONTROL</b> . . . . .	<b>81</b>
M1.	Shop Drawings . . . . .	81
M2.	Fabrication . . . . .	81
1.	Cambering, Curving, and Straightening . . . . .	81
2.	Thermal Cutting . . . . .	81
3.	Planing of Edges . . . . .	81

**SPECIFICATION (Cont'd)**

4.	Welded Construction . . . . .	82
5.	Bolted Construction . . . . .	82
6.	Compression Joints . . . . .	82
7.	Dimensional Tolerances . . . . .	82
8.	Finish of Column Bases . . . . .	82
M3.	Shop Painting . . . . .	83
1.	General Requirements . . . . .	83
2.	Inaccessible Surfaces . . . . .	83
3.	Contact Surfaces . . . . .	83
4.	Finished Surfaces . . . . .	83
5.	Surfaces Adjacent to Field Welds . . . . .	83
M4.	Erection . . . . .	83
1.	Alignment of Column Bases . . . . .	83
2.	Bracing . . . . .	83
3.	Alignment . . . . .	84
4.	Fit of Column Compression Joints and Base Plates . . . . .	84
5.	Field Welding . . . . .	84
6.	Field Painting . . . . .	84
7.	Field Connections . . . . .	84
M5.	Quality Control . . . . .	84
1.	Cooperation . . . . .	84
2.	Rejections . . . . .	84
3.	Inspection of Welding . . . . .	85
4.	Inspection of Slip-Critical High-Strength Bolted Connections . . . . .	85
5.	Identification of Steel . . . . .	85
<b>N.</b>	<b>EVALUATION OF EXISTING STRUCTURES . . . . .</b>	<b>86</b>
N1.	General Provisions . . . . .	86
N2.	Material Properties . . . . .	86
1.	Determination of Required Tests . . . . .	86
2.	Tensile Properties . . . . .	86
3.	Chemical Composition . . . . .	86
4.	Base Metal Notch Toughness . . . . .	87
5.	Weld Metal . . . . .	87
6.	Bolts and Rivets . . . . .	87
N3.	Evaluation by Structural Analysis . . . . .	87
1.	Dimensional Data . . . . .	87
2.	Strength Evaluation . . . . .	87
3.	Serviceability Evaluation . . . . .	87
N4.	Evaluation by Load Tests . . . . .	88
1.	Determination of Live Load Rating by Testing . . . . .	88
2.	Serviceability Evaluation . . . . .	88
N5.	Evaluation Report . . . . .	88
<b>APPENDIX B. DESIGN REQUIREMENTS . . . . .</b>	<b>89</b>	
B5.	Local Buckling . . . . .	89
1.	Classification of Steel Sections . . . . .	89
3.	Slender-Element Compression Sections . . . . .	89
<b>APPENDIX E. COLUMNS AND OTHER COMPRESSION MEMBERS . . . . .</b>	<b>94</b>	

**SPECIFICATION (Cont'd)**  
 E3. Design Compressive Strength for Flexural-Torsional Buckling . . . . . 94

**APPENDIX F. BEAMS AND OTHER FLEXURAL MEMBERS** . . . . . 96

F1. Design for Flexure . . . . . 96

F2. Design for Shear . . . . . 102

    2. Design Shear Strength . . . . . 102

    3. Transverse Stiffeners . . . . . 102

F3. Web-Tapered Members . . . . . 103

    1. General Requirements . . . . . 103

    2. Design Tensile Strength . . . . . 103

    3. Design Compressive Strength . . . . . 103

    4. Design Flexural Strength . . . . . 104

    5. Design Shear Strength . . . . . 106

    6. Combined Flexure and Axial Force . . . . . 106

**APPENDIX G. PLATE GIRDERS** . . . . . 107

G1. Limitations . . . . . 107

G2. Design Flexural Strength . . . . . 107

G3. Design Shear Strength . . . . . 109

G4. Transverse Stiffeners . . . . . 110

G5. Flexure-Shear Interaction . . . . . 111

**APPENDIX H. MEMBERS UNDER COMBINED FORCES AND TORSION** . . . . . 112

H3. Alternative Interaction Equations for Members Under Combined Stress . . . . . 112

**APPENDIX J. CONNECTIONS, JOINTS, AND FASTENERS** . . . . . 115

J2. Welds . . . . . 115

    4. Design Strength . . . . . 115

J3. Bolts and Threaded Parts . . . . . 117

    7. Combined Tension and Shear in Bearing-Type Connections . . . . . 117

    8. High-Strength Bolts in Slip-Critical Connections . . . . . 117

    9. Combined Tension and Shear in Slip-Critical Connections . . . . . 117

**APPENDIX K. CONCENTRATED FORCES, PONDING, AND FATIGUE** . 118

K2. Ponding . . . . . 118

K3. Design for Cyclic Loading (Fatigue) . . . . . 121

    1. General . . . . . 121

    2. Calculation of Maximum Stresses and Stress Ranges . . . . . 121

    3. Design Stress Range . . . . . 122

    4. Bolts and Threaded Parts . . . . . 124

    5. Special Fabrication and Erection Requirements . . . . . 124

**NUMERICAL VALUES** . . . . . 140

**COMMENTARY**

**INTRODUCTION** . . . . . 163

**A. GENERAL PROVISIONS** . . . . . 164

A1. Scope . . . . . 164

A2. Types of Construction . . . . . 164

**COMMENTARY (Cont'd)**

A3.	Material . . . . .	167
1.	Structural Steel . . . . .	167
3.	Bolts, Washers, and Nuts . . . . .	169
4.	Anchor Rods and Threaded Rods . . . . .	170
5.	Filler Metal and Flux for Welding . . . . .	170
A4.	Loads and Load Combinations . . . . .	171
A5.	Design Basis . . . . .	172
1.	Required Strength at Factored Loads . . . . .	172
2.	Limit States . . . . .	172
3.	Design for Strength . . . . .	172
4.	Design for Serviceability and Other Considerations . . . . .	176
<b>B.</b>	<b>DESIGN REQUIREMENTS . . . . .</b>	<b>177</b>
B2.	Net Area . . . . .	177
B3.	Effective Area of Tension Members . . . . .	177
B5.	Local Buckling . . . . .	179
B7.	Limiting Slenderness Ratios . . . . .	182
<b>C.</b>	<b>FRAMES AND OTHER STRUCTURES . . . . .</b>	<b>184</b>
C1.	Second Order Effects . . . . .	184
C2.	Frame Stability . . . . .	188
C3.	Stability Bracing . . . . .	195
1.	Scope . . . . .	195
3.	Columns . . . . .	198
4.	Beams . . . . .	199
<b>D.</b>	<b>TENSION MEMBERS . . . . .</b>	<b>202</b>
D1.	Design Tensile Strength. . . . .	202
D2.	Built-Up Members . . . . .	202
D3.	Pin-Connected Members and Eyebars . . . . .	202
<b>E.</b>	<b>COLUMNS AND OTHER COMPRESSION MEMBERS. . . . .</b>	<b>203</b>
E1.	Effective Length and Slenderness Limitations. . . . .	203
1.	Effective Length . . . . .	203
2.	Design by Plastic Analysis . . . . .	203
E2.	Design Compressive Strength for Flexural Buckling. . . . .	203
E3.	Design Compressive Strength for Flexural-Torsional Buckling . . . . .	204
E4.	Built-Up Members . . . . .	205
<b>F.</b>	<b>BEAMS AND OTHER FLEXURAL MEMBERS. . . . .</b>	<b>206</b>
F1.	Design for Flexure . . . . .	206
1.	Yielding . . . . .	206
2.	Lateral-Torsional Buckling . . . . .	206
3.	Design by Plastic Analysis. . . . .	209
F2.	Design for Shear . . . . .	210
F4.	Beams and Girders with Web Openings . . . . .	210
<b>H.</b>	<b>MEMBERS UNDER COMBINED FORCES AND TORSION . . . . .</b>	<b>212</b>
H1.	Symmetric Members Subject to Bending and Axial Force. . . . .	212
H2.	Unsymmetric Members and Members Under Torsion and Combined Torsion, Flexure, Shear, and/or Axial Force . . . . .	213

**COMMENTARY (Cont'd)**

<b>I. COMPOSITE MEMBERS</b> . . . . .	214
I1. Design Assumptions and Definitions . . . . .	214
I2. Compression Members . . . . .	215
1. Limitations . . . . .	215
2. Design Strength . . . . .	216
3. Columns with Multiple Steel Shapes . . . . .	216
4. Load Transfer . . . . .	216
I3. Flexural Members . . . . .	217
1. Effective Width . . . . .	217
2. Design Strength of Beams with Shear Connectors . . . . .	217
3. Design Strength of Concrete-Encased Beams . . . . .	221
4. Strength During Construction . . . . .	222
5. Formed Steel Deck . . . . .	222
6. Design Shear Strength . . . . .	225
I4. Combined Compression and Flexure . . . . .	225
I5. Shear Connectors . . . . .	226
1. Materials . . . . .	226
2. Horizontal Shear Force . . . . .	226
3. Strength of Stud Shear Connectors . . . . .	227
4. Strength of Channel Shear Connectors . . . . .	227
6. Shear Connector Placement and Spacing . . . . .	227
I6. Special Cases . . . . .	228
<b>J. CONNECTIONS, JOINTS, AND FASTENERS</b> . . . . .	229
J1. General Provisions . . . . .	229
5. Splices in Heavy Sections . . . . .	229
8. Placement of Welds and Bolts . . . . .	231
9. Bolts in Combination with Welds . . . . .	231
10. High-Strength Bolts in Combination with Rivets . . . . .	232
J2. Welds . . . . .	232
1. Groove Welds . . . . .	232
2. Fillet Welds . . . . .	232
4. Design Strength . . . . .	238
5. Combination of Welds . . . . .	239
6. Weld Metal Requirements . . . . .	239
7. Mixed Weld Metal . . . . .	240
J3. Bolts and Threaded Parts . . . . .	240
1. High-Strength Bolts . . . . .	240
2. Size and Use of Holes . . . . .	241
3. Minimum Spacing . . . . .	241
4. Minimum Edge Distance . . . . .	241
5. Maximum Spacing and Edge Distance . . . . .	242
6. Design Tension or Shear Strength . . . . .	242
7. Combined Tension and Shear in Bearing-Type Connections . . . . .	243
8. High-Strength Bolts in Slip-Critical Connections . . . . .	243
10. Bearing Strength at Bolt Holes . . . . .	246
11. Long Grips . . . . .	246
J4. Design Rupture Strength . . . . .	246
J5. Connecting Elements . . . . .	248

<b>COMMENTARY (Cont'd)</b>	
2.	Design Strength of Connecting Elements in Tension . . . . . 248
J6.	Fillers . . . . . 248
J8.	Bearing Strength . . . . . 248
J9.	Column Bases and Bearing on Concrete . . . . . 248
<b>K.</b>	<b>CONCENTRATED FORCES, PONDING, AND FATIGUE . . . . . 249</b>
K1.	Flanges and Webs with Concentrated Forces . . . . . 249
1.	Design Basis . . . . . 249
2.	Flange Local Bending . . . . . 249
3.	Web Local Yielding . . . . . 249
4.	Web Crippling . . . . . 250
5.	Web Sidesway Buckling . . . . . 250
6.	Web Compression Buckling . . . . . 251
7.	Web Panel-Zone Shear . . . . . 252
K2.	Ponding . . . . . 254
<b>L.</b>	<b>SERVICEABILITY DESIGN CONSIDERATIONS . . . . . 257</b>
L1.	Camber . . . . . 258
L2.	Expansion and Contraction . . . . . 258
L3.	Deflections, Vibration, and Drift . . . . . 258
1.	Deflections . . . . . 258
2.	Floor Vibration . . . . . 258
3.	Drift . . . . . 259
L5.	Corrosion . . . . . 259
<b>M.</b>	<b>FABRICATION, ERECTION, AND QUALITY CONTROL . . . . . 260</b>
M2.	Fabrication . . . . . 260
1.	Cambering, Curving, and Straightening . . . . . 260
2.	Thermal Cutting . . . . . 260
5.	Bolted Construction . . . . . 260
M3.	Shop Painting . . . . . 261
5.	Surfaces Adjacent to Field Welds . . . . . 261
M4.	Erection . . . . . 261
2.	Bracing . . . . . 261
4.	Fit of Column Compression Joints and Base Plates . . . . . 261
5.	Field Welding . . . . . 261
<b>N.</b>	<b>EVALUATION OF EXISTING STRUCTURES . . . . . 262</b>
N1.	General Provisions . . . . . 262
N2.	Material Properties . . . . . 262
1.	Determination of Required Tests . . . . . 262
2.	Tensile Properties . . . . . 262
4.	Base Metal Notch Toughness . . . . . 263
5.	Weld Metal . . . . . 263
6.	Bolts and Rivets . . . . . 263
N3.	Evaluation by Structural Analysis . . . . . 263
2.	Strength Evaluation . . . . . 263
N4.	Evaluation by Load Tests . . . . . 263
1.	Determination of Live Load Rating by Testing . . . . . 263
2.	Serviceability Evaluation . . . . . 264
N5.	Evaluation Report . . . . . 265

**COMMENTARY (Cont'd)**

**APPENDIX B. DESIGN REQUIREMENTS** . . . . . 266

    B5. Local Buckling . . . . . 266

        1. Classification of Steel Sections . . . . . 266

**APPENDIX E. COLUMNS AND OTHER COMPRESSION MEMBERS.** . . . . 267

    E3. Design Compressive Strength for Flexural-Torsional Buckling . . . . . 267

**APPENDIX F. BEAMS AND OTHER FLEXURAL MEMBERS** . . . . . 268

    F1. Design for Flexure . . . . . 268

    F3. Web-Tapered Members . . . . . 268

        1. General Requirements . . . . . 268

        3. Design Compressive Strength . . . . . 269

        4. Design Flexural Strength . . . . . 270

**APPENDIX G. PLATE GIRDERS** . . . . . 271

    G2. Design Flexural Strength . . . . . 271

**APPENDIX H. MEMBERS UNDER COMBINED FORCES AND TORSION** . . . . . 272

    H3. Alternative Interaction Equations for Members Under Combined Stress . . . . . 272

**APPENDIX J. CONNECTIONS, JOINTS, AND FASTENERS** . . . . . 273

    J2. Welds . . . . . 273

        4. Design Strength . . . . . 273

**APPENDIX K. CONCENTRATED FORCES, PONDING, AND FATIGUE** . 276

    K3. Design for Cyclic Loading (Fatigue) . . . . . 276

**REFERENCES** . . . . . 279

**SUPPLEMENTARY BIBLIOGRAPHY** . . . . . 290

## SYMBOLS

The section number in the right hand column refers to the section where the symbol is first used.

<u>Symbol</u>	<u>Definition</u>	<u>Section</u>
$A$	Area of directly connected elements . . . . .	B3
$A_B$	Loaded area of concrete, in. <sup>2</sup> (mm <sup>2</sup> ). . . . .	I2.4
$A_b$	Nominal unthreaded body area of bolt or threaded part, in. <sup>2</sup> (mm <sup>2</sup> ) . . . . .	J3.6
$A_c$	Area of concrete, in. <sup>2</sup> (mm <sup>2</sup> ) . . . . .	I2.2
$A_c$	Area of concrete slab within effective width, in. <sup>2</sup> (mm <sup>2</sup> ) . . . . .	I5.2
$A_D$	Area of an upset rod based on the major thread diameter, in. <sup>2</sup> (mm <sup>2</sup> ) . . . . .	J3.6
$A_e$	Effective area, in. <sup>2</sup> (mm <sup>2</sup> ) . . . . .	B3
$A_f$	Area of the compression flange, in. <sup>2</sup> (mm <sup>2</sup> ). . . . .	App. F3
$A_{fe}$	Effective tension flange area, in. <sup>2</sup> (mm <sup>2</sup> ) . . . . .	B10
$A_{fg}$	Gross area of flange, in. <sup>2</sup> (mm <sup>2</sup> ). . . . .	B10
$A_{fn}$	Net area of flange, in. <sup>2</sup> (mm <sup>2</sup> ). . . . .	B10
$A_g$	Gross area, in. <sup>2</sup> (mm <sup>2</sup> ). . . . .	A5
$A_{gt}$	Gross area subject to tension, in. <sup>2</sup> (mm <sup>2</sup> ) . . . . .	J4.3
$A_{gv}$	Gross area subject to shear, in. <sup>2</sup> (mm <sup>2</sup> ) . . . . .	J4.3
$A_n$	Net area, in. <sup>2</sup> (mm <sup>2</sup> ) . . . . .	B2
$A_{nt}$	Net area subject to tension, in. <sup>2</sup> (mm <sup>2</sup> ) . . . . .	J4.2
$A_{nv}$	Net area subject to shear, in. <sup>2</sup> (mm <sup>2</sup> ) . . . . .	J4.1
$A_{pb}$	Projected bearing area, in. <sup>2</sup> (mm <sup>2</sup> ). . . . .	J8.1
$A_r$	Area of reinforcing bars, in. <sup>2</sup> (mm <sup>2</sup> ). . . . .	I2.2
$A_s$	Area of steel cross section, in. <sup>2</sup> (mm <sup>2</sup> ) . . . . .	I2.2
$A_{sc}$	Cross-sectional area of stud shear connector, in. <sup>2</sup> (mm <sup>2</sup> ) . . . . .	I5.3
$A_{sf}$	Shear area on the failure path, in. <sup>2</sup> (mm <sup>2</sup> ). . . . .	D3
$A_t$	Net tensile area, in. <sup>2</sup> (mm <sup>2</sup> ) . . . . .	App. K3
$A_w$	Web area, in. <sup>2</sup> (mm <sup>2</sup> ) . . . . .	F2.1
$A_1$	Area of steel concentrically bearing on a concrete support, in. <sup>2</sup> (mm <sup>2</sup> ) . . . . .	J9
$A_2$	Total cross-sectional area of a concrete support, in. <sup>2</sup> (mm <sup>2</sup> ) . . . . .	J9
$B$	Factor for bending stress in tees and double angles . . . . .	F1.2
$B$	Factor for bending stress in web-tapered members, in. (mm), defined by Equations A-F3-8 through A-F3-11. . . . .	App. F3
$B_1, B_2$	Factors used in determining $M_u$ for combined bending and axial forces when first-order analysis is employed . . . . .	C1
$C_{PG}$	Plate-girder coefficient . . . . .	App. G2
$C_b$	Bending coefficient dependent on moment gradient . . . . .	F1.2a
$C_f$	Constant based on stress category, given in Table A-K3.1 . . . . .	App. K3.3
$C_m$	Coefficient applied to bending term in interaction formula for prismatic members and dependent on column curvature caused by applied moments . . . . .	C1
$C_m'$	Coefficient applied to bending term in interaction formula for tapered members and dependent on axial stress at the	



	small end of the member . . . . .	App. F3
$C_p$	Ponding flexibility coefficient for primary member in a flat roof . . . . .	K2
$C_s$	Ponding flexibility coefficient for secondary member in a flat roof . . . . .	K2
$C_v$	Ratio of “critical” web stress, according to linear buckling theory, to the shear yield stress of web material . . . . .	App. G3
$C_w$	Warping constant, in. <sup>6</sup> (mm <sup>6</sup> ) . . . . .	F1.2
$D$	Outside diameter of circular hollow section, in. (mm) . . . . .	App. B5.3
$D$	Dead load due to the weight of the structural elements and permanent features on the structure; nominal dead load . . . . .	App. K2
$D$	Factor used in Equation A-G4-2, dependent on the type of transverse stiffeners used in a plate girder . . . . .	App. G4
$E$	Modulus of elasticity of steel, $E = 29,000$ ksi (200 000 MPa) . . . . .	E2
$E$	Earthquake load	
$E_c$	Modulus of elasticity of concrete, ksi (MPa) . . . . .	I2.2
$E_m$	Modified modulus of elasticity, ksi (MPa) . . . . .	I2.2
$F_{BM}$	Nominal strength of the base material to be welded, ksi (MPa) . . . . .	J2.4
$F_{EXX}$	Classification number of weld metal (minimum specified strength), ksi (MPa) . . . . .	J2.4
$F_L$	Smaller of $(F_y - F_r)$ or $F_{yw}$ , ksi (MPa) . . . . .	F1.2
$F_{SR}$	Design stress range, ksi (MPa) . . . . .	App. K3.3
$F_{TH}$	Threshold fatigue stress range, maximum stress range for indefinite design life, ksi (MPa) . . . . .	App. K3.3
$F_{bt}$	Flexural stress for tapered members defined by Equations A-F3-4 and A-F3-5 . . . . .	App. F3
$F_{cr}$	Critical stress, ksi (MPa) . . . . .	E2
$F_{crft}$ , $F_{cry}$ , $F_{crz}$	Flexural-torsional buckling stresses for double-angle and tee-shaped compression members, ksi (MPa) . . . . .	E3
$F_e$	Elastic buckling stress, ksi (MPa) . . . . .	App. E3
$F_{ex}$	Elastic flexural buckling stress about the major axis, ksi (MPa) . . . . .	App. E3
$F_{ey}$	Elastic flexural buckling stress about the minor axis, ksi (MPa) . . . . .	App. E3
$F_{ez}$	Elastic torsional buckling stress, ksi (MPa) . . . . .	App. E3
$F_{my}$	Modified yield stress for composite columns, ksi (MPa) . . . . .	I2.2
$F_n$	Nominal shear rupture strength, ksi (MPa) . . . . .	J4
$F_r$	Compressive residual stress in flange [10 ksi (69 MPa) for rolled shapes; 16.5 ksi (114 MPa) for welded built-up shapes]. . . . .	B5.1
$F_{sT}$	Stress for tapered members defined by Equation A-F3-6, ksi (MPa) . . . . .	App. F3
$F_u$	Specified minimum tensile strength of the type of steel being used, ksi (MPa) . . . . .	B10
$F_w$	Nominal strength of the weld electrode material, ksi (MPa) . . . . .	J2.4
$F_{wT}$	Stress for tapered members defined by Equation A-F3-7, ksi (MPa) . . . . .	App. F3
$F_y$	Specified minimum yield stress of the type of steel being used, ksi (MPa). As used in this Specification, “yield stress” denotes either the specified minimum yield point (for those steels that have a yield point) or specified yield	

	strength (for those steels that do not have a yield point) . . . . .	A5
$F_{yf}$	Specified minimum yield stress of the flange, ksi (MPa) . . . . .	B5.1
$F_{yr}$	Specified minimum yield stress of reinforcing bars, ksi (MPa) . . . . .	I2.2
$F_{yst}$	Specified minimum yield stress of the stiffener material, ksi (MPa) . . . . .	App. G4
$F_{yw}$	Specified minimum yield stress of the web, ksi (MPa) . . . . .	B5.1
$G$	Shear modulus of elasticity of steel, $G = 11,200$ ksi (77 200 MPa) . . . . .	F1.2
$H$	Horizontal force, kips (N) . . . . .	C1
$H$	Flexural constant . . . . .	E3
$H_s$	Length of stud connector after welding, in. (mm) . . . . .	I3.5
$I$	Moment of inertia, in. <sup>4</sup> (mm <sup>4</sup> ) . . . . .	F1.2
$I_d$	Moment of inertia of the steel deck supported on secondary members, in. <sup>4</sup> (mm <sup>4</sup> ) . . . . .	K2
$I_p$	Moment of inertia of primary members, in. <sup>4</sup> (mm <sup>4</sup> ) . . . . .	K2
$I_s$	Moment of inertia of secondary members, in. <sup>4</sup> (mm <sup>4</sup> ) . . . . .	K2
$I_{st}$	Moment of inertia of a transverse stiffener, in. <sup>4</sup> (mm <sup>4</sup> ) . . . . .	App. G4
$I_{yc}$	Moment of inertia about y-axis referred to compression flange, or if reverse curvature bending referred to smaller flange, in. <sup>4</sup> (mm <sup>4</sup> ) . . . . .	App. F1
$J$	Torsional constant for a section, in. <sup>4</sup> (mm <sup>4</sup> ) . . . . .	F1.2
$K$	Effective length factor for prismatic member . . . . .	B7
$K_z$	Effective length factor for torsional buckling . . . . .	App. E3
$K_\gamma$	Effective length factor for a tapered member . . . . .	App. F3
$L$	Story height or panel spacing, in. (mm) . . . . .	C1
$L$	Length of connection in the direction of loading, in. (mm) . . . . .	B3
$L$	Live load due to occupancy and moveable equipment . . . . .	N4
$L_b$	Laterally unbraced length; length between points which are either braced against lateral displacement of compression flange or braced against twist of the cross section, in. (mm) . . . . .	F1.2
$L_c$	Length of channel shear connector, in. (mm) . . . . .	I5.4
$L_c$	Edge distance, in. (mm) . . . . .	J3.10
$L_p$	Limiting laterally unbraced length for full plastic bending capacity, uniform moment case ( $C_b = 1.0$ ), in. (mm) . . . . .	F1.2
$L_p$	Column spacing in direction of girder, ft (m) . . . . .	K2
$L_{pd}$	Limiting laterally unbraced length for plastic analysis, in. (m) . . . . .	F1.2
$L_q$	Maximum unbraced length for the required column force with $K$ equal to one, in. (mm) . . . . .	C3
$L_r$	Limiting laterally unbraced length for inelastic lateral- torsional buckling, in. (mm) . . . . .	F1.2
$L_r$	Roof live load . . . . .	N4
$L_s$	Column spacing perpendicular to direction of girder, ft (m) . . . . .	K2
$M_A$	Absolute value of moment at quarter point of the unbraced beam segment, kip-in. (N-mm) . . . . .	F1.2
$M_B$	Absolute value of moment at centerline of the unbraced beam segment, kip-in. (N-mm) . . . . .	F1.2
$M_C$	Absolute value of moment at three-quarter point of the unbraced beam segment, kip-in. (N-mm) . . . . .	F1.2
$M_{cr}$	Elastic buckling moment, kip-in. (N-mm) . . . . .	F1.2

$M_{lr}$	Required flexural strength in member due to lateral frame translation only, kip-in. (N-mm) . . . . .	C1
$M_{max}$	Absolute value of maximum moment in the unbraced beam segment, kip-in. (N-mm) . . . . .	F1.2
$M_n$	Nominal flexural strength, kip-in. (N-mm) . . . . .	F1.1
$M'_{nx}$ , $M'_{ny}$	Flexural strength defined in Equations A-H3-7 and A-H3-8 for use in alternate interaction equations for combined bending and axial force, kip-in. (N-mm) . . . . .	App. H3
$M_{nt}$	Required flexural strength in member assuming there is no lateral translation of the frame, kip-in. (N-mm) . . . . .	C1
$M_p$	Plastic bending moment, kip-in. (N-mm) . . . . .	F1.1
$M_p$	Moment defined in Equations A-H3-5 and A-H3-6, for use in alternate interaction equations for combined bending and axial force, kip-in. (N-mm) . . . . .	App. H3
$M_r$	Limiting buckling moment, $M_{cr}$ , when $\lambda = \lambda_r$ and $C_b = 1.0$ , kip-in. (N-mm) . . . . .	F1.2
$M_u$	Required flexural strength, kip-in. (N-mm) . . . . .	C1
$M_y$	Moment corresponding to onset of yielding at the extreme fiber from an elastic stress distribution ( $= F_y S$ for homogeneous sections), kip-in. (N-mm) . . . . .	F1.1
$M_1$	Smaller moment at end of unbraced length of beam or beam-column, kip-in. (N-mm) . . . . .	F1.2
$M_2$	Larger moment at end of unbraced length of beam or beam-column, kip-in. (N-mm) . . . . .	F1.2
$N$	Length of bearing, in. (mm) . . . . .	K1.3
$N$	Number of stress range fluctuations in design life . . . . .	App. K3.3
$N_r$	Number of stud connectors in one rib at a beam intersection. . . . .	I3.5
$P_{br}$	Required story or panel bracing shear force, kip (N) . . . . .	C3
$P_{e1}$ , $P_{e2}$	Elastic Euler buckling load for braced and unbraced frame, respectively, kips (N) . . . . .	C1
$P_n$	Nominal axial strength (tension or compression), kips (N) . . . . .	D1
$P_p$	Bearing load on concrete, kips (N) . . . . .	J9
$P_u$	Required axial strength (tension or compression), kips (N) . . . . .	B5.1
$P_y$	Yield strength, kips (N) . . . . .	B5.1
$Q$	Full reduction factor for slender compression elements . . . . .	App. E3
$Q_a$	Reduction factor for slender stiffened compression elements . . . . .	App. B5
$Q_n$	Nominal strength of one stud shear connector, kips (N) . . . . .	I5
$Q_s$	Reduction factor for slender unstiffened compression elements . . . . .	App. B5.3
$R$	Nominal load due to initial rainwater or ice exclusive of the ponding contribution . . . . .	N4
$R_{PG}$	Plate girder bending strength reduction factor . . . . .	App. G
$R_e$	Hybrid girder factor . . . . .	App. F1
$R_n$	Nominal strength . . . . .	A5.3
$R_v$	Web shear strength, kips (N) . . . . .	K1.7
$S$	Elastic section modulus, in. <sup>3</sup> (mm <sup>3</sup> ) . . . . .	F1.2
$S$	Spacing of secondary members, ft (m) . . . . .	K2
$S$	Snow load . . . . .	N4
$S'_x$	Elastic section modulus of larger end of tapered member about its major axis, in. <sup>3</sup> (mm <sup>3</sup> ) . . . . .	App. F3

$S_{eff}$	Effective section modulus about major axis, in. <sup>3</sup> (mm <sup>3</sup> ) . . . . .	App. F1
$S_{xt}, S_{xc}$	Elastic section modulus referred to tension and compression flanges, respectively, in. <sup>3</sup> (mm <sup>3</sup> ). . . . .	App. F1
$T$	Tension force due to service loads, kips (N) . . . . .	J3.9
$T_b$	Specified pretension load in high-strength bolt, kips (N). . . . .	J3.9
$T_u$	Required tensile strength due to factored loads, kips (N). . . . .	J3.9
$U$	Reduction coefficient, used in calculating effective net area . . . . .	B3
$V_n$	Nominal shear strength, kips (N) . . . . .	F2.2
$V_u$	Required shear strength, kips (N) . . . . .	App. G4
$W$	Wind load . . . . .	Comm. A4
$X_1$	Beam buckling factor defined by Equation F1-8 . . . . .	F1.2
$X_2$	Beam buckling factor defined by Equation F1-9 . . . . .	F1.2
$Z$	Plastic section modulus, in. <sup>3</sup> (mm <sup>3</sup> ). . . . .	F1.1
$a$	Clear distance between transverse stiffeners, in. (mm). . . . .	App. F2.2
$a$	Distance between connectors in a built-up member, in. (mm) . . . .	E4
$a$	Shortest distance from edge of pin hole to edge of member measured parallel to direction of force, in. (mm) . . . . .	D3
$a_r$	Ratio of web area to compression flange area . . . . .	App. G2
$a'$	Weld length, in. (mm). . . . .	B10
$b$	Compression element width, in. (mm) . . . . .	B5.1
$b_e$	Reduced effective width for slender compression elements, in. (mm) . . . . .	App. B5.3
$b_{eff}$	Effective edge distance, in. (mm) . . . . .	D3
$b_f$	Flange width, in. (mm) . . . . .	B5.1
$b_s$	Stiffener width for one-sided stiffeners, in. (mm) . . . . .	C3.4
$c_1, c_2, c_3$	Numerical coefficients . . . . .	I2.2
$d$	Nominal fastener diameter, in. (mm) . . . . .	J3.3
$d$	Overall depth of member, in. (mm) . . . . .	B5.1
$d$	Pin diameter, in. (mm) . . . . .	D3
$d$	Roller diameter, in. (mm) . . . . .	J8.2
$d_L$	Depth at larger end of unbraced tapered segment, in. (mm) . . . .	App. F3
$d_b$	Beam depth, in. (mm) . . . . .	K1.7
$d_b$	Nominal diameter (body or shank diameter), in. (mm). . . . .	App. K3.3
$d_c$	Column depth, in. (mm). . . . .	K1.7
$d_o$	Depth at smaller end of unbraced tapered segment, in. (mm) . . . .	App. F3
$e$	Base of natural logarithm = 2.71828. . . . .	Comm. E2
$f$	Computed compressive stress in the stiffened element, ksi (MPa) .	App. B5.3
$f_{b1}$	Smallest computed bending stress at one end of a tapered segment, ksi (MPa) . . . . .	App. F3
$f_{b2}$	Largest computed bending stress at one end of a tapered segment, ksi (MPa) . . . . .	App. F3
$f'_c$	Specified compressive strength of concrete, ksi (MPa). . . . .	I2.2
$f_o$	Stress due to $1.2D + 1.2R$ , ksi (MPa) . . . . .	App. K2
$f_{un}$	Required normal stress, ksi (MPa) . . . . .	H2
$f_{uv}$	Required shear stress, ksi (MPa) . . . . .	H2
$f_v$	Required shear stress due to factored loads in bolts or rivets, ksi (MPa) . . . . .	J3.7
$g$	Transverse center-to-center spacing (gage) between fastener gage lines, in. (mm) . . . . .	B2
$h$	Clear distance between flanges less the fillet or corner radius for	

rolled shapes; and for built-up sections, the distance between adjacent lines of fasteners or the clear distance between flanges when welds are used, in. (mm) . . . . . B5.1

$h$  Distance between centroids of individual components perpendicular to the member axis of buckling, in. (mm). . . . . E4

$h_c$  Twice the distance from the centroid to the following: the inside face of the compression flange less the fillet or corner radius, for rolled shapes; the nearest line of fasteners at the compression flange or the inside faces of the compression flange when welds are used, for built-up sections, in. (mm) . . . . . B5.1

$h_o$  Distance between flange centroids, in. (mm) . . . . . C3

$h_r$  Nominal rib height, in. (mm) . . . . . I3.5

$h_s$  Factor used in Equation A-F3-6 for web-tapered members. . . . . App. F3

$h_w$  Factor used in Equation A-F3-7 for web-tapered members. . . . . App. F3

$j$  Factor defined by Equation A-F2-4 for minimum moment of inertia for a transverse stiffener . . . . . App. F2.3

$k$  Distance from outer face of flange to web toe of fillet, in. (mm) . . . . . K1.3

$k_v$  Web plate buckling coefficient . . . . . App. F2.2

$l$  Laterally unbraced length of member at the point of load, in. (mm) B7

$l$  Length of bearing, in. (mm). . . . . J8.2

$l$  Length of connection in the direction of loading, in. (mm). . . . . B3

$l$  Length of weld, in. (mm) . . . . . B3

$m$  Ratio of web to flange yield stress or critical stress in hybrid beams . . . . . App. G2

$n$  Number of nodal braced points within the span . . . . . C3

$n$  Threads per inch (per mm) . . . . . App. K3.4

$r$  Governing radius of gyration, in. (mm). . . . . B7

$r_{To}$  For the smaller end of a tapered member, the radius of gyration, considering only the compression flange plus one-third of the compression web area, taken about an axis in the plane of the web, in. (mm) . . . . . App. F3.4

$r_i$  Minimum radius of gyration of individual component in a built-up member, in. (mm) . . . . . E4

$r_{ib}$  Radius of gyration of individual component relative to centroidal axis parallel to member axis of buckling, in. (mm). . . . . E4

$r_m$  Radius of gyration of the steel shape, pipe, or tubing in composite columns. For steel shapes it may not be less than 0.3 times the overall thickness of the composite section, in. (mm) . . . . . I2

$\bar{r}_o$  Polar radius of gyration about the shear center, in. (mm). . . . . E3

$r_{ox}, r_{oy}$  Radius of gyration about x and y axes at the smaller end of a tapered member, respectively, in. (mm). . . . . App. F3.3

$r_x, r_y$  Radius of gyration about x and y axes, respectively, in. (mm) . . . . . E3

$r_{yc}$  Radius of gyration about y axis referred to compression flange, or if reverse curvature bending, referred to smaller flange, in. (mm) . . . . . App. F1

$s$  Longitudinal center-to-center spacing (pitch) of any two consecutive holes, in. (mm) . . . . . B2

$t$  Thickness of element, in. (mm). . . . . B5.1

$t$  HSS design wall thickness, in. (mm) . . . . . B5.1

$t_f$  Flange thickness, in. (mm) . . . . . B5.1

$t_f$  Flange thickness of channel shear connector, in. (mm). . . . . I5.4

$t_s$	Web stiffener thickness, in. (mm) . . . . .	C3.4
$t_w$	Web thickness of channel shear connector, in. (mm) . . . . .	I5.4
$t_w$	Web thickness, in. (mm) . . . . .	B5.3
$w$	Leg size of the fillet weld, in. (mm). . . . .	J2.2
$w$	Plate width; distance between welds, in. (mm). . . . .	B3
$w$	Unit weight of concrete, lbs/cu ft. (kg/m <sup>3</sup> ) . . . . .	I2
$w_r$	Average width of concrete rib or haunch, in. (mm). . . . .	I3.5
$x$	Subscript relating symbol to member strong axis	
$x_o, y_o$	Coordinates of the shear center with respect to the centroid, in. (mm) . . . . .	E3
$\bar{x}$	Connection eccentricity, in. (mm). . . . .	B3
$y$	Subscript relating symbol to member weak axis	
$z$	Distance from the smaller end of tapered member used in Equation A-F3-1 for the variation in depth, in. (mm). . . . .	App. F3
$z$	Subscript relating symbol to member longitudinal axis	
$\alpha$	Separation ratio for built-up compression members = $h / 2r_{ib}$ . . . . .	E4
$\beta$	Reduction factor given by Equation J2-1 . . . . .	J2
$\beta_T$	Brace stiffness requirement when there is no web distortion . . . . .	C3.4
$\beta_{Tb}$	Required nodal torsional bracing stiffness . . . . .	C3.4
$\beta_{br}$	Required story or panel shear stiffness . . . . .	C3
$\beta_{sec}$	Web distortional stiffness, including the effect of web transverse stiffeners, if any . . . . .	C3.4
$\Delta_{oh}$	Translation deflection of the story under consideration, in. (mm) . . . . .	C1
$\gamma$	Depth tapering ratio . . . . .	App. F3
$\gamma$	Subscript for tapered members . . . . .	App. F3
$\zeta$	Exponent for alternate beam-column interaction equation . . . . .	App. H3
$\eta$	Exponent for alternate beam-column interaction equation . . . . .	App. H3
$\lambda_c$	Column slenderness parameter . . . . .	C1
$\lambda_e$	Equivalent slenderness parameter. . . . .	App. E3
$\lambda_{eff}$	Effective slenderness ratio defined by Equation A-F3-2 . . . . .	App. F3
$\lambda_p$	Limiting slenderness parameter for compact element . . . . .	B5.1
$\lambda_r$	Limiting slenderness parameter for noncompact element . . . . .	B5.1
$\phi$	Resistance factor . . . . .	A5.3
$\phi_b$	Resistance factor for flexure . . . . .	F1
$\phi_c$	Resistance factor for compression . . . . .	A5.1
$\phi_c$	Resistance factor for axially loaded composite columns . . . . .	I2.2
$\phi_{sf}$	Resistance factor for shear on the failure path . . . . .	D3
$\phi_t$	Resistance factor for tension . . . . .	D1
$\phi_v$	Resistance factor for shear . . . . .	F2.2



## GLOSSARY

*Alignment chart for columns.* A nomograph for determining the effective length factor  $K$  for some types of columns

*Amplification factor.* A multiplier of the value of moment or deflection in the unbraced length of an axially loaded member to reflect the secondary values generated by the eccentricity of the applied axial load within the member

*Aspect ratio.* In any rectangular configuration, the ratio of the lengths of the sides

*Batten plate.* A plate element used to join two parallel components of a built-up column, girder, or strut rigidly connected to the parallel components and designed to transmit shear between them

*Beam.* A structural member whose primary function is to carry loads transverse to its longitudinal axis

*Beam-column.* A structural member whose primary function is to carry loads both transverse and parallel to its longitudinal axis

*Bent.* A plane framework of beam or truss members which support loads and the columns which support these members

*Biaxial bending.* Simultaneous bending of a member about two perpendicular axes

*Bifurcation.* The phenomenon whereby a perfectly straight member under compression may either assume a deflected position or may remain undeflected, or a beam under flexure may either deflect and twist out of plane or remain in its in-plane deflected position

*Braced frame.* A frame in which the resistance to lateral load or frame instability is primarily provided by a diagonal, a  $K$  brace, or other auxiliary system of bracing

*Brittle fracture.* Abrupt cleavage with little or no prior ductile deformation

*Buckling load.* The load at which a perfectly straight member under compression assumes a deflected position

*Built-up member.* A member made of structural metal elements that are welded, bolted, or riveted together

*Charpy V-notch impact test.* A standard dynamic test in which a notched specimen is struck and broken by a single blow in a specially designed testing machine. The measured test values may be the energy absorbed, the percentage shear fracture, the lateral expansion opposite the notch, or a combination thereof

*Cladding.* The exterior covering of the structural components of a building

*Cold-formed members.* Structural members formed from steel without the application of heat

*Column.* A structural member whose primary function is to carry loads parallel to its longitudinal axis



- Column curve.* A curve expressing the relationship between axial column strength and slenderness ratio
- Combined mechanism.* A mechanism determined by plastic analysis procedure which combines elementary beam, panel, and joint mechanisms
- Compact section.* Compact sections are capable of developing a fully plastic stress distribution and possess rotation capacity of approximately three before the onset of local buckling
- Composite beam.* A steel beam structurally connected to a concrete slab so that the beam and slab respond to loads as a unit
- Concrete-encased beam.* A beam totally encased in concrete cast integrally with the slab
- Connection.* Combination of joints used to transmit forces between two or more members. Categorized by the type and amount of force transferred (moment, shear, end reaction). See also *Splices*
- Critical load.* The load at which bifurcation occurs as determined by a theoretical stability analysis
- Curvature.* Rotation per unit length due to bending
- Design documents.* Documents prepared by the designer (design drawings, design details, and job specifications)
- Design strength.* Resistance (force, moment, stress, as appropriate) provided by element or connection; the product of the nominal strength and the resistance factor
- Diagonal bracing.* Inclined structural members carrying primarily axial load enabling a structural frame to act as a truss to resist horizontal loads
- Diaphragm.* Floor slab, metal wall, or roof panel possessing a large in-plane shear stiffness and strength adequate to transmit horizontal forces to resisting systems
- Diaphragm action.* The in-plane action of a floor system (also roofs and walls) such that all columns framing into the floor from above and below are maintained in the same position relative to each other
- Double concentrated forces.* Two equal and opposite forces which form a couple on the same side of the loaded member
- Double curvature.* A bending condition in which end moments on a member cause the member to assume an S shape
- Drift.* Lateral deflection of a building
- Drift index.* The ratio of lateral deflection to the height of the building
- Ductility factor.* The ratio of the total deformation at maximum load to the elastic-limit deformation
- Effective length.* The equivalent length  $KL$  used in compression formulas and determined by a bifurcation analysis
- Effective length factor  $K$ .* The ratio between the effective length and the unbraced length of the member measured between the centers of gravity of the bracing members

*Effective moment of inertia.* The moment of inertia of the cross section of a member that remains elastic when partial plastification of the cross section takes place, usually under the combination of residual stress and applied stress. Also, the moment of inertia based on effective widths of elements that buckle locally. Also, the moment of inertia used in the design of partially composite members

*Effective stiffness.* The stiffness of a member computed using the effective moment of inertia of its cross section

*Effective width.* The reduced width of a plate or slab which, with an assumed uniform stress distribution, produces the same effect on the behavior of a structural member as the actual plate width with its nonuniform stress distribution

*Elastic analysis.* Determination of load effects (force, moment, stress, as appropriate) on members and connections based on the assumption that material deformation disappears on removal of the force that produced it

*Elastic-perfectly plastic.* A material which has an idealized stress-strain curve that varies linearly from the point of zero strain and zero stress up to the yield point of the material, and then increases in strain at the value of the yield stress without any further increases in stress

*Embedment.* A steel component cast in a concrete structure which is used to transmit externally applied loads to the concrete structure by means of bearing, shear, bond, friction, or any combination thereof. The embedment may be fabricated of structural-steel plates, shapes, bars, bolts, pipe, studs, concrete reinforcing bars, shear connectors, or any combination thereof

*Encased steel structure.* A steel-framed structure in which all of the individual frame members are completely encased in cast-in-place concrete

*Euler formula.* The mathematical relationship expressing the value of the Euler load in terms of the modulus of elasticity, the moment of inertia of the cross section, and the length of a column

*Euler load.* The critical load of a perfectly straight, centrally loaded pin-ended column

*Eyebar.* A particular type of pin-connected tension member of uniform thickness with forged or flame-cut head of greater width than the body proportioned to provide approximately equal strength in the head and body

*Factored load.* The product of the nominal load and a load factor

*Fastener.* Generic term for welds, bolts, rivets, or other connecting device

*Fatigue.* A fracture phenomenon resulting from a fluctuating stress cycle

*First-order analysis.* Analysis based on first-order deformations in which equilibrium conditions are formulated on the undeformed structure

*Flame-cut plate.* A plate in which the longitudinal edges have been prepared by oxygen cutting from a larger plate

*Flat width.* For a rectangular HSS, the nominal width minus twice the outside corner radius. In absence of knowledge of the corner radius, the flat width may be taken as the total section width minus three times the thickness

- Flexible connection.* A connection permitting a portion, but not all, of the simple beam rotation of a member end
- Floor system.* The system of structural components separating the stories of a building
- Force.* Resultant of distribution of stress over a prescribed area. A reaction that develops in a member as a result of load (formerly called total stress or stress). Generic term signifying axial loads, bending moment, torques, and shears
- Fracture toughness.* Measure of the ability to absorb energy without fracture. Generally determined by impact loading of specimens containing a notch having a prescribed geometry
- Frame buckling.* A condition under which bifurcation may occur in a frame
- Frame instability.* A condition under which a frame deforms with increasing lateral deflection under a system of increasing applied monotonic loads until a maximum value of the load called the stability limit is reached, after which the frame will continue to deflect without further increase in load
- Fully composite beam.* A composite beam with sufficient shear connectors to develop the full flexural strength of the composite section
- High-cycle fatigue.* Failure resulting from more than 20,000 applications of cyclic stress
- HSS.* Hollow structural sections that are prismatic square, rectangular or round products of a pipe or tubing mill and meet the geometric tolerance, tensile strength and chemical composition requirements of a standard specification
- Hybrid beam.* A fabricated steel beam composed of flanges with a greater yield strength than that of the web. Whenever the maximum flange stress is less than or equal to the web yield stress the girder is considered homogeneous
- Hysteresis loop.* A plot of force versus displacement of a structure or member subjected to reversed, repeated load into the inelastic range, in which the path followed during release and removal of load is different from the path for the addition of load over the same range of displacement
- Inclusions.* Nonmetallic material entrapped in otherwise sound metal
- Incomplete fusion.* Lack of union by melting of filler and base metal over entire prescribed area
- Inelastic action.* Material deformation that does not disappear on removal of the force that produced it
- Instability.* A condition reached in the loading of an element or structure in which continued deformation results in a decrease of load-resisting capacity
- Joint.* Area where two or more ends, surfaces, or edges are attached. Categorized by type of fastener or weld used and method of force transfer
- K bracing.* A system of struts used in a braced frame in which the pattern of the struts resembles the letter K, either normal or on its side
- Lamellar tearing.* Separation in highly restrained base metal caused by through-thickness strains induced by shrinkage of adjacent filler metal

*Lateral bracing member.* A member utilized individually or as a component of a lateral bracing system to prevent buckling of members or elements and/or to resist lateral loads

*Lateral (or lateral-torsional) buckling.* Buckling of a member involving lateral deflection and twist

*Leaning column.* Gravity-loaded column where connections to the frame (simple connections) do not provide resistance to lateral loads

*Limit state.* A condition in which a structure or component becomes unfit for service and is judged either to be no longer useful for its intended function (*serviceability limit state*) or to be unsafe (*strength limit state*)

*Limit states.* Limits of structural usefulness, such as brittle fracture, plastic collapse, excessive deformation, durability, fatigue, instability, and serviceability

*Load factor.* A factor that accounts for unavoidable deviations of the actual load from the nominal value and for uncertainties in the analysis that transforms the load into a load effect

*Loads.* Forces or other actions that arise on structural systems from the weight of all permanent construction, occupants and their possessions, environmental effects, differential settlement, and restrained dimensional changes. *Permanent* loads are those loads in which variations in time are rare or of small magnitude. All other loads are *variable* loads. See *Nominal loads*

*LRFD (Load and Resistance Factor Design).* A method of proportioning structural components (members, connectors, connecting elements, and assemblages) such that no applicable limit state is exceeded when the structure is subjected to all appropriate load combinations

*Local buckling.* The buckling of a compression element which may precipitate the failure of the whole member

*Low-cycle fatigue.* Fracture resulting from a relatively high-stress range resulting in a relatively small number of cycles to failure

*Lower bound load.* A load computed on the basis of an assumed equilibrium moment diagram in which the moments are not greater than  $M_p$  that is less than or at best equal to the true ultimate load

*Mechanism.* An articulated system able to deform without an increase in load, used in the special sense that the linkage may include real hinges or plastic hinges, or both

*Mechanism method.* A method of plastic analysis in which equilibrium between external forces and internal plastic hinges is calculated on the basis of an assumed mechanism. The failure load so determined is an upper bound

*Nodal Brace.* A brace that prevents the lateral movement or twist at the particular brace location along the length of the beam or column without any direct attachment to other braces at adjacent brace points. (See relative brace)

*Nominal loads.* The magnitudes of the loads specified by the applicable code

*Nominal strength.* The capacity of a structure or component to resist the effects of loads,

as determined by computations using specified material strengths and dimensions and formulas derived from accepted principles of structural mechanics or by field tests or laboratory tests of scaled models, allowing for modeling effects and differences between laboratory and field conditions

*Noncompact section.* Noncompact sections can develop the yield stress in compression elements before local buckling occurs, but will not resist inelastic local buckling at strain levels required for a fully plastic stress distribution

*P-Delta effect.* Secondary effect of column axial loads and lateral deflection on the moments in members

*Panel zone.* The zone in a beam-to-column connection that transmits moment by a shear panel

*Partially composite beam.* A composite beam for which the shear strength of shear connectors governs the flexural strength

*Plane frame.* A structural system assumed for the purpose of analysis and design to be two-dimensional

*Plastic analysis.* Determination of load effects (force, moment, stress, as appropriate) on members and connections based on the assumption of rigid-plastic behavior, i.e., that equilibrium is satisfied throughout the structure and yield is not exceeded anywhere. Second order effects may need to be considered

*Plastic design section.* The cross section of a member which can maintain a full plastic moment through large rotations so that a mechanism can develop; the section suitable for design by plastic analysis

*Plastic hinge.* A yielded zone which forms in a structural member when the plastic moment is attained. The beam is assumed to rotate as if hinged, except that it is restrained by the plastic moment  $M_p$

*Plastic-limit load.* The maximum load that is attained when a sufficient number of yield zones have formed to permit the structure to deform plastically without further increase in load. It is the largest load a structure will support, when perfect plasticity is assumed and when such factors as instability, second-order effects, strain hardening, and fracture are neglected

*Plastic mechanism.* See *Mechanism*

*Plastic modulus.* The section modulus of resistance to bending of a completely yielded cross section. It is the combined static moment about the plastic neutral axis of the cross-sectional areas above and below that axis

*Plastic moment.* The resisting moment of a fully-yielded cross section

*Plastic strain.* The difference between total strain and elastic strain

*Plastic zone.* The yielded region of a member

*Plastification.* The process of successive yielding of fibers in the cross section of a member as bending moment is increased

*Plate girder.* A built-up structural beam

*Post-buckling strength.* The load that can be carried by an element, member, or frame after buckling

*Prying Action.* Lever action that exists in connections in which the line of application of the applied load is eccentric to the axis of the bolt, causing deformation of the fitting and an amplification of the axial force in the bolt

*Redistribution of moment.* A process which results in the successive formation of plastic hinges so that less highly stressed portions of a structure may carry increased moments

*Relative Brace.* A brace that controls the relative movement of two adjacent brace points along the length of a beam or column or the relative lateral displacement of two stories in a frame. (See nodal brace)

*Required strength.* Load effect (force, moment, stress, as appropriate) acting on element or connection determined either by structural analysis from the factored loads (using appropriate critical load combinations) or explicitly specified

*Residual stress.* The stresses that remain in an unloaded member after it has been formed into a finished product. (Examples of such stresses include, but are not limited to, those induced by cold bending, cooling after rolling, or welding)

*Resistance.* The capacity of a structure or component to resist the effects of loads. It is determined by computations using specified material strengths, dimensions and formulas derived from accepted principles of structural mechanics, or by field tests or laboratory tests of scaled models, allowing for modeling effects and differences between laboratory and field conditions. Resistance is a generic term that includes both strength and serviceability limit states

*Resistance factor.* A factor that accounts for unavoidable deviations of the actual strength from the nominal value and the manner and consequences of failure

*Rigid frame.* A structure in which connections maintain the angular relationship between beam and column members under load

*Root of the flange.* Location on the web of the corner radius termination point or the toe of the flange-to-web weld. Measured as the  $k$  distance from the far side of the flange

*Rotation capacity.* The incremental angular rotation that a given shape can accept prior to local failure defined as  $R = (\theta_u / \theta_p)$  where  $\theta_u$  is the overall rotation attained at the factored load state and  $\theta_p$  is the idealized rotation corresponding to elastic theory applied to the case of  $M = M_p$

*St. Venant torsion.* That portion of the torsion in a member that induces only shear stresses in the member

*Second-order analysis.* Analysis based on second-order deformations, in which equilibrium conditions are formulated on the deformed structure

*Service load.* Load expected to be supported by the structure under normal usage; often taken as the nominal load

*Serviceability limit state.* Limiting condition affecting the ability of a structure to preserve its appearance, maintainability, durability, or the comfort of its occupants or function of machinery under normal usage

- Shape factor.* The ratio of the plastic moment to the yield moment, or the ratio of the plastic modulus to the section modulus for a cross section
- Shear friction.* Friction between the embedment and the concrete that transmits shear loads. The relative displacement in the plane of the shear load is considered to be resisted by shear-friction anchors located perpendicular to the plane of the shear load
- Shear lugs.* Plates, welded studs, bolts, and other steel shapes that are embedded in the concrete and located transverse to the direction of the shear force and that transmit shear loads, introduced into the concrete by local bearing at the shear lug-concrete interface
- Shear wall.* A wall that resists, in its own plane, shear forces resulting from applied wind, earthquake, or other transverse loads or provides frame stability. Also called a structural wall
- Sidesway.* The lateral movement of a structure under the action of lateral loads, unsymmetrical vertical loads, or unsymmetrical properties of the structure
- Sidesway buckling.* The buckling mode of a multistory frame precipitated by the relative lateral displacements of joints, leading to failure by sidesway of the frame
- Simple plastic theory.* See *Plastic design*
- Single curvature.* A deformed shape of a member having one smooth continuous arc, as opposed to double curvature which contains a reversal
- Slender-element section.* The cross section of a member which will experience local buckling in the elastic range
- Slenderness ratio.* The ratio of the effective length of a column to the radius of gyration of the column, both with respect to the same axis of bending
- Slip-critical joint.* A bolted joint in which the slip resistance of the connection is required
- Space frame.* A three-dimensional structural framework (as contrasted to a plane frame)
- Splice.* The connection between two structural elements joined at their ends to form a single, longer element
- Stability-limit load.* Maximum (theoretical) load a structure can support when second-order instability effects are included
- Stepped column.* A column with changes from one cross section to another occurring at abrupt points within the length of the column
- Stiffener.* A member, usually an angle or plate, attached to a plate or web of a beam or girder to distribute load, to transfer shear, or to prevent buckling of the member to which it is attached
- Stiffness.* The resistance to deformation of a member or structure measured by the ratio of the applied force to the corresponding displacement
- Story drift.* The difference in horizontal deflection at the top and bottom of a story
- Strain hardening.* Phenomenon wherein ductile steel, after undergoing considerable deformation at or just above yield point, exhibits the capacity to resist substantially higher loading than that which caused initial yielding

*Strain-hardening strain.* For structural steels that have a flat (plastic) region in the stress-strain relationship, the value of the strain at the onset of strain hardening

*Strength design.* A method of proportioning structural members using load factors and resistance factors such that no applicable limit state is exceeded (also called load and resistance factor design)

*Strength limit state.* Limiting condition affecting the safety of the structure, in which the ultimate load-carrying capacity is reached

*Stress.* Force per unit area

*Stress concentration.* Localized stress considerably higher than average (even in uniformly loaded cross sections of uniform thickness) due to abrupt changes in geometry or localized loading

*Strong axis.* The major principal axis of a cross section

*Structural system.* An assemblage of load-carrying components which are joined together to provide regular interaction or interdependence

*Stub column.* A short compression-test specimen, long enough for use in measuring the stress-strain relationship for the complete cross section, but short enough to avoid buckling as a column in the elastic and plastic ranges

*Subassemblage.* A truncated portion of a structural frame

*Supported frame.* A frame which depends upon adjacent braced or unbraced frames for resistance to lateral load or frame instability. (This transfer of load is frequently provided by the floor or roof system through diaphragm action or by horizontal cross bracing in the roof)

*Tangent modulus.* At any given stress level, the slope of the stress-strain curve of a material in the inelastic range as determined by the compression test of a small specimen under controlled conditions

*Temporary structure.* A general term for anything that is built or constructed (usually to carry construction loads) that will eventually be removed before or after completion of construction and does not become part of the permanent structural system

*Tensile strength.* The maximum tensile stress that a material is capable of sustaining

*Tension field action.* The behavior of a plate girder panel under shear force in which diagonal tensile stresses develop in the web and compressive forces develop in the transverse stiffeners in a manner analogous to a Pratt truss

*Toe of the fillet.* Termination point of fillet weld or of rolled section fillet

*Torque-tension relationship.* Term applied to the wrench torque required to produce specified pre-tension in high-strength bolts

*Turn-of-nut method.* Procedure whereby the specified pre-tension in high-strength bolts is controlled by rotation of the wrench a predetermined amount after the nut has been tightened to a snug fit

*Unbraced frame.* A frame in which the resistance to lateral load is provided by the bending resistance of frame members and their connections



*Unbraced length.* The distance between braced points of a member, measured between the centers of gravity of the bracing members

*Undercut.* A notch resulting from the melting and removal of base metal at the edge of a weld

*Universal-mill plate.* A plate in which the longitudinal edges have been formed by a rolling process during manufacture. Often abbreviated as UM plate

*Upper bound load.* A load computed on the basis of an assumed mechanism which will always be at best equal to or greater than the true ultimate load

*Vertical bracing system.* A system of shear walls, braced frames, or both, extending through one or more floors of a building

*Von Mises yield criterion.* A theory which states that inelastic action at any point in a body under any combination of stresses begins only when the strain energy of distortion per unit volume absorbed at the point is equal to the strain energy of distortion absorbed per unit volume at any point in a simple tensile bar stressed to the elastic limit under a state of uniaxial stress. It is often called the maximum strain-energy-of-distortion theory. Accordingly, shear yield occurs at 0.58 times the yield strength

*Warping torsion.* That portion of the total resistance to torsion that is provided by resistance to warping of the cross section

*Weak axis.* The minor principal axis of a cross section

*Weathering steel.* A type of high-strength, low-alloy steel which can be used in normal environments (not marine) and outdoor exposures without protective paint covering. This steel develops a tight adherent rust at a decreasing rate with respect to time

*Web buckling.* The buckling of a web plate

*Web crippling.* The local failure of a web plate in the immediate vicinity of a concentrated load or reaction

*Working load.* Also called service load. The actual load assumed to be acting on the structure

*Yield moment.* In a member subjected to bending, the moment at which an outer fiber first attains the yield stress

*Yield plateau.* The portion of the stress-strain curve for uniaxial tension or compression in which the stress remains essentially constant during a period of substantially increased strain

*Yield point.* The first stress in a material at which an increase in strain occurs without an increase in stress

*Yield strength.* The stress at which a material exhibits a specified limiting deviation from the proportionality of stress to strain. Deviation expressed in terms of strain

*Yield stress.* Yield point, yield strength, or yield stress level as defined

*Yield-stress level.* The average stress during yielding in the plastic range, the stress determined in a tension test when the strain reaches 0.005 in. per in. (0.005 mm per mm)

# CHAPTER A

## GENERAL PROVISIONS

### A1. SCOPE

The *Load and Resistance Factor Design Specification for Structural Steel Buildings* shall govern the design, fabrication, and erection of steel-framed buildings. As an alternative, the *AISC Specification for Structural Steel Buildings, Allowable Stress Design and Plastic Design* is permitted.

This Specification includes the list of symbols, the glossary, and the appendices. The tables of numerical values are provided for design convenience.

Seismic design of buildings shall comply with the *AISC Seismic Provisions for Structural Steel Buildings, Seismic Provisions Supplement No. 1*, and with this Specification.

Single angle members shall comply with the *Specification for Load and Resistance Factor Design of Single-Angle Members* and with this Specification.

Hollow structural sections (HSS) shall comply with the *Specification for the Design of Steel Hollow Structural Sections* and with this Specification.

Design of nuclear structures shall comply with the *Specification for the Design, Fabrication and Erection of Steel Safety Related Structures for Nuclear Facilities* and with this Specification.

As used in this Specification, the term *structural steel* refers to the steel elements of the structural steel frame essential to the support of the required loads. Such elements are enumerated in Section 2.1 of the *AISC Code of Standard Practice for Steel Buildings and Bridges*. For the design of cold-formed steel structural members, whose profiles contain rounded corners and slender flat elements, the provisions of the American Iron and Steel Institute *Specification for the Design of Cold-Formed Steel Structural Members* are recommended.

### A2. TYPES OF CONSTRUCTION

Two basic types of construction and associated design assumptions shall be permitted under the conditions stated herein, and each will govern in a specific manner the strength of members and the types and strength of their connections.

Type FR (fully restrained), commonly designated as “rigid-frame” (continuous frame), assumes that connections have sufficient stiffness to maintain the angles between intersecting members.

Type PR (partially restrained) assumes that connections have insufficient stiffness to maintain the angles between intersecting members. When connection restraint is considered, use of Type PR construction under this Specification requires that the

strength, stiffness and ductility characteristics of the connections be incorporated in the analysis and design. These characteristics shall be documented in the technical literature or established by analytical or experimental means.

When connection restraint is ignored, commonly designated “simple framing,” it is assumed that for the transmission of gravity loads the ends of the beams and girders are connected for shear only and are free to rotate. For “simple framing” the following requirements apply:

- (1) The connections and connected members shall be adequate to resist the factored gravity loads as “simple beams.”
- (2) The connections and connected members shall be adequate to resist the factored lateral loads.
- (3) The connections shall have sufficient inelastic rotation capacity to avoid overload of fasteners or welds under combined factored gravity and lateral loading.

The type of construction assumed in the design shall be indicated on the design documents. The design of all connections shall be consistent with the assumption.

### **A3. MATERIAL**

#### **1. Structural Steel**

##### **1a. ASTM Designations**

Material conforming to one of the following standard specifications is approved for use under this Specification:

Carbon Structural Steel, ASTM A36/A36M

Pipe, Steel, Black and Hot-Dipped, Zinc-Coated Welded and Seamless ASTM A53/A53M, Gr. B

High-Strength Low-Alloy Structural Steel, ASTM A242/A242M

Cold-Formed Welded and Seamless Carbon Steel Structural Tubing in Rounds and Shapes, ASTM A500

Hot-Formed Welded and Seamless Carbon Steel Structural Tubing, ASTM 501

High-Yield-Strength, Quenched and Tempered Alloy Steel Plate, Suitable for Welding, ASTM A514/A514M

High-Strength Carbon-Manganese Steel of Structural Quality, ASTM A529/A529M

Steel, Sheet and Strip, Carbon, Hot-Rolled, Structural Quality, ASTM A570/A570M, Gr. 40 (275), 45 (310), and 50 (345)

High-Strength Low-Alloy Columbium-Vanadium Steels of Structural Quality, ASTM A572/A572M

High-Strength Low-Alloy Structural Steel with 50 ksi (345 MPa) Minimum Yield Point to 4-in. (100 mm) Thick, ASTM A588/A588M

Steel, Sheet and Strip, High-Strength, Low-Alloy, Hot-Rolled and Cold-Rolled, with Improved Atmospheric Corrosion Resistance, ASTM A606

Steel, Sheet and Strip, High-Strength, Low-Alloy, Columbium or Vanadium, or Both, Hot-Rolled and Cold-Rolled, ASTM A607

Hot-Formed Welded and Seamless High-Strength Low-Alloy Structural Tubing, ASTM A618

Carbon and High-Strength Low-Alloy Structural Steel Shapes, Plates and Bars

and Quenched-and-Tempered Alloy Structural Steel Plates for Bridges, ASTM A709/A709M

Quenched and Tempered Low-Alloy Structural Steel Plate with 70 ksi (485 MPa)

Minimum Yield Strength to 4 in. (100 mm) Thick, ASTM A852/A852M

High-Strength Low-Alloy Steel Shapes of Structural Quality, Produced by Quenching and Self-Tempering Process (QST), ASTM A913/A913M

Steel for Structural Shapes for Use in Building Framing, ASTM A992/A992M

Certified mill test reports or certified reports of tests made by the fabricator or a testing laboratory in accordance with ASTM A6/A6M, Standard Specification for General Requirements for Rolled Structural Steel Bars, Plates, Shapes, and Sheet Piling or A568/A568M, Standard Specification for Steel, Sheet, Carbon, and High-Strength, Low-Alloy, Hot-Rolled and Cold-Rolled, General Requirements for, as applicable, shall constitute sufficient evidence of conformity with one of the above ASTM standards. If requested, the fabricator shall provide an affidavit stating that the structural steel furnished meets the requirements of the grade specified.

### **1b. Unidentified Steel**

Unidentified steel, if surface conditions are acceptable according to criteria contained in ASTM A6/A6M, is permitted to be used for unimportant members or details, where the precise physical properties and weldability of the steel would not affect the strength of the structure.

### **1c. Heavy Shapes**

For ASTM A6/A6M Group 4 and 5 rolled shapes to be used as members subject to primary tensile stresses due to tension or flexure, toughness need not be specified if splices are made by bolting. If such members are spliced using complete-joint-penetration groove welds, the steel shall be specified in the contract documents to be supplied with Charpy V-notch (CVN) impact testing in accordance with ASTM A6/A6M, Supplementary Requirement S5. The impact test shall meet a minimum average value of 20 ft-lbs. (27 J) absorbed energy at +70°F (+21°C) and shall be conducted in accordance with ASTM A673/A673M, with the following exceptions:

- (1) The center longitudinal axis of the specimens shall be located as near as practical to midway between the inner flange surface and the center of the flange thickness at the intersection with the web mid-thickness.
- (2) Tests shall be conducted by the producer on material selected from a location representing the top of each ingot or part of an ingot used to produce the product represented by these tests.

For plates exceeding two-in. (50 mm) thick used for built-up cross-sections with bolted splices and subject to primary tensile stresses due to tension or flexure, material toughness need not be specified. If such cross-sections are spliced using complete-joint-penetration welds, the steel shall be specified in the contract documents to be supplied with Charpy V-notch testing in accordance with ASTM A6/A6M, Supplementary Requirement S5. The impact test shall be conducted by the producer in accordance with ASTM A673/A673M, Frequency P, and shall meet a minimum average value of 20 ft-lbs. (27 J) absorbed energy at +70°F (+21°C).

The above supplementary requirements also apply when complete-joint-penetra-

ion welded joints through the thickness of ASTM A6/A6M Group 4 and 5 shapes and built-up cross sections with thickness exceeding two in. (50 mm) are used in connections subjected to primary tensile stress due to tension or flexure of such members. The requirements need not apply to ASTM A6/A6M Group 4 and 5 shapes and built-up members with thickness exceeding two in. (50 mm) to which members other than ASTM A6/A6M Group 4 and 5 shapes and built-up members are connected by complete-joint- penetration welded joints through the thickness of the thinner material to the face of the heavy material.

Additional requirements for joints in heavy rolled and built-up members are given in Sections J1.5, J1.6, J2.6, J2.8 and M2.2.

## **2. Steel Castings and Forgings**

Cast steel shall conform to one of the following standard specifications:

Steel Castings, Carbon, for General Application, ASTM A27/A27M, Gr. 65-35 (450-240)

Steel Castings, High Strength, for Structural Purposes, ASTM A148/148M Gr. 80-50 (550-345)

Steel forgings shall conform to the following standard specification:

Steel Forgings Carbon and Alloy, for General Industrial Use, ASTM A668/A668M

Certified test reports shall constitute sufficient evidence of conformity with standards.

## **3. Bolts, Washers, and Nuts**

Steel bolts, washers, and nuts shall conform to one of the following standard specifications:

Carbon and Alloy Steel Nuts for Bolts for High-Pressure or High-Temperature Service, or Both, ASTM A194/A194M

Carbon Steel Bolts and Studs, 60,000 PSI Tensile Strength, ASTM A307  
Structural Bolts, Steel, Heat Treated, 120/105 ksi Minimum Tensile Strength, ASTM A325

High-Strength Bolts for Structural Steel Joints [Metric], ASTM A325M  
Quenched and Tempered Steel Bolts and Studs, ASTM A449

Heat-Treated Steel Structural Bolts, 150 ksi Minimum Tensile Strength, ASTM A490

High-Strength Steel Bolts, Classes 10.9 and 10.9.3, for Structural Steel Joints [Metric], ASTM A490M

Carbon and Alloy Steel Nuts, ASTM A563

Carbon and Alloy Steel Nuts [Metric], ASTM A563M

Hardened Steel Washers, ASTM F436

Hardened Steel Washers [Metric], ASTM F436M

Compressible-Washer-Type Direct Tension Indicators for Use with Structural Fasteners, ASTM F959

Compressible-Washer-Type Direct Tension Indicators for Use with Structural Fasteners [Metric], ASTM F959M

“Twist Off” Type Tension Control Structural Bolt/Nut/Washer Assemblies, Steel, Heat Treated, 120/105 ksi Minimum Tensile Strength, ASTM F1852

ASTM A449 bolts are permitted to be used only in connections requiring bolt diameters greater than 1½-in. (38 mm) and shall not be used in slip-critical connections.

Manufacturer's certification shall constitute sufficient evidence of conformity with the standards.

#### **4. Anchor Rods and Threaded Rods**

Anchor rods and threaded rod steel shall conform to one of the following standard specifications:

Carbon Structural Steel, ASTM A36/A36M

Alloy Steel and Stainless Steel Bolting Materials for High-Temperature Service, ASTM A193/A193M

Quenched and Tempered Alloy Steel Bolts, Studs and Other Externally Threaded Fasteners, ASTM A354

High-Strength Low-Alloy Columbium-Vanadium Structural Steel, ASTM A572/A572M

High-Strength Low-Alloy Structural Steel with 50 ksi [345 MPa] Minimum Yield Point to 4-in. [100 mm] Thick, ASTM A588/A588M

Anchor Bolts, Steel, 36, 55, and 105-ksi Yield Strength, ASTM F1554

Threads on anchor rods and threaded rods shall conform to the Unified Standard Series of ASME B18.2.6 and shall have Class 2A tolerances.

Steel bolts conforming to other provisions of Section A3.3 are permitted as anchor rods. A449 material is acceptable for high-strength anchor rods and threaded rods of any diameter.

Manufacturer's certification shall constitute sufficient evidence of conformity with the standards.

#### **5. Filler Metal and Flux for Welding**

Filler metals and fluxes shall conform to one of the following specifications of the American Welding Society:

Specification for Carbon Steel Electrodes for Shielded Metal Arc Welding, AWS A5.1

Specification for Low-Alloy Steel Electrodes for Shielded Metal Arc Welding, AWS A5.5

Specification for Carbon Steel Electrodes and Fluxes for Submerged Arc Welding, AWS A5.17/A5.17M

Specification for Carbon Steel Electrodes and Rods for Gas Shielded Arc Welding, AWS A5.18

Specification for Carbon Steel Electrodes for Flux Cored Arc Welding, AWS A5.20

Specification for Low-Alloy Steel Electrodes and Fluxes for Submerged Arc Welding, AWS A5.23/A5.23M

Specification for Carbon and Low-Alloy Steel Electrodes and Fluxes for Electroslag Welding, AWS A5.25/A5.25M

Specification for Carbon and Low-Alloy Steel Electrodes for Electrode Gas Welding, AWS A5.26/A5.26M

Specification for Low-Alloy Steel Electrodes and Rods for Gas Shielded Arc Welding, AWS A5.28

Specification for Low-Alloy Steel Electrodes for Flux Cored Arc Welding, AWS A5.29

Specification for Welding Shielding Gases, AWS A5.32/A5.32M

Manufacturer's certification shall constitute sufficient evidence of conformity with the standards. Filler metals and fluxes that are suitable for the intended application shall be selected.

## 6. Stud Shear Connectors

Steel stud shear connectors shall conform to the requirements of *Structural Welding Code—Steel*, AWS D1.1.

Manufacturer's certification shall constitute sufficient evidence of conformity with the code.

## A4. LOADS AND LOAD COMBINATIONS

The nominal loads and factored load combinations shall be as stipulated by the applicable code under which the structure is designed or dictated by the conditions involved. In the absence of a code, the loads and factored load combinations, including impact and crane loads, shall be those stipulated in ASCE 7. For design purposes, the loads stipulated by the applicable code or ASCE 7 shall be taken as nominal loads.

## A5. DESIGN BASIS

### 1. Required Strength at Factored Loads

The required strength of structural members and connections shall be determined by structural analysis for the appropriate factored load combinations as stipulated in Section A4.

Design by either elastic or plastic analysis is permitted, except that design by plastic analysis is permitted only for steels with specified minimum yield stresses not exceeding 65 ksi (450 MPa) and is subject to provisions of Sections B5.2, C1.1, C2.1a, C2.2a, E1.2, F1.3, H1, and I1.

Beams and girders composed of compact sections, as defined in Section B5.1, and satisfying the unbraced length requirements of Section F1.3 (including composite members) which are continuous over supports or are rigidly framed to columns may be proportioned for nine-tenths of the negative moments produced by the factored gravity loading at points of support, provided that the maximum positive moment is increased by one-tenth of the average negative moments. This reduction is not permitted for hybrid beams, members of A514/A514M steel, or moments produced by loading on cantilevers. If the negative moment is resisted by a column rigidly framed to the beam or girder, the one-tenth reduction may be used in proportioning the column for combined axial force and flexure, provided that the axial force does not exceed  $\phi_c$  times  $0.15A_gF_y$ ,

where

$A_g$  = gross area, in.<sup>2</sup> (mm<sup>2</sup>)

$F_y$  = specified minimum yield stress, ksi (MPa)

$\phi_c$  = resistance factor for compression

## 2. Limit States

LRFD is a method of proportioning structures so that no applicable limit state is exceeded when the structure is subjected to all appropriate factored load combinations.

Strength limit states are related to safety and concern maximum load carrying capacity. Serviceability limit states are related to performance under normal service conditions. The term “resistance” includes both strength limit states and serviceability limit states.

## 3. Design for Strength

The required strength shall be determined for each applicable load combination as stipulated in Section A4.

The design strength of each structural component or assemblage shall equal or exceed the required strength based on the factored loads. The design strength  $\phi R_n$  for each applicable limit state is calculated as the nominal strength  $R_n$  multiplied by a resistance factor  $\phi$ . Nominal strengths  $R_n$  and resistance factors  $\phi$  are given in Chapters D through K.

## 4. Design for Serviceability and Other Considerations

The overall structure and the individual members, connections, and connectors shall be checked for serviceability. Provisions for design for serviceability are given in Chapter L.

## A6. REFERENCED CODES AND STANDARDS

The following documents are referenced in this Specification:

ACI International (ACI)

*Building Code Requirements for Structural Concrete and Commentary*, ACI 318-99

*Metric Building Code Requirements for Structural Concrete and Commentary*, ACI 318M-99

American Institute of Steel Construction, Inc. (AISC)

*Code of Standard Practice for Steel Buildings and Bridges*, 2000

*Seismic Provisions for Structural Steel Buildings*, 1997

*Seismic Provisions for Structural Steel Buildings Supplement No. 1*, 1999

*Specification for Structural Steel Buildings-Allowable Stress Design and Plastic Design*, 1989

*Specification for Load and Resistance Factor Design of Single-Angle Members*, 1993

*Specification for the Design of Steel Hollow Structural Sections*, 1997

*Specification for the Design, Fabrication and Erection of Steel Safety Related Structures for Nuclear Facilities*, 1994

American Iron and Steel Institute (AISI)

*Specification for the Design of Cold-Formed Steel Structural Members*, 1996

*Specification for the Design of Cold-Formed Steel Structural Members, Supplement No. 1*, 1999



American Society of Civil Engineers (ASCE)

*Minimum Design Loads for Buildings and Other Structures*, ASCE 7-98

American Society of Mechanical Engineers (ASME)

*Fasteners for Use in Structural Applications*, ASME B18.2.6-96

*Surface Texture, Surface Roughness, Waviness, and Lay*, ASME B46.1-85

American Society for Testing and Materials (ASTM)

ASTM A6/A6M-2000

ASTM A27/A27M-95

ASTM A36/A36M-97a

ASTM A53/A53M-99b

ASTM A148/A148M-93b

ASTM A193/A193M-99

ASTM A194/A194M-98b

ASTM A242/A242M-98

ASTM A307-97

ASTM A325-97

ASTM A325M-97

ASTM A354-98

ASTM A370-97a

ASTM A449-93

ASTM A490-97

ASTM A490M-93

ASTM A500-99

ASTM A501-99

ASTM A502-93

ASTM A514/A514M-94a

ASTM A529/A529M-96

ASTM A563-97

ASTM A563M-97

ASTM A568/568M-98

ASTM A570/A570M-98

ASTM A572/A572M-99

ASTM A588/A588M-97a

ASTM A606-98

ASTM A607-96

ASTM A618-99

ASTM A668/A668M-96

ASTM A673/A673M-95

ASTM A709/A709M-97b

ASTM A751-96

ASTM A847-99a

ASTM A852/A852M-97

ASTM A913/A913M-97

ASTM A992/A992M-98

ASTM C33-97

ASTM C330-97

ASTM F436-93

ASTM F436M-93

ASTM F606-98

ASTM F606M-95b

ASTM F959-96

ASTM F959M-97

ASTM F1554-99

ASTM F1852-98

American Welding Society (AWS)

AWS D1.1:2000

AWS A5.25/A5.25M-97

AWS A5.17/A5.17M-98

AWS A5.29-98

AWS A5.23/A5.23M-97

AWS A5.5-96

AWS A5.28-96

AWS A5.20-95

AWS A5.1-91

AWS A5.26/A5.26M-97

AWS A5.18-93

AWS A5.32/A5.32M-97

Research Council on Structural Connections (RCSC)

*Load and Resistance Factor Design Specification for Structural Joints Using  
ASTM A325 or A490 Bolts*, 1994

## A7. DESIGN DOCUMENTS

The design drawings shall show a complete design with sizes, sections, and relative locations of all members. Floor levels, column centers and offsets shall be dimensioned. Drawings shall be drawn to a scale large enough to show the information clearly.

Design documents shall indicate the type or types of construction as defined in Sec-

tion A2 and include the required strengths (moments and forces) if necessary for preparation of shop drawings.

Where joints are to be assembled with high-strength bolts, the design documents shall indicate the connection type (i.e., snug-tightened, pretensioned, or slip-critical).

Camber of trusses, beams, and girders, if required, shall be specified in the design documents.

The requirements for stiffeners and bracing shall be shown in the design documents.

Welding and inspection symbols used on design and shop drawings shall be the American Welding Society symbols. Welding symbols for special requirements not covered by AWS are permitted to be used provided complete explanations thereof are shown in the design documents.

Weld lengths called for in the design documents and on the shop drawings shall be the net effective lengths.

# CHAPTER B

## DESIGN REQUIREMENTS

This chapter contains provisions which are common to the Specification as a whole.

### B1. GROSS AREA

The gross area  $A_g$  of a member at any point is the sum of the products of the thickness and the gross width of each element measured normal to the axis of the member. For angles, the gross width is the sum of the widths of the legs less the thickness.

### B2. NET AREA

The net area  $A_n$  of a member is the sum of the products of the thickness and the net width of each element computed as follows:

In computing net area for tension and shear, the width of a bolt hole shall be taken as  $\frac{1}{16}$ -in. (2 mm) greater than the nominal dimension of the hole.

For a chain of holes extending across a part in any diagonal or zigzag line, the net width of the part shall be obtained by deducting from the gross width the sum of the diameters or slot dimensions as provided in Section J3.2, of all holes in the chain, and adding, for each gage space in the chain, the quantity  $s^2/4g$

where

- $s$  = longitudinal center-to-center spacing (pitch) of any two consecutive holes, in. (mm)
- $g$  = transverse center-to-center spacing (gage) between fastener gage lines, in. (mm)

For angles, the gage for holes in opposite adjacent legs shall be the sum of the gages from the back of the angles less the thickness.

In determining the net area across plug or slot welds, the filler metal shall not be considered as adding to the net area.

### B3. EFFECTIVE AREA OF TENSION MEMBERS

The effective area of tension members shall be determined as follows:

- (1) When tension load is transmitted directly to each of the cross-sectional elements by fasteners or welds, the effective area  $A_e$  is equal to the net area  $A_n$ .
- (2) When the tension load is transmitted by fasteners or welds through some but not all of the cross-sectional elements of the member, the effective area  $A_e$  shall be computed as follows:

- (a) When the tension load is transmitted only by fasteners

$$A_e = A_n U \quad (\text{B3-1})$$

where

 $U$  = reduction coefficient

$$= 1 - (\bar{x} / l) \leq 0.9$$

 $\bar{x}$  = connection eccentricity, in. (mm) $l$  = length of the connection in the direction of loading, in. (mm)

- (b) When the tension load is transmitted only by longitudinal welds to other than a plate member or by longitudinal welds in combination with transverse welds

$$A_e = A_g U \quad (\text{B3-2})$$

where

$$U = 1 - (\bar{x} / l) \leq 0.9$$

 $A_g$  = gross area of member, in.<sup>2</sup> (mm<sup>2</sup>)

- (c) When the tension load is transmitted only by transverse welds

$$A_e = A U \quad (\text{B3-3})$$

where

 $A$  = area of directly connected elements, in.<sup>2</sup> (mm<sup>2</sup>)

$$U = 1.0$$

- (d) When the tension load is transmitted to a plate only by longitudinal welds along both edges at the end of the plate

$$A_e = A_g U \quad (\text{B3-4})$$

where

$$\text{For } l \geq 2w \quad \dots \dots \dots U = 1.00$$

$$\text{For } 2w > l \geq 1.5w \quad \dots \dots \dots U = 0.87$$

$$\text{For } 1.5w > l \geq w \quad \dots \dots \dots U = 0.75$$

where

 $l$  = length of weld, in. (mm) $w$  = plate width (distance between welds), in. (mm)

Larger values of  $U$  are permitted to be used when justified by tests or other rational criteria.

For effective area of connecting elements, see Section J5.2.

## B4. STABILITY

General stability shall be provided for the structure as a whole and for each of its elements.

Consideration shall be given to the significant effects of the loads on the deflected shape of the structure and its individual elements.

## B5. LOCAL BUCKLING

### 1. Classification of Steel Sections

Steel sections are classified as compact, noncompact, or slender-element sections. For a section to qualify as compact, its flanges must be continuously connected to the web or webs and the width-thickness ratios of its compression elements must not exceed the limiting width-thickness ratios  $\lambda_p$  from Table B5.1. If the width-thickness ratio of one or more compression elements exceeds  $\lambda_p$ , but does not exceed  $\lambda_r$ , the section is noncompact. If the width-thickness ratio of any element exceeds  $\lambda_r$  from Table B5.1, the section is referred to as a slender-element compression section.

For unstiffened elements which are supported along only one edge parallel to the direction of the compression force, the width shall be taken as follows:

- (a) For flanges of I-shaped members and tees, the width  $b$  is half the full-flange width,  $b_f$ .
- (b) For legs of angles and flanges of channels and zees, the width  $b$  is the full nominal dimension.
- (c) For plates, the width  $b$  is the distance from the free edge to the first row of fasteners or line of welds.
- (d) For stems of tees,  $d$  is taken as the full nominal depth.

For stiffened elements which are supported along two edges parallel to the direction of the compression force, the width shall be taken as follows:

- (a) For webs of rolled or formed sections,  $h$  is the clear distance between flanges less the fillet or corner radius at each flange;  $h_c$  is twice the distance from the centroid to the inside face of the compression flange less the fillet or corner radius.
- (b) For webs of built-up sections,  $h$  is the distance between adjacent lines of fasteners or the clear distance between flanges when welds are used, and  $h_c$  is twice the distance from the centroid to the nearest line of fasteners at the compression flange or the inside face of the compression flange when welds are used;  $h_p$  is twice the distance from the plastic neutral axis to the nearest line of fasteners at the compression flange or the inside face of the compression flange when welds are used.
- (c) For flange or diaphragm plates in built-up sections, the width  $b$  is the distance between adjacent lines of fasteners or lines of welds.
- (d) For flanges of rectangular hollow structural sections, the width  $b$  is the clear distance between webs less the inside corner radius on each side. If the corner radius is not known, the width may be taken as the total section width minus three times the thickness. The thickness  $t$  shall be taken as the design wall thickness. When the design wall thickness is not known, it is permitted to be taken as 0.93 times the nominal wall thickness.

For tapered flanges of rolled sections, the thickness is the nominal value halfway between the free edge and the corresponding face of the web.

## 2. Design by Plastic Analysis

Design by plastic analysis is permitted, as limited in Section A5.1, when flanges subject to compression involving hinge rotation and all webs have a width-thickness ratio less than or equal to the limiting  $\lambda_p$  from Table B5.1. For circular hollow sections see Footnote d of Table B5.1.

## 3. Slender-Element Compression Sections

For the flexural design of I-shaped sections, channels and rectangular or circular sections with slender flange elements, see Appendix F1. For other shapes in flexure or members in axial compression that have slender compression elements, see Appendix B5.3. For plate girders with slender web elements, see Appendix G.

## B6. BRACING AT SUPPORTS

At points of support for beams, girders and trusses, restraint against rotation about their longitudinal axis shall be provided.

## B7. LIMITING SLENDERNESS RATIOS

For members in which the design is based on compression, the slenderness ratio  $Kl/r$  preferably should not exceed 200.

For members in which the design is based on tension, the slenderness ratio  $l/r$  preferably should not exceed 300. The above limitation does not apply to rods in tension. Members in which the design is dictated by tension loading, but which may be subject to some compression under other load conditions, need not satisfy the compression slenderness limit.

## B8. SIMPLE SPANS

Beams, girders and trusses designed on the basis of simple spans shall have an effective length equal to the distance between centers of gravity of the members to which they deliver their end reactions.

## B9. END RESTRAINT

Beams, girders, and trusses designed on the assumptions of full or partial end restraint, as well as the sections of the members to which they connect, shall have design strengths, as prescribed in Chapters D through K, equal to or exceeding the effect of factored forces and moments except that some inelastic but self-limiting deformation of a part of the connection is permitted.

## B10. PROPORTIONS OF BEAMS AND GIRDERS

When rolled or welded shapes, plate girders and cover-plated beams are proportioned on the basis of flexural strength of the gross section:

(a) If

$$0.75F_u A_{fn} \geq 0.9F_y A_{fg} \quad (\text{B10-1})$$

no deduction shall be made for bolt or rivet holes in either flange,  
where

**TABLE B5.1**  
**Limiting Width-Thickness Ratios for**  
**Compression Elements**

Description of Element		Width Thickness Ratio	Limiting Width-Thickness Ratios	
			$\lambda_p$ (compact)	$\lambda_r$ (noncompact)
Unstiffened Elements	Flanges of I-shaped rolled beams and channels in flexure	$b/t$	$0.38\sqrt{E/F_y}$ [c]	$0.83\sqrt{E/F_L}$ [e]
	Flanges of I-shaped hybrid or welded beams in flexure	$b/t$	$0.38\sqrt{E/F_{yt}}$	$0.95\sqrt{E/(F_L/k_c)}$ [e], [f]
	Flanges projecting from built-up compression members	$b/t$	NA	$0.64\sqrt{E/(F_y/k_c)}$ [f]
	Flanges of I-shaped sections in pure compression, plates projecting from compression elements; outstanding legs of pairs of angles in continuous contact; flanges of channels in pure compression	$b/t$	NA	$0.56\sqrt{E/F_y}$
	Legs of single angle struts; legs of double angle struts with separators; unstiffened elements, i.e., supported along one edge	$b/t$	NA	$0.45\sqrt{E/F_y}$
	Stems of tees	$d/t$	NA	$0.75\sqrt{E/F_y}$

$A_{fg}$  = gross flange area, in.<sup>2</sup> (mm<sup>2</sup>)

$A_{fn}$  = net tension flange area calculated in accordance with the provisions of Sections B1 and B2, in.<sup>2</sup> (mm<sup>2</sup>)

$F_u$  = specified minimum tensile strength, ksi (MPa)

(b) If

$$0.75F_u A_{fn} < 0.9F_y A_{fg} \quad (\text{B10-2})$$

the member flexural properties shall be based on an effective tension flange area  $A_{fe}$

$$A_{fe} = \frac{5}{6} \frac{F_u}{F_y} A_{fn} \quad (\text{B10-3})$$

and the maximum flexural strength shall be based on the elastic section modulus.

Hybrid girders shall be proportioned by the flexural strength of their gross section,

**TABLE B5.1 (cont.)**  
**Limiting Width-Thickness Ratios for**  
**Compression Elements**

Description of Element		Width Thickness Ratio	Limiting Width-Thickness Ratios	
			$\lambda_p$ (compact)	$\lambda_r$ (noncompact)
<b>Stiffened Elements</b>	Flanges of rectangular box and hollow structural sections of uniform thickness subject to bending or compression; flange cover plates and diaphragm plates between lines of fasteners or welds  for uniform compression  for plastic analysis	$b/t$	$1.12\sqrt{E/F_y}$  $0.939\sqrt{E/F_y}$	$1.40\sqrt{E/F_y}$  -
	Unsupported width of cover plates perforated with a succession of access holes [b]	$b/t$	NA	$1.86\sqrt{E/F_y}$
	Webs in flexural compression [a]	$h/t_w$	$3.76\sqrt{E/F_y}$ [c], [g]	$5.70\sqrt{E/F_y}$ [h]
	Webs in combined flexural and axial compression	$h/t_w$	for $P_u/\phi_b P_y \leq 0.125$ [c],[g] $3.76\sqrt{\frac{E}{F_y}\left(1 - \frac{2.75P_u}{\phi_b P_y}\right)}$ for $P_u/\phi_b P_y > 0.125$ [c],[g] $1.12\sqrt{\frac{E}{F_y}\left(2.33 - \frac{P_u}{\phi_b P_y}\right)}$ $\geq 1.49\sqrt{\frac{E}{F_y}}$	[h]  $5.70\sqrt{\frac{E}{F_y}\left(1 - 0.74\frac{P_u}{\phi_b P_y}\right)}$
	All other uniformly compressed stiffened elements, i.e., supported along two edges	$b/t$ $h/t_w$	NA	$1.49\sqrt{E/F_y}$
	Circular hollow sections In axial compression In flexure	$D/t$	NA $0.07E/F_y$	$0.11E/F_y$ $0.31E/F_y$
[a] For hybrid beams, use the yield strength of the flange $F_{yf}$ instead of $F_y$ .		[e] $F_L$ = smaller of $(F_y - F_r)$ or $F_{yw}$ , ksi (MPa) $F_r$ = compressive residual stress in flange = 10 ksi (69 MPa) for rolled shapes = 16.5 ksi (114 MPa) for welded shapes		
[b] Assumes net area of plate at widest hole.		[f] $k_c = \frac{4}{\sqrt{h/t_w}}$ and $0.35 \leq k_c \leq 0.763$		
[c] Assumes an inelastic rotation capacity of 3 radians. For structures in zones of high seismicity, a greater rotation capacity may be required.		[g] For members with unequal flanges, use $h_p$ instead of $h$ when comparing to $\lambda_p$ .		
[d] For plastic design use $0.045E/F_y$ .		[h] For members with unequal flanges, see Appendix B5.1.		



subject to the applicable provisions in Appendix G1, provided they are not required to resist an axial force greater than  $\phi_b$  times  $0.15F_{yf}A_g$ , where  $F_{yf}$  is the specified minimum yield stress of the flange material and  $A_g$  is the gross area. No limit is placed on the web stresses produced by the applied bending moment for which a hybrid girder is designed, except as provided in Section K3 and Appendix K3. To qualify as hybrid girders, the flanges at any given section shall have the same cross-sectional area and be made of the same grade of steel.

Flanges of welded beams or girders may be varied in thickness or width by splicing a series of plates or by the use of cover plates.

The total cross-sectional area of cover plates of bolted or riveted girders shall not exceed 70 percent of the total flange area.

High-strength bolts, rivets, or welds connecting flange to web, or cover plate to flange, shall be proportioned to resist the total horizontal shear resulting from the bending forces on the girder. The longitudinal distribution of these bolts, rivets, or intermittent welds shall be in proportion to the intensity of the shear. However, the longitudinal spacing shall not exceed the maximum permitted for compression or tension members in Section E4 or D2, respectively. Bolts, rivets, or welds connecting flange to web shall also be proportioned to transmit to the web any loads applied directly to the flange, unless provision is made to transmit such loads by direct bearing.

Partial length cover plates shall be extended beyond the theoretical cutoff point and the extended portion shall be attached to the beam or girder by high-strength bolts in a slip-critical connection, rivets, or fillet welds. The attachment shall be adequate, at the applicable design strength given in Sections J2.2, J3.8, or K3 to develop the cover plate's portion of the flexural design strength in the beam or girder at the theoretical cutoff point.

For welded cover plates, the welds connecting the cover plate termination to the beam or girder shall have continuous welds along both edges of the cover plate in the length  $a'$ , defined below, and shall be adequate, at the applicable design strength, to develop the cover plate's portion of the design strength in the beam or girder at the distance  $a'$  from the end of the cover plate.

- (a) When there is a continuous weld equal to or larger than three-fourths of the plate thickness across the end of the plate

$$a' = w \quad (\text{B10-4})$$

where

$w$  = width of cover plate, in. (mm)

- (b) When there is a continuous weld smaller than three-fourths of the plate thickness across the end of the plate

$$a' = 1.5w \quad (\text{B10-5})$$

- (c) When there is no weld across the end of the plate

$$a' = 2w \quad (\text{B10-6})$$

# CHAPTER C

## FRAMES AND OTHER STRUCTURES

This chapter contains general requirements for stability of the structure as a whole.

### C1. SECOND ORDER EFFECTS

Second order ( $P\Delta$ ) effects shall be considered in the design of frames.

#### 1. Design by Plastic Analysis

In structures designed on the basis of plastic analysis, as limited in Section A5.1, the required flexural strength  $M_u$  shall be determined from a second-order plastic analysis that satisfies the requirements of Section C2.

#### 2. Design by Elastic Analysis

In structures designed on the basis of elastic analysis,  $M_u$  for beam-columns, connections, and connected members shall be determined from a second-order elastic analysis or from the following approximate second-order analysis procedure:

$$M_u = B_1 M_{nt} + B_2 M_{lt} \quad (\text{C1-1})$$

where

$M_{nt}$  = required flexural strength in member assuming there is no lateral translation of the frame, kip-in. (N-mm)

$M_{lt}$  = required flexural strength in member as a result of lateral translation of the frame only, kip-in. (N-mm)

$$B_1 = \frac{C_m}{(1 - P_u / P_{e1})} \geq 1 \quad (\text{C1-2})$$

$$P_{e1} = \frac{\pi^2 EI}{(KL)^2}$$

where  $I$  is the moment of inertia in the plane of bending and  $K$  is the effective length factor in the plane of bending determined in accordance with Section C2.1, for the braced frame.

$P_u$  = required axial compressive strength for the member under consideration, kips (N)

$C_m$  = a coefficient based on elastic first-order analysis assuming no lateral translation of the frame whose value shall be taken as follows:

- (a) For compression members not subject to transverse loading between their supports in the plane of bending,

$$C_m = 0.6 - 0.4(M_1 / M_2) \quad (\text{C1-3})$$

where  $M_1/M_2$  is the ratio of the smaller to larger moments at the ends of that portion of the member unbraced in the plane of bending under consideration.  $M_1/M_2$  is positive when the member is bent in reverse curvature, negative when bent in single curvature.

- (b) For compression members subjected to transverse loading between their supports, the value of  $C_m$  shall be determined either by rational analysis or by the use of the following values:

For members whose ends are restrained. . . . .  $C_m = 0.85$

For members whose ends are unrestrained . . . . .  $C_m = 1.00$

$$B_2 = \frac{1}{1 - \Sigma P_u \left( \frac{\Delta_{oh}}{\Sigma HL} \right)} \quad (C1-4)$$

or

$$B_2 = \frac{1}{1 - \left( \frac{\Sigma P_u}{\Sigma P_{e2}} \right)} \quad (C1-5)$$

$\Sigma P_u$  = required axial strength of all columns in a story, kips (N)

$\Delta_{oh}$  = lateral inter-story deflection, in. (mm)

$\Sigma H$  = sum of all story horizontal forces producing  $\Delta_{oh}$ , kips (N)

$L$  = story height, in. (mm)

$$P_{e2} = \frac{\pi^2 EI}{(KL)^2}, \text{ kips (N)}$$

where  $I$  is the moment of inertia in the plane of bending and  $K$  is the effective length factor in the plane of bending determined in accordance with Section C2.2, for the unbraced frame.

## C2. FRAME STABILITY

### 1. Braced Frames

In trusses and frames where lateral stability is provided by diagonal bracing, shear walls, or equivalent means, the effective length factor  $K$  for compression members shall be taken as unity, unless structural analysis shows that a smaller value may be used.

The vertical bracing system for a braced multistory frame shall be determined by structural analysis to be adequate to prevent buckling of the structure and to maintain the lateral stability of the structure, including the overturning effects of drift, under the factored load combinations stipulated in Section A4.

The vertical bracing system for a braced multistory frame may be considered to function together with in-plane shear-resisting exterior and interior walls, floor slabs, and roof decks, which are properly secured to the structural frames. The columns, girders, beams, and diagonal members, when used as the vertical bracing system, may be considered to comprise a vertically cantilevered simply connected truss in the analyses for frame buckling and lateral stability. Axial deformation of

all members in the vertical bracing system shall be included in the lateral stability analysis.

### 1a. Design by Plastic Analysis

In braced frames designed on the basis of plastic analysis, as limited in Section A5.1, the axial force in these members caused by factored gravity plus factored horizontal loads shall not exceed  $0.85\phi_c$  times  $A_gF_y$ .

### 2. Unbraced Frames

In frames where lateral stability depends upon the bending stiffness of rigidly connected beams and columns, the effective length factor  $K$  of compression members shall be determined by structural analysis. The destabilizing effects of gravity loaded columns whose simple connections to the frame do not provide resistance to lateral loads shall be included in the design of the moment-frame columns. Stiffness reduction adjustment due to column inelasticity is permitted.

Analysis of the required strength of unbraced multistory frames shall include the effects of frame instability and column axial deformation under the factored load combinations stipulated in Section A4.

### 2a. Design by Plastic Analysis

In unbraced frames designed on the basis of plastic analysis, as limited in Section A5.1, the axial force in the columns caused by factored gravity plus factored horizontal loads shall not exceed  $0.75\phi_c$  times  $A_gF_y$ .

## C3. STABILITY BRACING

### 1. Scope

These requirements address the minimum brace strength and stiffness necessary to ensure member design strengths based on the unbraced length between braces with an effective length factor  $K$  equal to unity. Bracing is assumed to be perpendicular to the member(s) to be braced; for inclined or diagonal bracing, the brace strength (force or moment) and stiffness (force per unit displacement or moment per unit rotation) must be adjusted for the angle of inclination. The evaluation of the stiffness furnished by a brace shall include its member and geometric properties, as well as the effects of connections and anchoring details.

Two general types of bracing systems are considered, relative and nodal. A relative brace controls the movement of the brace point with respect to adjacent braced points. A nodal brace controls the movement at the braced point without direct interaction with adjacent braced points. The strength and stiffness furnished by the stability bracing shall not be less than the required limits. A second order analysis that includes an initial out-of-plumbness of the structure or out-of-straightness of the member to obtain brace strength and stiffness can be used in lieu of the requirements of this section.

### 2. Frames

In braced frames where lateral stability is provided by diagonal bracing, shear walls, or other equivalent means, the required story or panel bracing shear force is:

$$P_{br} = 0.004\sum P_u \quad (C3-1)$$

The required story or panel shear stiffness is:

$$\beta_{br} = \frac{2\Sigma P_u}{\phi L} \quad (C3-2)$$

where

$$\phi = 0.75$$

$\Sigma P_u$  = summation of the factored column axial loads in the story or panel supported by the bracing, kips (N)

$L$  = story height or panel spacing, in. (mm)

These story stability requirements shall be combined with the lateral forces and drift requirements from other sources, such as wind or seismic loading.

### 3. Columns

An individual column can be braced at intermediate points along its length by relative or nodal bracing systems. It is assumed that nodal braces are equally spaced along the column.

#### (a) *Relative Bracing*

The required brace strength is:

$$P_{br} = 0.004P_u \quad (C3-3)$$

The required brace stiffness is:

$$\beta_{br} = \frac{2P_u}{\phi L_b} \quad (C3-4)$$

where

$$\phi = 0.75$$

$P_u$  = required compressive strength, kips (N)

$L_b$  = distance between braces, in. (mm)

#### (b) *Nodal Bracing*

The required brace strength is:

$$P_{br} = 0.01P_u \quad (C3-5)$$

The required brace stiffness is:

$$\beta_{br} = \frac{8P_u}{\phi L_b} \quad (C3-6)$$

where

$$\phi = 0.75$$

When the actual spacing of braced points is less than  $L_q$ , where  $L_q$  is the maximum unbraced length for the required column force with  $K$  equal to one, then  $L_b$  in Equations C3-4 and C3-6 is permitted to be taken equal to  $L_q$ .

#### 4. Beams

Beam bracing must prevent the relative displacement of the top and bottom flanges, i.e. twist of the section. Lateral stability of beams shall be provided by lateral bracing, torsional bracing, or a combination of the two. In members subjected to double curvature bending, the inflection point shall not be considered a brace point.

##### 4a. Lateral Bracing

Bracing shall be attached near the compression flange, except for a cantilevered member, where an end brace shall be attached near the top (tension) flange. Lateral bracing shall be attached to both flanges at the brace point near the inflection point for beams subjected to double curvature bending along the length to be braced.

###### (a) *Relative Bracing*

The required brace strength is:

$$P_{br} = 0.008M_u C_d / h_o \quad (C3-7)$$

The required brace stiffness is:

$$\beta_{br} = \frac{4M_u C_d}{\phi L_b h_o} \quad (C3-8)$$

where

$$\phi = 0.75$$

$M_u$  = required flexural strength, kip-in. (N-mm)

$h_o$  = distance between flange centroids, in. (mm)

$C_d$  = 1.0 for bending in single curvature; 2.0 for double curvature;  $C_d = 2.0$  only applies to the brace closest to the inflection point.

$L_b$  = distance between braces, in. (mm)

###### (b) *Nodal Bracing*

The required brace strength is:

$$P_{br} = 0.02M_u C_d / h_o \quad (C3-9)$$

The required brace stiffness is:

$$\beta_{br} = \frac{10M_u C_d}{\phi L_b h_o} \quad (C3-10)$$

where

$$\phi = 0.75$$

When the actual spacing of braced points is less than  $L_q$ , the maximum unbraced length for  $M_u$ , then  $L_b$  in Equations C3-8 and C3-10 shall be permitted to be taken equal to  $L_q$ .

##### 4b. Torsional Bracing

Torsional bracing can be nodal or continuous along the beam length. The bracing can be attached at any cross-sectional location and need not be attached near the

compression flange. The connection between a torsional brace and the beam must be able to support the required moment given below.

(a) *Nodal Bracing*

The required bracing moment is:

$$M_{br} = \frac{0.024M_u L}{nC_b L_b} \quad (\text{C3-11})$$

The required cross-frame or diaphragm bracing stiffness is:

$$\beta_{rb} = \frac{\beta_r}{\left(1 - \frac{\beta_r}{\beta_{sec}}\right)} \quad (\text{C3-12})$$

where

$$\beta_r = \frac{2.4LM_u^2}{\phi nEI_y C_b^2} \quad (\text{C3-13})$$

$$\beta_{sec} = \frac{3.3E}{h_o} \left( \frac{1.5h_o t_w^3}{12} + \frac{t_s b_s^3}{12} \right) \quad (\text{C3-14})$$

$\phi = 0.75$

$L$  = span length, in. (mm)

$n$  = number of nodal braced points within the span

$E$  = 29,000 ksi (200 000 MPa)

$I_y$  = out-of-plane moment of inertia, in.<sup>4</sup> (mm<sup>4</sup>)

$C_b$  = is a modification factor defined in Chapter F

$t_w$  = beam web thickness, in. (mm)

$t_s$  = web stiffener thickness, in. (mm)

$b_s$  = stiffener width for one-sided stiffeners (use twice the individual stiffener width for pairs of stiffeners), in. (mm)

$\beta_r$  = brace stiffness excluding web distortion, kip-in/radian (N-mm/radian)

$\beta_{sec}$  = web distortional stiffness, including the effect of web transverse stiffeners, if any, kip-in/radian (N-mm/radian)

If  $\beta_{sec} < \beta_r$ , Equation C3-12 is negative, which indicates that torsional beam bracing will not be effective due to inadequate web distortional stiffness.

When required, the web stiffener shall extend the full depth of the braced member and shall be attached to the flange if the torsional brace is also attached to the flange. Alternatively, it shall be permissible to stop the stiffener short by a distance equal to  $4t_w$  from any beam flange that is not directly attached to the torsional brace. When the actual spacing of braced points is less than  $L_q$ , then  $L_b$  in Equation C3-11 shall be permitted to be taken equal to  $L_q$ .

(b) *Continuous Torsional Bracing*

For continuous bracing, use Equations C3-11, C3-12 and C3-13 with  $L/n$  taken as

1.0; the bracing moment and stiffness are given per unit span length. The distortional stiffness for an unstiffened web is

$$\beta_{\text{sec}} = \frac{3.3Et_w^3}{12h_o} \quad (\text{C3-15})$$



# CHAPTER D

## TENSION MEMBERS

This chapter applies to prismatic members subject to axial tension caused by static forces acting through the centroidal axis. For members subject to combined axial tension and flexure, see Section H1.1. For threaded rods, see Section J3. For block shear rupture strength at end connections of tension members, see Section J4.3. For the design tensile strength of connecting elements, see Section J5.2. For members subject to fatigue, see Section K3.

### D1. DESIGN TENSILE STRENGTH

The design strength of tension members,  $\phi_t P_n$ , shall be the lower value obtained according to the limit states of yielding in the gross section and fracture in the net section.

(a) For yielding in the gross section:

$$\begin{aligned}\phi_t &= 0.90 \\ P_n &= F_y A_g\end{aligned}\tag{D1-1}$$

(b) For fracture in the net section:

$$\begin{aligned}\phi_t &= 0.75 \\ P_n &= F_u A_e\end{aligned}\tag{D1-2}$$

where

- $A_e$  = effective net area, in.<sup>2</sup> (mm<sup>2</sup>)
- $A_g$  = gross area of member, in.<sup>2</sup> (mm<sup>2</sup>)
- $F_y$  = specified minimum yield stress, ksi (MPa)
- $F_u$  = specified minimum tensile strength, ksi (MPa)

When members without holes are fully connected by welds, the effective net section used in Equation D1-2 shall be as defined in Section B3. When holes are present in a member with welded-end connections, or at the welded connection in the case of plug or slot welds, the net section through the holes shall be used in Equation D1-2.

### D2. BUILT-UP MEMBERS

For limitations on the longitudinal spacing of connectors between elements in continuous contact consisting of a plate and a shape or two plates, see Section J3.5.

The longitudinal spacing of connectors between components should preferably limit the slenderness ratio in any component between the connectors to 300.

Either perforated cover plates or tie plates without lacing are permitted to be used on the open sides of built-up tension members. Tie plates shall have a length not less than two-thirds the distance between the lines of welds or fasteners connecting them to the components of the member. The thickness of such tie plates shall not be less than one-fiftieth of the distance between these lines. The longitudinal spacing of intermittent welds or fasteners at tie plates shall not exceed six in. (150 mm). The spacing of tie plates shall be such that the slenderness ratio of any component in the length between tie plates should preferably not exceed 300.

### D3. PIN-CONNECTED MEMBERS AND EYEBARS

#### 1. Pin-Connected Members

##### 1a. Design Strength

The design strength of a pin-connected member,  $\phi P_n$ , shall be the lowest value of the following limit states:

- (a) Tension on the net effective area:

$$\phi = \phi_t = 0.75 \quad (D3-1)$$

$$P_n = 2tb_{eff}F_u$$

- (b) Shear on the effective area:

$$\phi = \phi_{sf} = 0.75 \quad (D3-2)$$

$$P_n = 0.6A_{sf}F_u$$

- (c) For bearing on the projected area of the pin, see Section J8.

- (d) For yielding in the gross section, use Equation D1-1.

where

$$A_{sf} = 2t(a + d / 2), \text{ in.}^2 \text{ (mm}^2\text{)}$$

$a$  = shortest distance from edge of the pin hole to the edge of the member measured parallel to the direction of the force, in. (mm)

$b_{eff} = 2t + 0.63$ , in. ( $= 2t + 16$ , mm) but not more than the actual distance from the edge of the hole to the edge of the part measured in the direction normal to the applied force

$d$  = pin diameter, in. (mm)

$t$  = thickness of plate, in. (mm)

##### 1b. Detailing Requirements

The pin hole shall be located midway between the edges of the member in the direction normal to the applied force. When the pin is expected to provide for relative movement between connected parts while under full load, the diameter of the pin hole shall not be more than  $1/32$ -in. (1 mm) greater than the diameter of the pin.

The width of the plate beyond the pin hole shall not be less than  $2b_{eff} + d$  and the minimum extension,  $a$ , beyond the bearing end of the pin hole, parallel to the axis of the member, shall not be less than  $1.33 \times b_{eff}$ .

The corners beyond the pin hole are permitted to be cut at  $45^\circ$  to the axis of the member, provided the net area beyond the pin hole, on a plane perpendicular to the

cut, is not less than that required beyond the pin hole parallel to the axis of the member.

## **2. Eyebars**

### **2a. Design Strength**

The design strength of eyebars shall be determined in accordance with Section D1, with  $A_g$  taken as the cross-sectional area of the body.

For calculation purposes, the width of the body of the eyebars shall not exceed eight times its thickness.

### **2b. Detailing Requirements**

Eyebars shall be of uniform thickness, without reinforcement at the pin holes, and have circular heads whose periphery is concentric with the pin hole.

The radius of transition between the circular head and the eyebar body shall not be less than the head diameter.

The pin diameter shall not be less than seven-eighths times the eyebar body width, and the pin hole diameter shall not be more than  $\frac{1}{32}$ -in (1 mm) greater than the pin diameter.

For steels having  $F_y$  greater than 70 ksi (485 MPa), the hole diameter shall not exceed five times the plate thickness and the width of the eyebar body shall be reduced accordingly.

A thickness of less than  $\frac{1}{2}$ -in. (13 mm) is permissible only if external nuts are provided to tighten pin plates and filler plates into snug contact. The width from the hole edge to the plate edge perpendicular to the direction of applied load shall be greater than two-thirds and, for the purpose of calculation, not more than three-fourths times the eyebar body width.

## CHAPTER E

### COLUMNS AND OTHER COMPRESSION MEMBERS

This chapter applies to compact and non-compact prismatic members subject to axial compression through the centroidal axis. For members subject to combined axial compression and flexure, see Section H1.2. For members with slender compression elements, see Appendix B5.3. For tapered members, see Appendix F3.

#### E1. EFFECTIVE LENGTH AND SLENDERNESS LIMITATIONS

##### 1. Effective Length

The effective length factor  $K$  shall be determined in accordance with Section C2.

##### 2. Design by Plastic Analysis

Design by plastic analysis, as limited in Section A5.1, is permitted if the column slenderness parameter  $\lambda_c$  does not exceed 1.5 $K$ .

#### E2. DESIGN COMPRESSIVE STRENGTH FOR FLEXURAL BUCKLING

The design strength for flexural buckling of compression members whose elements have width-thickness ratios less than  $\lambda_r$  from Section B5.1 is  $\phi_c P_n$ :

$$\begin{aligned}\phi_c &= 0.85 \\ P_n &= A_g F_{cr}\end{aligned}\tag{E2-1}$$

(a) For  $\lambda_c \leq 1.5$

$$F_{cr} = (0.658^{\lambda_c^2}) F_y\tag{E2-2}$$

(b) For  $\lambda_c > 1.5$

$$F_{cr} = \left[ \frac{0.877}{\lambda_c^2} \right] F_y\tag{E2-3}$$

where

$$\lambda_c = \frac{Kl}{r\pi} \sqrt{\frac{F_y}{E}}\tag{E2-4}$$

$A_g$  = gross area of member, in.<sup>2</sup> (mm<sup>2</sup>)

$F_y$  = specified minimum yield stress, ksi (MPa)

$E$  = modulus of elasticity, ksi (MPa)

$K$  = effective length factor

$l$  = laterally unbraced length of member, in. (mm)

$r$  = governing radius of gyration about the axis of buckling, in. (mm)

For members whose elements do not meet the requirements of Section B5.1, see Appendix B5.3.

### E3. DESIGN COMPRESSIVE STRENGTH FOR FLEXURAL-TORSIONAL BUCKLING

The design strength for flexural-torsional buckling of double-angle and tee-shaped compression members whose elements have width-thickness ratios less than  $\lambda_r$  from Section B5.1 is  $\phi_c P_n$ :

where

$$\phi_c = 0.85$$

$$P_n = A_g F_{crft} \quad (\text{E3-1})$$

$$F_{crft} = \left( \frac{F_{cry} + F_{crz}}{2H} \right) \left[ 1 - \sqrt{1 - \frac{4F_{cry}F_{crz}H}{(F_{cry} + F_{crz})^2}} \right] \quad (\text{E3-2})$$

$$F_{crz} = \frac{GJ}{A\bar{r}_o^2}$$

$\bar{r}_o$  = polar radius of gyration about shear center, in. (mm) (see Equation A-E3-8)

$$H = 1 - \frac{y_o^2}{\bar{r}_o^2}$$

$y_o$  = distance between shear center and centroid, in. (mm)

$F_{cry}$  is determined according to Section E2 for flexural buckling about the y-axis of symmetry for  $\lambda_c = \frac{Kl}{r_y} \pi \sqrt{\frac{F_y}{E}}$ .

For double-angle and tee-shaped members whose elements do not meet the requirements of Section B5.1, see Appendix B5.3 to determine  $F_{cry}$  for use in Equation E3-1.

Other singly symmetric and unsymmetric columns, and doubly symmetric columns, such as cruciform or built-up columns, with very thin walls shall be designed for the limit states of flexural-torsional and torsional buckling in accordance with Appendix E3.

## E4. BUILT-UP MEMBERS

### 1. Design Strength

The design strength of built-up members composed of two or more shapes shall be determined in accordance with Section E2 and Section E3 subject to the following modification. If the buckling mode involves relative deformations that produce shear forces in the connectors between individual shapes,  $Kl/r$  is replaced by  $(Kl/r)_m$  determined as follows:

(a) For intermediate connectors that are snug-tight bolted:

$$\left(\frac{Kl}{r}\right)_m = \sqrt{\left(\frac{Kl}{r}\right)_o^2 + \left(\frac{a}{r_i}\right)^2} \quad (\text{E4-1})$$

(b) For intermediate connectors that are welded or fully tensioned bolted:

$$\left(\frac{Kl}{r}\right)_m = \sqrt{\left(\frac{Kl}{r}\right)_o^2 + 0.82 \frac{\alpha^2}{(1 + \alpha^2)} \left(\frac{a}{r_{ib}}\right)^2} \quad (\text{E4-2})$$

where

$\left(\frac{Kl}{r}\right)_o$  = column slenderness of built-up member acting as a unit

$\left(\frac{Kl}{r}\right)_m$  = modified column slenderness of built-up member

$a$  = distance between connectors, in. (mm)

$r_i$  = minimum radius of gyration of individual component, in. (mm)

$r_{ib}$  = radius of gyration of individual component relative to its centroidal axis parallel to member axis of buckling, in. (mm)

$\alpha$  = separation ratio =  $h / 2r_{ib}$

$h$  = distance between centroids of individual components perpendicular to the member axis of buckling, in. (mm)

## 2. Detailing Requirements

At the ends of built-up compression members bearing on base plates or milled surfaces, all components in contact with one another shall be connected by a weld having a length not less than the maximum width of the member or by bolts spaced longitudinally not more than four diameters apart for a distance equal to  $1\frac{1}{2}$  times the maximum width of the member.

Along the length of built-up compression members between the end connections required above, longitudinal spacing for intermittent welds, bolts, or rivets shall be adequate to provide for the transfer of the required forces. For limitations on the longitudinal spacing of connectors between elements in continuous contact consisting of a plate and a shape or two plates, see Section J3.5. Where a component of a built-up compression member consists of an outside plate, the maximum spacing shall not exceed the thickness of the thinner outside plate times  $0.75\sqrt{E/F_y}$ , nor 12 in. (305 mm), when intermittent welds are provided along the edges of the components or when fasteners are provided on all gage lines at each section. When fasteners are staggered, the maximum spacing on each gage line shall not exceed the thickness of the thinner outside plate times  $1.12\sqrt{E/F_y}$  nor 18 in. (460 mm).

Individual components of compression members composed of two or more shapes shall be connected to one another at intervals,  $a$ , such that the effective slenderness ratio  $Ka / r_i$  of each of the component shapes, between the connectors, does not exceed three-fourths times the governing slenderness ratio of the built-up member. The least radius of gyration  $r_i$  shall be used in computing the slenderness ratio of each component part. The end connection shall be welded or fully tensioned bolted with clean mill scale or blast-cleaned faying surfaces with Class A coatings.

Open sides of compression members built up from plates or shapes shall be provided with continuous cover plates perforated with a succession of access holes. The unsupported width of such plates at access holes, as defined in Section B5.1, is assumed to contribute to the design strength provided that:

- (1) The width-thickness ratio conforms to the limitations of Section B5.1.
- (2) The ratio of length (in direction of stress) to width of hole shall not exceed two.
- (3) The clear distance between holes in the direction of stress shall be not less than the transverse distance between nearest lines of connecting fasteners or welds.
- (4) The periphery of the holes at all points shall have a minimum radius of  $1\frac{1}{2}$ -in. (38 mm).

As an alternative to perforated cover plates, lacing with tie plates is permitted at each end and at intermediate points if the lacing is interrupted. Tie plates shall be as near the ends as practicable. In main members providing design strength, the end tie plates shall have a length of not less than the distance between the lines of fasteners or welds connecting them to the components of the member. Intermediate tie plates shall have a length not less than one-half of this distance. The thickness of tie plates shall be not less than one-fiftieth of the distance between lines of welds or fasteners connecting them to the segments of the members. In welded construction, the welding on each line connecting a tie plate shall aggregate not less than one-third the length of the plate. In bolted and riveted construction, the spacing in the direction of stress in tie plates shall be not more than six diameters and the tie plates shall be connected to each segment by at least three fasteners.

Lacing, including flat bars, angles, channels, or other shapes employed as lacing, shall be so spaced that  $l/r$  of the flange included between their connections shall not exceed the governing slenderness ratio for the member as a whole. Lacing shall be proportioned to provide a shearing strength normal to the axis of the member equal to two percent of the compressive design strength of the member. The  $l/r$  ratio for lacing bars arranged in single systems shall not exceed 140. For double lacing this ratio shall not exceed 200. Double lacing bars shall be joined at the intersections. For lacing bars in compression,  $l$  is permitted to be taken as the unsupported length of the lacing bar between welds or fasteners connecting it to the components of the built-up member for single lacing, and 70 percent of that distance for double lacing. The inclination of lacing bars to the axis of the member shall preferably be not less than  $60^\circ$  for single lacing and  $45^\circ$  for double lacing. When the distance between the lines of welds or fasteners in the flanges is more than 15 in. (380 mm), the lacing shall preferably be double or be made of angles.

For additional spacing requirements, see Section J3.

## **E5. CONNECTIONS FOR PIN-CONNECTED COMPRESSION MEMBERS**

Pin connections of pin-connected compression members shall conform to the requirements of Sections D3.1 and D3.2, except Equations D3-1 and D3-2 do not apply.

# CHAPTER F

## BEAMS AND OTHER FLEXURAL MEMBERS

This chapter applies to compact and noncompact prismatic members subject to flexure and shear. For members subject to combined flexure and axial force, see Section H1. For members subject to fatigue, see Section K3. For members with slender compression elements, see Appendix B5. For web-tapered members, see Appendix F3. For members with slender web elements (plate girders), see Appendix G.

### F1. DESIGN FOR FLEXURE

The nominal flexural strength  $M_n$  is the lowest value obtained according to the limit states of: (a) yielding; (b) lateral-torsional buckling; (c) flange local buckling; and (d) web local buckling. For laterally braced compact beams with  $L_b \leq L_p$ , only the limit state of yielding is applicable. For unbraced compact beams and noncompact tees and double angles, only the limit states of yielding and lateral-torsional buckling are applicable. The lateral-torsional buckling limit state is not applicable to members subject to bending about the minor axis, or to square or circular shapes.

This section applies to homogeneous and hybrid shapes with at least one axis of symmetry and which are subject to simple bending about one principal axis. For simple bending, the beam is loaded in a plane parallel to a principal axis that passes through the shear center or the beam is restrained against twisting at load points and supports. Only the limit states of yielding and lateral-torsional buckling are considered in this section. The lateral-torsional buckling provisions are limited to doubly symmetric shapes, channels, double angles, and tees. For lateral-torsional buckling of other singly symmetric shapes and for the limit states of flange local buckling and web local buckling of noncompact or slender-element sections, see Appendix F1. For unsymmetric shapes and beams subject to torsion combined with flexure, see Section H2. For biaxial bending, see Section H1.

#### 1. Yielding

The flexural design strength of beams, determined by the limit state of yielding, is  $\phi_b M_n$ :

$$\begin{aligned} \phi_b &= 0.90 \\ M_n &= M_p \end{aligned} \tag{F1-1}$$

where

$M_p$  = plastic moment ( $= F_y Z \leq 1.5M_y$  for homogeneous sections), kip-in. (N-mm)  
 $M_y$  = moment corresponding to onset of yielding at the extreme fiber from an elastic stress distribution ( $= F_y S$  for homogeneous section and  $F_y S$  for hybrid sections), kip-in. (N-mm)



See Section B10 for further limitations on  $M_n$  where there are holes in the tension flange.

## 2. Lateral-Torsional Buckling

This limit state is only applicable to members subject to major axis bending. The flexural design strength, determined by the limit state of lateral-torsional buckling, is  $\phi_b M_n$ :

$$\phi_b = 0.90$$

$M_n$  = nominal flexural strength determined as follows

### 2a. Doubly Symmetric Shapes and Channels with $L_b \leq L_r$

The nominal flexural strength is:

$$M_n = C_b \left[ M_p - (M_p - M_r) \left( \frac{L_b - L_p}{L_r - L_p} \right) \right] \leq M_p \quad (\text{F1-2})$$

where

$L_b$  = distance between points braced against lateral displacement of the compression flange, or between points braced to prevent twist of the cross section, in. (mm)

$L_p$  = limiting laterally unbraced length as defined below, in. (mm)

$L_r$  = limiting laterally unbraced length as defined below, in. (mm)

$M_r$  = limiting buckling moment as defined below, kip-in. (N-mm)

In the above equation,  $C_b$  is a modification factor for non-uniform moment diagrams where, when both ends of the beam segment are braced:

$$C_b = \frac{12.5M_{max}}{2.5M_{max} + 3M_A + 4M_B + 3M_C} \quad (\text{F1-3})$$

where

$M_{max}$  = absolute value of maximum moment in the unbraced segment, kip-in. (N-mm)

$M_A$  = absolute value of moment at quarter point of the unbraced segment, kip-in. (N-mm)

$M_B$  = absolute value of moment at centerline of the unbraced beam segment, kip-in. (N-mm)

$M_C$  = absolute value of moment at three-quarter point of the unbraced beam segment, kip-in. (N-mm)

$C_b$  is permitted to be conservatively taken as 1.0 for all cases. Equations F1-4 and F1-6 are conservatively based on  $C_b = 1.0$ . For cantilevers or overhangs where the free end is unbraced,  $C_b = 1.0$ .

The limiting unbraced length,  $L_p$ , shall be determined as follows.

(a) For I-shaped members including hybrid sections and channels:

$$L_p = 1.76r_y \sqrt{\frac{E}{F_{yf}}} \quad (\text{F1-4})$$

(b) For solid rectangular bars and box sections:

$$L_p = \frac{0.13r_y E}{M_p} \sqrt{JA} \quad (\text{F1-5})$$

where

$A$  = cross-sectional area, in.<sup>2</sup> (mm<sup>2</sup>)

$J$  = torsional constant, in.<sup>4</sup> (mm<sup>4</sup>)

The limiting laterally unbraced length  $L_r$  and the corresponding buckling moment  $M_r$  shall be determined as follows.

(a) For doubly symmetric I-shaped members and channels:

$$L_r = \frac{r_y X_1}{F_L} \sqrt{1 + \sqrt{1 + X_2 F_L^2}} \quad (\text{F1-6})$$

$$M_r = F_L S_x \quad (\text{F1-7})$$

where

$$X_1 = \frac{\pi}{S_x} \sqrt{\frac{EGJA}{2}} \quad (\text{F1-8})$$

$$X_2 = 4 \frac{C_w}{I_y} \left( \frac{S_x}{GJ} \right)^2 \quad (\text{F1-9})$$

$S_x$  = section modulus about major axis, in.<sup>3</sup> (mm<sup>3</sup>)

$E$  = modulus of elasticity of steel, 29,000 ksi (200 000 MPa)

$G$  = shear modulus of elasticity of steel, 11,200 ksi (77 200 MPa)

$F_L$  = smaller of  $(F_{yf} - F_r)$  or  $F_{yw}$ , ksi (MPa)

$F_r$  = compressive residual stress in flange; 10 ksi (69 MPa) for rolled shapes, 16.5 ksi (114 MPa) for welded built-up shapes

$F_{yf}$  = yield stress of flange, ksi (MPa)

$F_{yw}$  = yield stress of web, ksi (MPa)

$I_y$  = moment of inertia about y-axis, in.<sup>4</sup> (mm<sup>4</sup>)

$C_w$  = warping constant, in.<sup>6</sup> (mm<sup>6</sup>)

(b) For solid rectangular bars and box sections:

$$L_r = \frac{2r_y E \sqrt{JA}}{M_r} \quad (\text{F1-10})$$

$$M_r = F_{yf} S_x \quad (\text{F1-11})$$

## 2b. Doubly Symmetric Shapes and Channels with $L_b > L_r$

The nominal flexural strength is:

$$M_n = M_{cr} \leq M_p \quad (\text{F1-12})$$

where  $M_{cr}$  is the critical elastic moment, determined as follows.

(a) For doubly symmetric I-shaped members and channels:

$$M_{cr} = C_b \frac{\pi}{L_b} \sqrt{EI_y GJ + \left(\frac{\pi E}{L_b}\right)^2 I_y C_w} \quad (\text{F1-13})$$

$$= \frac{C_b S_x X_1 \sqrt{2}}{L_b / r_y} \sqrt{1 + \frac{X_1^2 X_2}{2(L_b / r_y)^2}}$$

(b) For solid rectangular bars and symmetric box sections:

$$M_{cr} = \frac{57000 C_b \sqrt{JA}}{L_b / r_y} \quad (\text{F1-14})$$

## 2c. Tees and Double Angles

For tees and double-angle beams loaded in the plane of symmetry:

$$M_n = M_{cr} = \frac{\pi \sqrt{EI_y GJ}}{L_b} \left[ B + \sqrt{1 + B^2} \right] \quad (\text{F1-15})$$

where

$$\begin{aligned} M_n &\leq 1.5M_y \text{ for stems in tension} \\ M_n &\leq 1.0M_y \text{ for stems in compression} \\ B &= \pm 2.3(d/L_b) \sqrt{I_y / J} \end{aligned} \quad (\text{F1-16})$$

The plus sign for  $B$  applies when the stem is in tension and the minus sign applies when the stem is in compression. If the tip of the stem is in compression anywhere along the unbraced length, use the negative value of  $B$ .

## 3. Design by Plastic Analysis

Design by plastic analysis, as limited in Section A5.1, is permitted for a compact section member bent about the major axis when the laterally unbraced length  $L_b$  of the compression flange adjacent to plastic hinge locations associated with the failure mechanism does not exceed  $L_{pd}$ , determined as follows.

(a) For doubly symmetric and singly symmetric I-shaped members with the compression flange equal to or larger than the tension flange (including hybrid members) loaded in the plane of the web:

$$L_{pd} = \left[ 0.12 + 0.076 \left( \frac{M_1}{M_2} \right) \right] \left( \frac{E}{F_y} \right) r_y \quad (\text{F1-17})$$

where

$F_y$  = specified minimum yield stress of the compression flange, ksi (MPa)

$M_1$  = smaller moment at end of unbraced length of beam, kip-in. (N-mm)

$M_2$  = larger moment at end of unbraced length of beam, kip-in. (N-mm)

$r_y$  = radius of gyration about minor axis, in. (mm)

$(M_1/M_2)$  is positive when moments cause reverse curvature and negative for single curvature

(b) For solid rectangular bars and symmetric box beams:

$$L_{pd} = \left[ 0.17 + 0.10 \left( \frac{M_1}{M_2} \right) \right] \left( \frac{E}{F_y} \right) r_y \geq 0.10 \left( \frac{E}{F_y} \right) r_y \quad (\text{F1-18})$$

There is no limit on  $L_b$  for members with circular or square cross sections nor for any beam bent about its minor axis.

In the region of the last hinge to form, and in regions not adjacent to a plastic hinge, the flexural design strength shall be determined in accordance with Section F1.2.

## F2. DESIGN FOR SHEAR

This section applies to unstiffened webs of singly or doubly symmetric beams, including hybrid beams, and channels subject to shear in the plane of the web. For the design shear strength of webs with stiffeners, see Appendix F2 or Appendix G3. For shear in the weak direction of the shapes above, pipes, and unsymmetric sections, see Section H2. For web panels subject to high shear, see Section K1.7. For shear strength at connections, see Sections J4 and J5.

### 1. Web Area Determination

The web area  $A_w$  shall be taken as the overall depth  $d$  times the web thickness  $t_w$ .

### 2. Design Shear Strength

The design shear strength of unstiffened webs, with  $h/t_w \leq 260$ , is  $\phi_v V_n$ ,

where

$$\phi_v = 0.90$$

$V_n$  = nominal shear strength defined as follows.

(a) For  $h/t_w \leq 2.45\sqrt{E/F_{yw}}$

$$V_n = 0.6F_{yw} A_w \quad (\text{F2-1})$$

(b) For  $2.45\sqrt{E/F_{yw}} < h/t_w \leq 3.07\sqrt{E/F_{yw}}$

$$V_n = 0.6F_{yw}A_w \left( \frac{2.45\sqrt{E/F_{yw}}}{h/t_w} \right) \quad (\text{F2-2})$$

(c) For  $3.07\sqrt{E/F_{yw}} < h/t_w \leq 260$

$$V_n = A_w \left[ \frac{4.52E}{(h/t_w)^2} \right] \quad (\text{F2-3})$$

The general design shear strength of webs with or without stiffeners is given in Appendix F2.2 and an alternative method utilizing tension field action is given in Appendix G3.

### 3. Transverse Stiffeners

See Appendix F2.3.

### F3. WEB-TAPERED MEMBERS

See Appendix F3.

### F4. BEAMS AND GIRDERS WITH WEB OPENINGS

The effect of all web openings on the design strength of steel and composite beams shall be determined. Adequate reinforcement shall be provided when the required strength exceeds the design strength of the member at the opening.

## CHAPTER G

### PLATE GIRDERS

I-shaped plate girders shall be distinguished from I-shaped beams on the basis of the web slenderness ratio  $h/t_w$ . When this value is greater than  $\lambda_r$ , the provisions of Appendices G1 and G2 shall apply for design flexural strength. For  $h/t_w \leq \lambda_r$ , the provisions of Chapter F or Appendix F shall apply for design flexural strength. For girders with unequal flanges, see Appendix B5.1.

The design shear strength and transverse stiffener design shall be based on either Section F2 (without tension-field action) or Appendix G3 (with tension-field action). For girders with unequal flanges, see Appendix B5.1.

## CHAPTER H

### MEMBERS UNDER COMBINED FORCES AND TORSION

This chapter applies to prismatic members subject to axial force and flexure about one or both axes of symmetry, with or without torsion, and torsion only. For web-tapered members, see Appendix F3.

#### H1. SYMMETRIC MEMBERS SUBJECT TO BENDING AND AXIAL FORCE

##### 1. Doubly and Singly Symmetric Members in Flexure and Tension

The interaction of flexure and tension in symmetric shapes shall be limited by Equations H1-1a and H1-1b.

(a) For  $\frac{P_u}{\phi P_n} \geq 0.2$

$$\frac{P_u}{\phi P_n} + \frac{8}{9} \left( \frac{M_{ux}}{\phi_b M_{nx}} + \frac{M_{uy}}{\phi_b M_{ny}} \right) \leq 1.0 \quad (\text{H1-1a})$$

(b) For  $\frac{P_u}{\phi P_n} < 0.2$

$$\frac{P_u}{2\phi P_n} + \left( \frac{M_{ux}}{\phi_b M_{nx}} + \frac{M_{uy}}{\phi_b M_{ny}} \right) \leq 1.0 \quad (\text{H1-1b})$$

where

$P_u$  = required tensile strength, kips (N)

$P_n$  = nominal tensile strength determined in accordance with Section D1, kips (N)

$M_u$  = required flexural strength determined in accordance with Section C1, kip-in. (N-mm)

$M_n$  = nominal flexural strength determined in accordance with Section F1, kip-in. (N-mm)

$x$  = subscript relating symbol to strong axis bending

$y$  = subscript relating symbol to weak axis bending

$\phi$  =  $\phi_t$  = resistance factor for tension (see Section D1)

$\phi_b$  = resistance factor for flexure = 0.90

A more detailed analysis of the interaction of flexure and tension is permitted in lieu of Equations H1-1a and H1-1b.

## 2. Doubly and Singly Symmetric Members in Flexure and Compression

The interaction of flexure and compression in symmetric shapes shall be limited by Equations H1-1a and H1-1b

where

$P_u$  = required compressive strength, kips (N)

$P_n$  = nominal compressive strength determined in accordance with Section E2, kips (N)

$\phi$  =  $\phi_c$  = resistance factor for compression = 0.85 (see Section E2)

$\phi_b$  = resistance factor for flexure = 0.90

## H2. UNSYMMETRIC MEMBERS AND MEMBERS UNDER TORSION AND COMBINED TORSION, FLEXURE, SHEAR, AND/OR AXIAL FORCE

The design strength,  $\phi F_y$ , of the member shall equal or exceed the required strength expressed in terms of the normal stress  $f_{un}$  or the shear stress  $f_{uv}$ , determined by elastic analysis for the factored loads:

(a) For the limit state of yielding under normal stress:

$$f_{un} \leq \phi F_y \quad (\text{H2-1})$$

$$\phi = 0.90$$

(b) For the limit state of yielding under shear stress:

$$f_{uv} \leq 0.6\phi F_y \quad (\text{H2-2})$$

$$\phi = 0.90$$

(c) For the limit state of buckling:

$$f_{un} \text{ or } f_{uv} \leq \phi_c F_{cr}, \text{ as applicable} \quad (\text{H2-3})$$

$$\phi_c = 0.85$$

Some constrained local yielding is permitted adjacent to areas which remain elastic.

## H3. ALTERNATIVE INTERACTION EQUATIONS FOR MEMBERS UNDER COMBINED STRESS

See Appendix H3.



# CHAPTER I

## COMPOSITE MEMBERS

This chapter applies to composite columns composed of rolled or built-up structural steel shapes, pipe or HSS, and structural concrete acting together and to steel beams supporting a reinforced concrete slab so interconnected that the beams and the slab act together to resist bending. Simple and continuous composite beams with shear connectors and concrete-encased beams, constructed with or without temporary shores, are included.

### II. DESIGN ASSUMPTIONS AND DEFINITIONS

*Force Determination.* In determining forces in members and connections of a structure that includes composite beams, consideration shall be given to the effective sections at the time each increment of load is applied.

*Elastic Analysis.* For an elastic analysis of continuous composite beams without haunched ends, it is permissible to assume that the stiffness of a beam is uniform throughout the beam length. The stiffness is permitted to be computed using the weighted average of the moments of inertia in the positive moment region and the negative moment region.

*Plastic Analysis.* When plastic analysis is used, as limited in Section A5.1, the strength of flexural composite members shall be determined from plastic stress distributions.

*Plastic Stress Distribution for Positive Moment.* If the slab in the positive moment region is connected to the steel beam with shear connectors, a concrete stress of  $0.85f_c'$  is permitted to be assumed uniformly distributed throughout the effective compression zone, where  $f_c'$  is the specified compressive strength of the concrete. Concrete tensile strength shall be neglected. A uniformly distributed steel stress of  $F_y$  shall be assumed throughout the tension zone and throughout the compression zone in the structural steel section. The net tensile force in the steel section shall be equal to the compressive force in the concrete slab.

*Plastic Stress Distribution for Negative Moment.* If the slab in the negative moment region is connected to the steel beam with shear connectors, a tensile stress of  $F_{yr}$  shall be assumed in all adequately developed longitudinal reinforcing bars within the effective width of the concrete slab. Concrete tensile strength shall be neglected. A uniformly distributed steel stress of  $F_y$  shall be assumed throughout the tension zone and throughout the compression zone in the structural steel section. The net compressive force in the steel section shall be equal to the total tensile force in the reinforcing steel.

*Elastic Stress Distribution.* When a determination of elastic stress distribution is required, strains in steel and concrete shall be assumed directly proportional to the distance from the neutral axis. The stress shall equal strain times modulus of elas-

tivity for steel,  $E$ , or modulus of elasticity for concrete,  $E_c$ . Concrete tensile strength shall be neglected. Maximum stress in the steel shall not exceed  $F_y$ . Maximum compressive stress in the concrete shall not exceed  $0.85f'_c$ . In composite hybrid beams, the maximum stress in the steel flange shall not exceed  $F_{yf}$  but the strain in the web may exceed the yield strain; the stress shall be taken as  $F_{yw}$  at such locations.

*Fully Composite Beam.* Shear connectors are provided in sufficient numbers to develop the maximum flexural strength of the composite beam. For elastic stress distribution it shall be assumed that no slip occurs.

*Partially Composite Beam.* The shear strength of shear connectors governs the flexural strength of the partially composite beam. Elastic computations such as those for deflections, fatigue, and vibrations shall include the effect of slip.

*Concrete-Encased Beam.* A beam totally encased in concrete cast integrally with the slab may be assumed to be interconnected to the concrete by natural bond, without additional anchorage, provided that: (1) concrete cover over the beam sides and soffit is at least two in. (50 mm); (2) the top of the beam is at least  $1\frac{1}{2}$ -in. (38 mm) below the top and two in. (50 mm) above the bottom of the slab; and (3) concrete encasement contains adequate mesh or other reinforcing steel to prevent spalling of concrete.

*Composite Column.* A steel column fabricated from rolled or built-up steel shapes and encased in structural concrete or fabricated from steel pipe or HSS and filled with structural concrete.

*Encased Composite Column.* A steel column fabricated from rolled or built-up shapes and encased in structural concrete.

*Filled Composite Column.* Structural steel HSS or pipes that are filled with structural concrete.

## 12. COMPRESSION MEMBERS

### 1. Limitations

To qualify as a composite column, the following limitations shall be met:

- (1) The cross-sectional area of the steel shape, pipe, or HSS shall comprise at least four percent of the total composite cross section.
- (2) Concrete encasement of a steel core shall be reinforced with longitudinal load-carrying bars, longitudinal bars to restrain concrete, and lateral ties. Longitudinal load-carrying bars shall be continuous at framed levels; longitudinal restraining bars may be interrupted at framed levels. The spacing of ties shall be not greater than two-thirds of the least dimension of the composite cross section. The cross-sectional area of the transverse and longitudinal reinforcement shall be at least 0.007 sq. in. per in. (180 mm<sup>2</sup> per m) of bar spacing. The encasement shall provide at least  $1\frac{1}{2}$ -in. (38 mm) of clear cover outside of both transverse and longitudinal reinforcement.
- (3) Concrete shall have a specified compressive strength  $f'_c$  of not less than 3 ksi (21 MPa) nor more than 8 ksi (55 MPa) for normal weight concrete and not less than 4 ksi (28 MPa) for light weight concrete.
- (4) The specified minimum yield stress of structural steel and reinforcing bars

used in calculating the strength of a composite column shall not exceed 60 ksi (415 MPa).

- (5) The minimum wall thickness of structural steel pipe or HSS filled with concrete shall be equal to  $b\sqrt{F_y/3E}$  for each face of width  $b$  in rectangular sections and  $D\sqrt{F_y/8E}$  for circular sections of outside diameter  $D$ .

## 2. Design Strength

The design strength of axially loaded composite columns is  $\phi_c P_n$ ,

where

$$\phi_c = 0.85$$

$P_n$  = nominal axial compressive strength determined from Equations E2-1 through E2-4 with the following modifications:

- (1)  $A_g$  is replaced by  $A_s$ , the gross area of steel shape, pipe, or HSS, in.<sup>2</sup> (mm<sup>2</sup>)
- (2)  $r$  is replaced by  $r_m$ , the radius of gyration of the steel shape, pipe, or HSS except that for steel shapes it shall not be less than 0.3 times the overall thickness of the composite cross section in the plane of buckling, in. (mm)
- (3)  $F_y$  is replaced by  $F_{my}$ , the modified yield stress from Equation I2-1

$$F_{my} = F_y + c_1 F_{yr} (A_r / A_s) + c_2 f'_c (A_c / A_s) \quad (\text{I2-1})$$

- (4)  $E$  is replaced by  $E_m$ , the modified modulus of elasticity from Equation I2-2.

$$E_m = E + c_3 E_c (A_c / A_s) \quad (\text{I2-2})$$

where

$A_c$  = area of concrete, in.<sup>2</sup> (mm<sup>2</sup>)

$A_r$  = area of longitudinal reinforcing bars, in.<sup>2</sup> (mm<sup>2</sup>)

$A_s$  = area of steel, in.<sup>2</sup> (mm<sup>2</sup>)

$E$  = modulus of elasticity of steel, ksi (MPa)

$E_c$  = modulus of elasticity of concrete.  $E_c$  is permitted to be computed from  $E_c = w^{1.5} \sqrt{f'_c}$  (metric:  $E_c = 0.041w^{1.5} \sqrt{f'_c}$ ) where  $w$ , the unit weight of concrete, is expressed in lbs./cu. ft (kg/m<sup>3</sup>) and  $f'_c$  is expressed in ksi (MPa).

$F_y$  = specified minimum yield stress of steel shape, pipe, or HSS, ksi (MPa)

$F_{yr}$  = specified minimum yield stress of longitudinal reinforcing bars, ksi (MPa)

$f'_c$  = specified compressive strength of concrete, ksi (MPa)

$c_1, c_2, c_3$  = numerical coefficients. For concrete-filled pipe and HSS:  $c_1 = 1.0$ ,  $c_2 = 0.85$ , and  $c_3 = 0.4$ ; for concrete-encased shapes  $c_1 = 0.7$ ,  $c_2 = 0.6$ , and  $c_3 = 0.2$

## 3. Columns with Multiple Steel Shapes

If the composite cross section includes two or more steel shapes, the shapes shall be interconnected with lacing, tie plates, or batten plates to prevent buckling of individual shapes before hardening of concrete.

#### 4. Load Transfer

Loads applied to axially loaded encased composite columns shall be transferred between the steel and concrete in accordance with the following requirements:

- (a) When the external force is applied directly to the steel section, shear connectors shall be provided to transfer the force  $V_u'$  as follows:

$$V_u' = V_u(1 - A_s F_y / P_n) \quad (I2-3)$$

where

$V_u$  = force introduced to column, kips (N)

$A_s$  = area of steel section, in.<sup>2</sup> (mm<sup>2</sup>)

$F_y$  = yield strength of the steel section, ksi (MPa)

$P_n$  = nominal compressive strength of the composite column without consideration of slenderness effects, kips (N)

- (b) When the external force is applied directly to the concrete encasement, shear connectors shall be provided to transfer the force  $V_u'$  as follows:

$$V_u' = V_u(A_s F_y / P_n) \quad (I2-4)$$

Shear connectors transferring the force  $V_u'$  shall be distributed along the length of the member. The maximum connector spacing shall be 16 in. (405 mm) and connectors shall be placed on at least two faces of the steel shape in a configuration symmetrical about the steel shape axes.

Where the supporting concrete area in direct bearing is wider than the loaded area on one or more sides and otherwise restrained laterally on the remaining sides, the maximum design strength shall be:

$$\phi_B 1.7f_c' A_B \quad (I2-5)$$

where

$\phi_B = 0.65$

$A_B$  = loaded area, in.<sup>2</sup> (mm<sup>2</sup>)

### 13. FLEXURAL MEMBERS

#### 1. Effective Width

The effective width of the concrete slab is the sum of the effective widths for each side of the beam center-line, each of which shall not exceed:

- (1) one-eighth of the beam span, center-to-center of supports;
- (2) one-half the distance to the center-line of the adjacent beam; or
- (3) the distance to the edge of the slab.

#### 2. Design Strength of Beams with Shear Connectors

The positive design flexural strength  $\phi_b M_n$  shall be determined as follows:

- (a) For  $h/t_w \leq 3.76\sqrt{E/F_{yf}}$ :

$\phi_b = 0.85$ ;  $M_n$  shall be determined from the plastic stress distribution on the composite section.

(b) For  $h/t_w > 3.76\sqrt{E/F_{yf}}$ :

$\phi_b = 0.90$ ;  $M_n$  shall be determined from the superposition of elastic stresses, considering the effects of shoring.

The negative design flexural strength  $\phi_b M_n$  shall be determined for the steel section alone, in accordance with the requirements of Chapter F.

Alternatively, the negative design flexural strength  $\phi_b M_n$  shall be computed with:  $\phi_b = 0.85$  and  $M_n$  determined from the plastic stress distribution on the composite section, provided that:

- (1) Steel beam is an adequately braced compact section, as defined in Section B5.
- (2) Shear connectors connect the slab to the steel beam in the negative moment region.
- (3) Slab reinforcement parallel to the steel beam, within the effective width of the slab, is properly developed.

### 3. Design Strength of Concrete-Encased Beams

The design flexural strength  $\phi_b M_n$  shall be computed with  $\phi_b = 0.90$  and  $M_n$  determined from the superposition of elastic stresses, considering the effects of shoring.

Alternatively, the design flexural strength  $\phi_b M_n$  shall be computed with  $\phi_b = 0.90$  and  $M_n$  determined from the plastic stress distribution on the steel section alone.

If shear connectors are provided and the concrete meets the requirements of Section I2.1(2), the design flexural strength  $\phi_b M_n$  shall be computed based upon the plastic stress distribution on the composite section with  $\phi_b = 0.85$ .

### 4. Strength During Construction

When temporary shores are not used during construction, the steel section alone shall have adequate strength to support all loads applied prior to the concrete attaining 75 percent of its specified strength  $f'_c$ . The design flexural strength of the steel section shall be determined in accordance with the requirements of Section F1.

### 5. Formed Steel Deck

#### 5a. General

The design flexural strength,  $\phi_b M_n$ , of composite construction consisting of concrete slabs on formed steel deck connected to steel beams shall be determined by the applicable portions of Section I3.2, with the following modifications:

- (1) This section is applicable to decks with nominal rib height not greater than three in. (75 mm). The average width of concrete rib or haunch  $w_r$  shall be not less than two in. (50 mm), but shall not be taken in calculations as more than the minimum clear width near the top of the steel deck. See Section I3.5c for additional restrictions.
- (2) The concrete slab shall be connected to the steel beam with welded stud shear connectors  $\frac{3}{4}$ -in. (19 mm) or less in diameter (AWS D1.1). Studs shall be

welded either through the deck or directly to the steel beam. Stud shear connectors, after installation, shall extend not less than 1½-in. (38 mm) above the top of the steel deck.

The slab thickness above the steel deck shall be not less than two in. (50 mm).

### 5b. Deck Ribs Oriented Perpendicular to Steel Beam

Concrete below the top of the steel deck shall be neglected in determining section properties and in calculating  $A_c$  for deck ribs oriented perpendicular to the steel beams.

The spacing of stud shear connectors along the length of a supporting beam shall not exceed 36 in. (915 mm).

The nominal strength of a stud shear connector shall be the value stipulated in Section I5 multiplied by the following reduction factor:

$$\frac{0.85}{\sqrt{N_r}}(w_r / h_r)[(H_s / h_r) - 1.0] \leq 1.0 \quad (I3-1)$$

where

$h_r$  = nominal rib height, in. (mm)

$H_s$  = length of stud connector after welding, in. (mm), not to exceed the value  $h_r + 3$  in. (75 mm) in computations, although actual length may be greater

$N_r$  = number of stud connectors in one rib at a beam intersection, not to exceed three in computations, although more than three studs may be installed

$w_r$  = average width of concrete rib or haunch (as defined in Section I3.5a), in. (mm)

Where there is only a single stud placed in a rib oriented perpendicular to the steel beam, the reduction factor of Equation I3-1 shall not exceed 0.75.

To resist uplift, steel deck shall be anchored to all supporting members at a spacing not to exceed 18 in. (460 mm). Such anchorage shall be provided by stud connectors, a combination of stud connectors and arc spot (puddle) welds, or other devices specified by the designer.

### 5c. Deck Ribs Oriented Parallel to Steel Beam

Concrete below the top of the steel deck may be included in determining section properties and shall be included in calculating  $A_c$  in Section I5.

Steel deck ribs over supporting beams may be split longitudinally and separated to form a concrete haunch.

When the nominal depth of steel deck is 1½-in. (38 mm) or greater, the average width  $w_r$  of the supported haunch or rib shall be not less than two in. (50 mm) for the first stud in the transverse row plus four stud diameters for each additional stud.

The nominal strength of a stud shear connector shall be the value stipulated in Section I5, except that when  $w_r / h_r$  is less than 1.5, the value from Section I5 shall be multiplied by the following reduction factor:

$$0.6(w_r / h_r)[(H_s / h_r) - 1.0] \leq 1.0 \quad (I3-2)$$

where  $h_r$  and  $H_s$  are as defined in Section I3.5b and  $w_r$  is the average width of concrete rib or haunch as defined in Section I3.5a.

## 6. Design Shear Strength

The design shear strength of composite beams shall be determined by the shear strength of the steel web, in accordance with Section F2.

## I4. COMBINED COMPRESSION AND FLEXURE

The interaction of axial compression and flexure in the plane of symmetry on composite members shall be limited by Section H1.2 with the following modifications:

- $M_n$  = nominal flexural strength determined from plastic stress distribution on the composite cross section except as provided below, kip-in. (N-mm)
- $P_{e1}, P_{e2} = A_s F_{my} / \lambda_c^2$  elastic buckling load, kips (N)
- $F_{my}$  = modified yield stress, ksi (MPa), see Section I2
- $\phi_b$  = resistance factor for flexure from Section I3
- $\phi_c$  = resistance factor for compression = 0.85
- $\lambda_c$  = column slenderness parameter defined by Equation E2-4 as modified in Section I2.2

When the axial term in Equations H1-1a and H1-1b is less than 0.3, the nominal flexural strength  $M_n$  shall be determined by straight line transition between the nominal flexural strength determined from the plastic distribution on the composite cross sections at  $(P_u / \phi_c P_n) = 0.3$  and the flexural strength at  $P_u = 0$  as determined in Section I3. If shear connectors are used at  $P_u = 0$ , they shall be provided whenever  $P_u / \phi_c P_n$  is less than 0.3.

## I5. SHEAR CONNECTORS

This section applies to the design of stud and channel shear connectors. For connectors of other types, see Section I6.

### 1. Materials

Shear connectors shall be headed steel studs not less than four stud diameters in length after installation, or hot rolled steel channels. The stud connectors shall conform to the requirements of Section A3.6. The channel connectors shall conform to the requirements of Section A3. Shear connectors shall be embedded in concrete slabs made with ASTM C33 aggregate or with rotary kiln produced aggregates conforming to ASTM C330, with concrete unit weight not less than 90 pcf (1 440 kg/m<sup>3</sup>).

### 2. Horizontal Shear Force

The entire horizontal shear at the interface between the steel beam and the concrete slab shall be assumed to be transferred by shear connectors, except for concrete-encased beams as defined in Section I1. For composite action with concrete subject to flexural compression, the total horizontal shear force between the point of maximum positive moment and the point of zero moment shall be taken as the smallest of the following: (a)  $0.85f_c' A_c$ ; (b)  $A_s F_y$ ; and (c)  $\Sigma Q_n$ ;

where

$A_c$  = area of concrete slab within effective width, in.<sup>2</sup> (mm<sup>2</sup>)

$A_s$  = area of steel cross section, in.<sup>2</sup> (mm<sup>2</sup>)

$\Sigma Q_n$  = sum of nominal strengths of shear connectors between the point of maximum positive moment and the point of zero moment, kips (N)

For hybrid beams, the yield force shall be computed separately for each component of the cross section;  $A_s F_y$  of the entire cross section is the sum of the component yield forces.

In continuous composite beams where longitudinal reinforcing steel in the negative moment regions is considered to act compositely with the steel beam, the total horizontal shear force between the point of maximum negative moment and the point of zero moment shall be taken as the smaller of  $A_r F_{yr}$  and  $\Sigma Q_n$ ;

where

$A_r$  = area of adequately developed longitudinal reinforcing steel within the effective width of the concrete slab, in.<sup>2</sup> (mm<sup>2</sup>)

$F_{yr}$  = minimum specified yield stress of the reinforcing steel, ksi (MPa)

### 3. Strength of Stud Shear Connectors

The nominal strength of one stud shear connector embedded in a solid concrete slab is

$$Q_n = 0.5A_{sc} \sqrt{f'_c E_c} \leq A_{sc} F_u \quad (15-1)$$

where

$A_{sc}$  = cross-sectional area of stud shear connector, in.<sup>2</sup> (mm<sup>2</sup>)

$F_u$  = specified minimum tensile strength of a stud shear connector, ksi (MPa)

$E_c$  = modulus of elasticity of concrete, ksi (MPa)

For a stud shear connector embedded in a slab on a formed steel deck, refer to Section I3 for reduction factors given by Equations I3-1 and I3-2 as applicable. The reduction factors apply only to the  $0.5A_{sc} \sqrt{f'_c E_c}$  term in Equation I5-1.

### 4. Strength of Channel Shear Connectors

The nominal strength of one channel shear connector embedded in a solid concrete slab is

$$Q_n = 0.3(t_f + 0.5t_w)L_c \sqrt{f'_c E_c} \quad (15-2)$$

where

$t_f$  = flange thickness of channel shear connector, in. (mm)

$t_w$  = web thickness of channel shear connector, in. (mm)

$L_c$  = length of channel shear connector, in. (mm)

### 5. Required Number of Shear Connectors

The number of shear connectors required between the section of maximum bending moment, positive or negative, and the adjacent section of zero moment shall be equal to the horizontal shear force as determined in Section I5.2 divided by the



nominal strength of one shear connector as determined from Section I5.3 or Section I5.4.

## **6. Shear Connector Placement and Spacing**

Shear connectors required on each side of the point of maximum bending moment, positive or negative, shall be distributed uniformly between that point and the adjacent points of zero moment, unless otherwise specified. However, the number of shear connectors placed between any concentrated load and the nearest point of zero moment shall be sufficient to develop the maximum moment required at the concentrated load point.

Shear connectors shall have at least one in. (25 mm) of lateral concrete cover, except for connectors installed in the ribs of formed steel decks. The diameter of studs shall not be greater than 2.5 times the thickness of the flange to which they are welded, unless located over the web. The minimum center-to-center spacing of stud connectors shall be six diameters along the longitudinal axis of the supporting composite beam and four diameters transverse to the longitudinal axis of the supporting composite beam, except that within the ribs of formed steel decks oriented perpendicular to the steel beam the minimum center-to-center spacing shall be four diameters in any direction. The maximum center-to-center spacing of shear connectors shall not exceed eight times the total slab thickness. Also see Section I3.5b.

## **I6. SPECIAL CASES**

When composite construction does not conform to the requirements of Section I1 through Section I5, the strength of shear connectors and details of construction shall be established by a suitable test program.

# CHAPTER J

## CONNECTIONS, JOINTS, AND FASTENERS

This chapter applies to connecting elements, connectors, and the affected elements of the connected members subject to static loads. For connections subject to fatigue, see Appendix K3.

### J1. GENERAL PROVISIONS

#### 1. Design Basis

Connections consist of affected elements of connected members (e.g., beam webs), connecting elements (e.g., gussets, angles, brackets), and connectors (e.g., welds, bolts, rivets). These components shall be proportioned so that their design strength equals or exceeds the required strength determined by structural analysis for factored loads acting on the structure or a specified proportion of the strength of the connected members, whichever is appropriate.

#### 2. Simple Connections

Connections of beams, girders, or trusses shall be designed as flexible and are permitted to be proportioned for the reaction shears only, except as otherwise indicated in the design documents. Flexible beam connections shall accommodate end rotations of unrestrained (simple) beams. To accomplish this, some inelastic but self-limiting deformation in the connection is permitted.

#### 3. Moment Connections

End connections of restrained beams, girders, and trusses shall be designed for the combined effect of forces resulting from moment and shear induced by the rigidity of the connections.

#### 4. Compression Members with Bearing Joints

When columns bear on bearing plates or are finished to bear at splices, there shall be sufficient connectors to hold all parts securely in place.

When compression members other than columns are finished to bear, the splice material and its connectors shall be arranged to hold all parts in line and shall be proportioned for 50 percent of the required strength of the member.

All compression joints shall be proportioned to resist any tension developed by the factored load combinations stipulated in Section A4.

#### 5. Splices in Heavy Sections

This paragraph applies to ASTM A6/A6M Group 4 and 5 rolled shapes, or shapes built-up by welding plates more than two in. (50 mm) thick together to form the cross section, and where the cross section is to be spliced and subject to primary

tensile stresses due to tension or flexure. When the individual elements of the cross section are spliced prior to being joined to form the cross section in accordance with AWS D1.1, Article 5.21.6, the applicable provisions of AWS D1.1 apply in lieu of the requirements of this section. When tensile forces in these sections are to be transmitted through splices by complete-joint-penetration groove welds, material notch-toughness requirements as given in Section A3.1c, weld access hole details as given in Section J1.6, welding preheat requirements as given in Section J2.8, and thermal-cut surface preparation and inspection requirements as given in Section M2.2 apply.

At tension splices in ASTM A6/A6M Group 4 and 5 shapes and built-up members of material more than two in. (50 mm) thick, weld tabs and backing shall be removed and the surfaces ground smooth.

When splicing ASTM A6/A6M Group 4 and 5 rolled shapes or shapes built-up by welding plates more than two in. (50 mm) thick to form a cross section, and where the section is to be used as a primary compression member, all weld access holes required to facilitate groove welding operations shall satisfy the provisions of Section J1.6.

Alternatively, splicing of such members subject to compression, including members which are subject to tension due to wind or seismic loads, shall be accomplished using splice details which do not induce large weld shrinkage strains; for example partial-joint-penetration flange groove welds with fillet-welded surface lap plate splices on the web, bolted lap plate splices, or combination bolted/fillet-welded lap plate splices.

## **6. Beam Copes and Weld Access Holes**

All weld access holes required to facilitate welding operations shall have a length from the toe of the weld preparation not less than  $1\frac{1}{2}$  times the thickness of the material in which the hole is made. The height of the access hole shall be adequate for deposition of sound weld metal in the adjacent plates and provide clearance for weld tabs for the weld in the material in which the hole is made, but not less than the thickness of the material. In hot-rolled shapes and built-up shapes, all beam copes and weld access holes shall be shaped free of notches and sharp re-entrant corners, except that when fillet web-to-flange welds are used in built-up shapes, access holes are permitted to terminate perpendicular to the flange.

For ASTM A6/A6M Group 4 and 5 shapes and built-up shapes of material more than two in. (50 mm) thick, the thermally cut surfaces of beam copes and weld access holes shall be ground to bright metal and inspected by either magnetic particle or dye penetrant methods prior to deposition of splice welds. If the curved transition portion of weld access holes and beam copes are formed by predrilled or sawed holes, that portion of the access hole or cope need not be ground. Weld access holes and beam copes in other shapes need not be ground nor inspected by dye penetrant or magnetic particle methods.

## **7. Minimum Strength of Connections**

Connections providing design strength shall be designed to support a factored load not less than 10 kips (44 kN), except for lacing, sag rods, or girts.

## 8. Placement of Welds and Bolts

Groups of welds or bolts at the ends of any member which transmit axial force into that member shall be sized so that the center of gravity of the group coincides with the center of gravity of the member, unless provision is made for the eccentricity. The foregoing provision is not applicable to end connections of statically-loaded single angle, double angle, and similar members.

## 9. Bolts in Combination with Welds

In new work, A307 bolts or high-strength bolts proportioned as bearing-type connections shall not be considered as sharing the load in combination with welds. Welds, if used, shall be proportioned for the entire force in the connection. In slip-critical connections, high-strength bolts are permitted to be considered as sharing the load with the welds. These calculations shall be made at factored loads.

In making welded alterations to structures, existing rivets and high-strength bolts tightened to the requirements for slip-critical connections are permitted to be utilized for carrying loads present at the time of alteration and the welding need only provide the additional design strength required.

## 10. High-Strength Bolts in Combination with Rivets

In both new work and alterations, in connections designed as slip-critical connections in accordance with the provisions of Section J3, high-strength bolts are permitted to be considered as sharing the load with rivets.

## 11. Limitations on Bolted and Welded Connections

Fully pretensioned high-strength bolts (see Table J3.1 or J3.1M) or welds shall be used for the following connections:

Column splices in all tier structures 200 ft (60 m) or more in height.

Column splices in tier structures 100 (30 m) to 200 ft (60 m) in height, if the least horizontal dimension is less than 40 percent of the height.

Column splices in tier structures less than 100 ft (30 m) in height, if the least horizontal dimension is less than 25 percent of the height.

Connections of all beams and girders to columns and of any other beams and girders on which the bracing of columns is dependent, in structures over 125 ft (38 m) in height.

In all structures carrying cranes of over five-ton (50 kN) capacity: roof-truss splices and connections of trusses to columns, column splices, column bracing, knee braces, and crane supports.

Connections for supports of running machinery, or of other live loads which produce impact or reversal of stress.

Any other connections stipulated on the design drawings.

In all other cases connections are permitted to be made with A307 bolts or snug-tight high-strength bolts.

For the purpose of this section, the height of a tier structure shall be taken as the vertical distance from the curb level to the highest point of the roof beams in the case of flat roofs, or to the mean height of the gable in the case of roofs having a slope of more than 25 percent. Where the curb level has not been established, or where the structure does not adjoin a street, the mean level of the adjoining land

shall be used instead of curb level. It is permissible to exclude penthouses in computing the height of the structure.

## **J2. WELDS**

All provisions of AWS D1.1, apply under this specification, except the provisions applicable to Tubular Structures, which are outside the scope of this specification, and except that the provisions of the listed AISC LRFD Specification Sections apply under this Specification in lieu of the cited AWS Code provisions as follows:

- AISC Specification Section J1.5 and J1.6 in lieu of AWS D1.1 Section 5.17
- AISC Specification Section J2.2 in lieu of AWS D1.1 Section 2.4.1.1
- AISC Specification Table J2.5 in lieu of AWS D1.1 Table 2.3
- AISC Specification Table A-K3.1 in lieu of AWS D1.1 Section 2.27.1
- AISC Specification Section K3 and Appendix K3 in lieu of AWS Section 2, Part C
- AISC Specification Section M2.2 in lieu of AWS Sections 5.15.1.2, 5.15.4.3 and 5.15.4.4

The length and disposition of welds, including end returns shall be indicated on the design and shop drawings.

### **1. Groove Welds**

#### **1a. Effective Area**

The effective area of groove welds shall be considered as the effective length of the welds times the effective throat thickness.

The effective length of a groove weld shall be the width of the part joined.

The effective throat thickness of a complete-joint-penetration groove weld shall be the thickness of the thinner part joined.

The effective throat thickness of a partial-joint-penetration groove weld shall be as shown in Table J2.1.

The effective throat thickness of a flare groove weld when flush to the surface of a bar or 90° bend in formed section shall be as shown in Table J2.2. Random sections of production welds for each welding procedure, or such test sections as may be required by design documents, shall be used to verify that the effective throat is consistently obtained.

Larger effective throat thicknesses than those in Table J2.2 are permitted, provided the fabricator can establish by qualification the consistent production of such larger effective throat thicknesses. Qualification shall consist of sectioning the weld normal to its axis, at mid-length and terminal ends. Such sectioning shall be made on a number of combinations of material sizes representative of the range to be used in the fabrication or as required by the designer.

#### **1b. Limitations**

The minimum effective throat thickness of a partial-joint-penetration groove weld shall be as shown in Table J2.3. Weld size is determined by the thicker of the two parts joined, except that the weld size need not exceed the thickness of the thinnest part joined, even when a larger size is required by calculated strength. For this

**TABLE J2.1**  
**Effective Throat Thickness of**  
**Partial-Joint-Penetration Groove Welds**

Welding Process	Welding Position	Included Angle at Root of Groove	Effective Throat Thickness
Shielded metal arc Submerged arc	All	J or U joint	Depth of chamfer
Gas metal arc		Bevel or V joint $\geq 60^\circ$	
Flux-cored arc		Bevel or V joint $< 60^\circ$ but $\geq 45^\circ$	Depth of chamfer Minus $\frac{1}{8}$ -in. (3 mm)

**TABLE J2.2**  
**Effective Throat Thickness of Flare Groove Welds**

Type of Weld	Radius (R) of Bar or Bend	Effective Throat Thickness
Flare bevel groove	All	$\frac{5}{16}R$
Flare V-groove	All	$\frac{1}{2}R$

[a] Use  $\frac{3}{8}R$  for Gas Metal Arc Welding (except short circuiting transfer process) when  $R \geq 1$  in. (25 mm)

**TABLE J2.3**  
**Minimum Effective Throat Thickness of**  
**Partial-Joint-Penetration Groove Welds**

Material Thickness of Thicker Part Joined, in. (mm)	Minimum Effective Throat Thickness [a], in. (mm)
To $\frac{1}{4}$ (6) inclusive	$\frac{1}{8}$ (3)
Over $\frac{1}{4}$ (6) to $\frac{1}{2}$ (13)	$\frac{3}{16}$ (5)
Over $\frac{1}{2}$ (13) to $\frac{3}{4}$ (19)	$\frac{1}{4}$ (6)
Over $\frac{3}{4}$ (19) to $1\frac{1}{2}$ (38)	$\frac{5}{16}$ (8)
Over $1\frac{1}{2}$ (38) to $2\frac{1}{4}$ (57)	$\frac{3}{8}$ (10)
Over $2\frac{1}{4}$ (57) to 6 (150)	$\frac{1}{2}$ (13)
Over 6 (150)	$\frac{5}{8}$ (16)

[a] See Table J2.1

exception, particular care shall be taken to provide sufficient preheat for soundness of the weld.

## 2. Fillet Welds

### 2a. Effective Area

The effective area of fillet welds shall be as defined in AWS D1.1 Section 2.4.3 and 2.11. The effective throat thickness of a fillet weld shall be the shortest distance from the root of the joint to the face of the diagrammatic weld, except that for fillet welds made by the submerged arc process, the effective throat thickness shall be

<b>TABLE J2.4 Minimum Size of Fillet Welds</b>	
<b>Material Thickness of Thicker Part Joined, in. (mm)</b>	<b>Minimum Size of Fillet Weld[a] in. (mm)</b>
To $\frac{1}{4}$ (6) inclusive	$\frac{1}{8}$ (3)
Over $\frac{1}{4}$ (6) to $\frac{1}{2}$ (13)	$\frac{3}{16}$ (5)
Over $\frac{1}{2}$ (13) to $\frac{3}{4}$ (19)	$\frac{1}{4}$ (6)
Over $\frac{3}{4}$ (19)	$\frac{5}{16}$ (8)
[a] Leg dimension of fillet welds. Single pass welds must be used.	
[b] See Section J2.2b for maximum size of fillet welds.	

taken equal to the leg size for  $\frac{3}{8}$ -in. (10 mm) and smaller fillet welds, and equal to the theoretical throat plus 0.11-in. (3 mm) for fillet welds over  $\frac{3}{8}$ -in.(10 mm).

For fillet welds in holes and slots, the effective length shall be the length of the centerline of the weld along the center of the plane through the throat. In the case of overlapping fillets, the effective area shall not exceed the nominal cross-sectional area of the hole or slot, in the plane of the faying surface.

## 2b. Limitations

The *minimum size of fillet welds* shall be not less than the size required to transmit calculated forces nor the size as shown in Table J2.4 which is based upon experiences and provides some margin for uncalculated stress encountered during fabrication, handling, transportation, and erection. These provisions do not apply to fillet weld reinforcements of partial- or complete-joint-penetration welds.

The *maximum size of fillet welds* of connected parts shall be:

- (a) Along edges of material less than  $\frac{1}{4}$ -in. (6 mm) thick, not greater than the thickness of the material.
- (b) Along edges of material  $\frac{1}{4}$ -in. (6 mm) or more in thickness, not greater than the thickness of the material minus  $\frac{1}{16}$ -in. (2 mm), unless the weld is especially designated on the drawings to be built out to obtain full-throat thickness. In the as-welded condition, the distance between the edge of the base metal and the toe of the weld is permitted to be less than  $\frac{1}{16}$ -in. (2 mm) provided the weld size is clearly verifiable.

For flange-web welds and similar connections, the actual weld size need not be larger than that required to develop the web capacity, and the requirements of Table J2.4 need not apply.

The *minimum effective length of fillet welds* designed on the basis of strength shall be not less than four times the nominal size, or else the size of the weld shall be considered not to exceed  $\frac{1}{4}$  of its effective length. If longitudinal fillet welds are used alone in end connections of flat-bar tension members, the length of each fillet weld shall be not less than the perpendicular distance between them. For the effect of longitudinal fillet weld length in end connections upon the effective area of the connected member, see Section B3.

For end-loaded fillet welds with a length up to 100 times the leg dimension, it is permitted to take the effective length equal to the actual length. When the length of the end-loaded fillet weld exceeds 100 times the weld size, the effective length shall be determined by multiplying the actual length by the reduction factor,  $\beta$ ,

where

$$\beta = 1.2 - 0.002(L/w) \leq 1.0 \quad (\text{J2-1})$$

$L$  = actual length of end-loaded weld, in. (mm)

$w$  = weld leg size, in. (mm)

When the length of the weld exceeds 300 times the leg size, the value of  $\beta$  shall be taken as 0.60.

*Intermittent fillet welds* may be used to transfer calculated stress across a joint or faying surfaces when the strength required is less than that developed by a continuous fillet weld of the smallest permitted size, and to join components of built-up members. The effective length of any segment of intermittent fillet welding shall be not less than four times the weld size, with a minimum of  $1\frac{1}{2}$ -in. (38 mm).

*In lap joints*, the minimum amount of lap shall be five times the thickness of the thinner part joined, but not less than one in. (25 mm). Lap joints joining plates or bars subjected to axial stress that utilize transverse fillet welds only shall be fillet welded along the end of both lapped parts, except where the deflection of the lapped parts is sufficiently restrained to prevent opening of the joint under maximum loading.

*Fillet weld terminations* are permitted to extend to the ends or sides of parts or be stopped short or boxed except as limited by the following:

- (1) For lap joints in which one part extends beyond an edge subject to calculated tensile stress, fillet welds shall terminate not less than the size of the weld from that edge.
- (2) For connections and structural elements with cyclic forces, normal to outstanding legs, of frequency and magnitude that would tend to cause a progressive fatigue failure initiating from a point of maximum stress at the end of the weld, fillet welds shall be returned around the corner for a distance not less than the smaller of two times the weld size or the width of the part.
- (3) For connections whose design requires flexibility of the outstanding legs, if end returns are used, their length shall not exceed four times the nominal size of the weld.
- (4) Fillet welds joining transverse stiffeners to plate girder webs shall end not less than four times nor more than six times the thickness of the web from the web toe of the web-to-flange welds, except where the ends of stiffeners are welded to the flange.
- (5) Fillet welds, which occur on opposite sides of a common plane, shall be interrupted at the corner common to both welds.

*Fillet welds in holes or slots* may be used to transmit shear in lap joints or to prevent the buckling or separation of lapped parts and to join components of built-up



members. Such fillet welds may overlap, subject to the provisions of Section J2. Fillet welds in holes or slots are not to be considered plug or slot welds.

### 3. Plug and Slot Welds

#### 3a. Effective Area

The effective shearing area of plug and slot welds shall be considered as the nominal cross-sectional area of the hole or slot in the plane of the faying surface.

#### 3b. Limitations

Plug or slot welds are permitted to be used to transmit shear in lap joints or to prevent buckling of lapped parts and to join component parts of built-up members.

The diameter of the holes for a plug weld shall not be less than the thickness of the part containing it plus  $\frac{5}{16}$ -in. (8 mm), rounded to the next larger odd  $\frac{1}{16}$ -in. (even mm), nor greater than the minimum diameter plus  $\frac{1}{8}$ -in. (3 mm) or  $2\frac{1}{4}$  times the thickness of the weld.

The minimum center-to-center spacing of plug welds shall be four times the diameter of the hole.

The length of slot for a slot weld shall not exceed 10 times the thickness of the weld. The width of the slot shall be not less than the thickness of the part containing it plus  $\frac{5}{16}$ -in. (8 mm) rounded to the next larger odd  $\frac{1}{16}$ -in. (even mm), nor shall it be larger than  $2\frac{1}{4}$  times the thickness of the weld. The ends of the slot shall be semicircular or shall have the corners rounded to a radius of not less than the thickness of the part containing it, except those ends which extend to the edge of the part.

The minimum spacing of lines of slot welds in a direction transverse to their length shall be four times the width of the slot. The minimum center-to-center spacing in a longitudinal direction on any line shall be two times the length of the slot.

The thickness of plug or slot welds in material  $\frac{5}{8}$ -in. (16 mm) or less in thickness shall be equal to the thickness of the material. In material over  $\frac{5}{8}$ -in. (16 mm) thick, the thickness of the weld shall be at least one-half the thickness of the material but not less than  $\frac{5}{8}$ -in. (16 mm).

### 4. Design Strength

The design strength of welds shall be the lower value of (a)  $\phi F_{BM} A_{BM}$  and (b)  $\phi F_w A_w$ , when applicable. The values of  $\phi$ ,  $F_{BM}$ , and  $F_w$  and limitations thereon are given in Table J2.5,

where

- $F_{BM}$  = nominal strength of the base material, ksi (MPa)
- $F_w$  = nominal strength of the weld electrode, ksi (MPa)
- $A_{BM}$  = cross-sectional area of the base material, in.<sup>2</sup> (mm<sup>2</sup>)
- $A_w$  = effective cross-sectional area of the weld, in.<sup>2</sup> (mm<sup>2</sup>)
- $\phi$  = resistance factor

Alternatively, fillet welds loaded in-plane are permitted to be designed in accordance with Appendix J2.4.

**TABLE J2.5**  
**Design Strength of Welds**

Types of Weld and Stress [a]	Material	Resistance Factor $\phi$	Nominal Strength $F_{BM}$ or $F_w$	Filler Metal Requirements [b, c]
<b>Complete-Joint-Penetration Groove Weld</b>				
Tension normal to effective area	Base	0.90	$F_y$	Matching filler metal shall be used. For CVN requirements see footnote [d].
Compression normal to effective area	Base	0.90	$F_y$	Filler metal with a strength level equal to or less than matching filler metal is permitted to be used.
Tension or compression parallel to axis of weld				
Shear on effective area	Base Weld	0.90 0.80	$0.60F_y$ $0.60F_{EXX}$	
<b>Partial-Joint-Penetration Groove Weld</b>				
Compression normal to effective area	Base	0.90	$F_y$	Filler metal with a strength level equal to or less than matching filler metal is permitted to be used.
Tension or compression parallel to axis of weld [e]				
Shear parallel to axis of weld	Base Weld	[f] 0.75	[f] $0.60F_{EXX}$	
Tension normal to effective area	Base Weld	0.90 0.80	$F_y$ $0.60F_{EXX}$	
<b>Fillet Welds</b>				
Shear on effective area	Base Weld	[f] 0.75	[f] $0.60F_{EXX}$ [g]	Filler metal with a strength level equal to or less than matching filler metal is permitted to be used.
Tension or compression parallel to axis of weld [e]	Base	0.90	$F_y$	
<b>Plug or Slot Welds</b>				
Shear parallel to faying surfaces (on effective area)	Base Weld	[f] 0.75	[f] $0.60F_{EXX}$	Filler metal with a strength level equal to or less than matching filler metal is permitted to be used.
<p>[a] For definition of effective area, see Section J2.</p> <p>[b] For matching filler metal, see Table 3.1, AWS D1.1.</p> <p>[c] Filler metal one strength level stronger than matching filler metal is permitted.</p> <p>[d] For T and corner joints with the backing bar left in place during service, filler metal with a classification requiring a minimum Charpy V-notch (CVN) toughness of 20 ft-lbs. (27 J) @ +40°F (4°C) shall be used. If filler metal without the required toughness is used and the backing bar is left in place, the joint shall be sized using the resistance factor and nominal strength for a partial-joint-penetration weld.</p> <p>[e] Fillet welds and partial-joint-penetration groove welds joining component elements of built-up members, such as flange-to-web connections, are not required to be designed with regard to the tensile or compressive stress in these elements parallel to the axis of the welds.</p> <p>[f] The design of connected material is governed by Sections J4 and J5.</p> <p>[g] For alternative design strength, see Appendix J2.4.</p>				

## 5. Combination of Welds

If two or more of the general types of welds (groove, fillet, plug, slot) are combined in a single joint, the design strength of each shall be separately computed with reference to the axis of the group in order to determine the design strength of the combination.

## 6. Weld Metal Requirements

The choice of electrode for use with complete-joint-penetration groove welds subject to tension normal to the effective area shall comply with the requirements for matching weld metals given in AWS D1.1.

Weld metal with a specified Charpy V-notch (CVN) toughness of 20 ft-lbs (27 J) at 40°F (4°C) shall be used in the following joints:

- (a) Complete-joint-penetration groove welded T and corner joints with steel backing left in place, subject to tension normal to the effective area, unless the joints are designed as noted in Table J2.5 (see footnote d).
- (b) Complete-joint-penetration groove welded splices subject to tension normal to the effective area in Group 4 and Group 5 shapes and shapes built up by welding plates more than two in. (50 mm) thick.

The manufacturer's Certificate of Conformance shall be sufficient evidence of compliance.

## 7. Mixed Weld Metal

When notch-toughness is specified, the process consumables for all weld metal, tack welds, root pass, and subsequent passes deposited in a joint shall be compatible to assure notch-tough composite weld metal.

## 8. Preheat for Heavy Shapes

For ASTM A6/A6M Group 4 and 5 shapes and welded built-up members made of plates more than two in. (50 mm) thick, a preheat equal to or greater than 350°F (175°C) shall be used when making groove-weld splices.

# J3. BOLTS AND THREADED PARTS

## 1. High-Strength Bolts

Use of high-strength bolts shall conform to the provisions of the *Load and Resistance Factor Design Specification for Structural Joints Using ASTM A325 or A490 Bolts*, as approved by the Research Council on Structural Connections, except as otherwise provided in this Specification.

If required to be tightened to more than 50 percent of their specified minimum tensile strength, A449 bolts in tension and bearing-type shear connections shall have an ASTM F436 hardened washer installed under the bolt head, and the nuts shall meet the requirements of ASTM A563. When assembled, all joint surfaces, including those adjacent to the washers, shall be free of scale, except tight mill scale. All A325 or A325M and A490 or A490M bolts shall be tightened to a bolt tension not less than that given in Table J3.1 or J3.1M, except as noted below. Tightening shall be done by any of the following methods: turn-of-nut method, a direct tension indicator, calibrated wrench, or alternative design bolt.

Bolts need only be tightened to the snug-tight condition when in: (a) bearing-type connections where slip is permitted, or (b) tension or combined shear and tension applications, for ASTM A325 or A325M bolts only, where loosening or fatigue due to vibration or load fluctuations are not design considerations. The snug-tight condition is defined as the tightness attained by either a few impacts of an impact wrench or the full effort of a worker with an ordinary spud wrench that brings the connected plies into firm contact. The nominal strength value given in Table J3.2 and Table J3.5 shall be used for bolts tightened to the snug-tight condition. Bolts tightened only to the snug-tight condition shall be clearly identified on the design and erection drawings.

When A490 or A490M bolts over one in. (25 mm) in diameter are used in slotted or oversize holes in external plies, a single hardened washer conforming to ASTM F436, except with  $\frac{5}{16}$ -in. (8 mm) minimum thickness, shall be used in lieu of the standard washer.

In slip-critical connections in which the direction of loading is toward an edge of a connected part, adequate design bearing strength shall be provided based upon the applicable requirements of Section J3.10.

## 2. Size and Use of Holes

The *maximum sizes* of holes for rivets and bolts are given in Table J3.3 or J3.3M, except that larger holes, required for tolerance on location of anchor rods in concrete foundations, are allowed in column base details.

*Standard holes* shall be provided in member-to-member connections, unless oversized, short-slotted, or long-slotted holes in bolted connections are approved by the designer. Finger shims up to  $\frac{1}{4}$ -in. (6 mm) are permitted in slip-critical connections designed on the basis of standard holes without reducing the nominal shear strength of the fastener to that specified for slotted holes.

*Oversized holes* are allowed in any or all plies of slip-critical connections, but they shall not be used in bearing-type connections. Hardened washers shall be installed over oversized holes in an outer ply.

*Short-slotted holes* are allowed in any or all plies of slip-critical or bearing-type connections. The slots are permitted to be used without regard to direction of loading in slip-critical connections, but the length shall be normal to the direction of the load in bearing-type connections. Washers shall be installed over short-slotted holes in an outer ply; when high-strength bolts are used, such washers shall be hardened.

*Long-slotted holes* are allowed in only one of the connected parts of either a slip-critical or bearing-type connection at an individual faying surface. Long-slotted holes are permitted to be used without regard to direction of loading in slip-critical connections, but shall be normal to the direction of load in bearing-type connections. Where long-slotted holes are used in an outer ply, plate washers, or a continuous bar with standard holes, having a size sufficient to completely cover the slot after installation, shall be provided. In high-strength bolted connections, such plate washers or continuous bars shall be not less than  $\frac{5}{16}$ -in. (8 mm) thick and shall be of structural grade material, but need not be hardened. If hardened washers are required for use of high-strength bolts, the hardened washers shall be placed over the outer surface of the plate washer or bar.

**TABLE J3.1**  
**Minimum Bolt Pretension, kips\***

Bolt Size, in.	A325 Bolts	A490 Bolts
1/2	12	15
5/8	19	24
3/4	28	35
7/8	39	49
1	51	64
1 1/8	56	80
1 1/4	71	102
1 3/8	85	121
1 1/2	103	148

\*Equal to 0.70 of minimum tensile strength of bolts, rounded off to nearest kip, as specified in ASTM specifications for A325 and A490 bolts with UNC threads.

**TABLE J3.1M**  
**Minimum Bolt Pretension, kN\***

Bolt Size, mm	A325M Bolts	A490M Bolts
M16	91	114
M20	142	179
M22	176	221
M24	205	257
M27	267	334
M30	326	408
M36	475	595

\*Equal to 0.70 of minimum tensile strength of bolts, rounded off to nearest kN, as specified in ASTM specifications for A325M and A490M bolts with UNC threads.

### 3. Minimum Spacing

The distance between centers of standard, oversized, or slotted holes, shall not be less than  $2\frac{2}{3}$  times the nominal diameter of the fastener; a distance of  $3d$  is preferred. Refer to Section J3.10 for bearing strength requirements.

### 4. Minimum Edge Distance

The distance from the center of a standard hole to an edge of a connected part shall not be less than either the applicable value from Table J3.4 or J3.4M, or as required in Section J3.10. The distance from the center of an oversized or slotted hole to an edge of a connected part shall be not less than that required for a standard hole to an edge of a connected part plus the applicable increment  $C_2$  from Table J3.6 or J3.6M. Refer to Section J3.10 for bearing strength requirements.

### 5. Maximum Spacing and Edge Distance

The maximum distance from the center of any bolt or rivet to the nearest edge of parts in contact shall be 12 times the thickness of the connected part under consideration, but shall not exceed six in. (150 mm). The longitudinal spacing of connectors between elements in continuous contact consisting of a plate and a shape or two plates shall be as follows:

**TABLE J3.2**  
**Design Strength of Fasteners**

Description of Fasteners	Tensile Strength		Shear Strength in Bearing-type Connections	
	Resistance Factor $\phi$	Nominal Strength, ksi (MPa)	Resistance Factor $\phi$	Nominal Strength, ksi (MPa)
A307 bolts	0.75	45 (310) [a]	0.75	24 (165) [b,e]
A325 or A325M bolts, when threads are not excluded from shear planes		90 (620) [d]		48 (330) [e]
A325 or A325M bolts, when threads are excluded from shear planes		90 (620) [d]		60 (414) [e]
A490 or A490M bolts, when threads are not excluded from shear planes		113 (780) [d]		60 (414) [e]
A490 or A490M bolts, when threads are excluded from shear planes		113 (780) [d]		75 (520) [e]
Threaded parts meeting the requirements of Section A3, when threads are not excluded from shear planes		$0.75F_u$ [a,c]		$0.40F_u$
Threaded parts meeting the requirements of Section A3, when threads are excluded from shear planes		$0.75F_u$ [a,c]		$0.50F_u$ [a,c]
A502, Gr. 1, hot-driven Rivets		45 (310) [a]		25 (172) [e]
A502, Gr. 2 & 3, hot-driven Rivets		60 (414) [a]		33 (228) [e]

[a] Static loading only.  
[b] Threads permitted in shear planes.  
[c] The nominal tensile strength of the threaded portion of an upset rod, based upon the cross-sectional area at its major thread diameter,  $A_D$  shall be larger than the nominal body area of the rod before upsetting times  $F_u$ .  
[d] For A325 or A325M and A490 or A490M bolts subject to tensile fatigue loading, see Appendix K3.  
[e] When bearing-type connections used to splice tension members have a fastener pattern whose length, measured parallel to the line of force, exceeds 50 in. (1 270 mm), tabulated values shall be reduced by 20 percent.

- (a) For painted members or unpainted members not subject to corrosion, the spacing shall not exceed 24 times the thickness of the thinner plate or 12 in. (305 mm).
- (b) For unpainted members of weathering steel subject to atmospheric corrosion, the spacing shall not exceed 14 times the thickness of the thinner plate or seven-in. (180 mm).

**TABLE J3.3**  
**Nominal Hole Dimensions, in.**

Bolt Diameter	Hole Dimensions			
	Standard (Dia.)	Oversize (Dia.)	Short-slot (Width × Length)	Long-slot (Width × Length)
1/2	9/16	5/8	9/16 × 11/16	9/16 × 1 1/4
5/8	11/16	13/16	11/16 × 7/8	11/16 × 1 9/16
3/4	13/16	15/16	13/16 × 1	13/16 × 1 7/8
7/8	15/16	1 1/16	15/16 × 1 1/8	15/16 × 2 3/16
1	1 1/16	1 1/4	1 1/16 × 1 5/16	1 1/16 × 2 1/2
≥ 1 1/8	$d + 1/16$	$d + 5/16$	$(d + 1/16) \times (d + 3/8)$	$(d + 1/16) \times (2.5 \times d)$

**TABLE J3.3M**  
**Nominal Hole Dimensions, mm**

Bolt Diameter	Hole Dimensions			
	Standard (Dia.)	Oversize (Dia.)	Short-slot (Width × Length)	Long-slot (Width × Length)
M16	18	20	18 × 22	18 × 40
M20	22	24	22 × 26	22 × 50
M22	24	28	24 × 30	24 × 55
M24	27 [a]	30	27 × 32	27 × 60
M27	30	35	30 × 37	30 × 67
M30	33	38	33 × 40	33 × 75
≥ M36	$d + 3$	$d + 8$	$(d + 3) \times (d + 10)$	$(d + 3) \times 2.5d$

[a] Clearance provided allows the use of a 1 in. bolt if desirable.

## 6. Design Tension or Shear Strength

The design tension or shear strength of a high-strength bolt or threaded part is  $\phi F_n A_b$ ,

where

$\phi$  = resistance factor tabulated in Table J3.2

$F_n$  = nominal tensile strength  $F_t$ , or shear strength,  $F_v$ , tabulated in Table J3.2, ksi (MPa)

$A_b$  = nominal unthreaded body area of bolt or threaded part (for upset rods, see Footnote c, Table J3.2), in.<sup>2</sup> (mm<sup>2</sup>)

The applied load shall be the sum of the factored loads and any tension resulting from prying action produced by deformation of the connected parts.

**TABLE J3.4**  
**Minimum Edge Distance,<sup>[a]</sup> in., From**  
**Center of Standard Hole<sup>[b]</sup> to Edge of Connected Part**

Nominal Rivet or Bolt Diameter (in.)	At Sheared Edges	At Rolled Edges of Plates, Shapes or Bars, or Gas Cut Edges [c]
1/2	7/8	3/4
5/8	1 1/8	7/8
3/4	1 1/4	1
7/8	1 1/2 [d]	1 1/8
1	1 3/4 [d]	1 1/4
1 1/8	2	1 1/2
1 1/4	2 1/4	1 5/8
Over 1 1/4	1 3/4 × Diameter	1 1/4 × Diameter

[a] Lesser edge distances are permitted to be used provided Equations from Section J3.10, as appropriate, are satisfied.

[b] For oversized or slotted holes, see Table J3.6.

[c] All edge distances in this column are permitted to be reduced 1/8-in. when the hole is at a point where stress does not exceed 25 percent of the maximum design strength in the element.

[d] These are permitted to be 1 1/4-in. at the ends of beam connection angles and shear end plates.

**TABLE J3.4M**  
**Minimum Edge Distance,<sup>[a]</sup> mm, From**  
**Center of Standard Hole<sup>[b]</sup> to Edge of Connected Part**

Nominal Rivet or Bolt Diameter (mm)	At Sheared Edges	At Rolled Edges of Plates, Shapes or Bars, or Gas Cut Edges [c]
16	28	22
20	34	26
22	38 [d]	28
24	42 [d]	30
27	48	34
30	52	38
36	64	46
Over 36	1.75d	1.25d

[a] Lesser edge distances are permitted to be used provided Equations from Section J3.10, as appropriate, are satisfied.

[b] For oversized or slotted holes, see Table J3.6M.

[c] All edge distances in this column are permitted to be reduced 3 mm when the hole is at a point where stress does not exceed 25 percent of the maximum design strength in the element.

[d] These are permitted to be 32 mm at the ends of beam connection angles and shear end plates.

## 7. Combined Tension and Shear in Bearing-Type Connections

The design strength of a bolt or rivet subject to combined tension and shear is  $\phi F_t A_b$ ,

where

$$\phi = 0.75$$



$F_t$  = nominal tension stress computed from the equations in Table J3.5 as a function of  $f_v$ , the required shear stress produced by the factored loads. Alternatively, the use of the equations in Table A-J3.1 in Appendix J is permitted. The design shear strength  $\phi F_v$ , tabulated in Table J3.2, shall equal or exceed the shear stress,  $f_v$ .

## 8. High-Strength Bolts in Slip-Critical Connections

The design for shear of high-strength bolts in slip-critical connections shall be in accordance with either Section J3.8a or J3.8b and checked for shear in accordance with Sections J3.6 and J3.7 and bearing in accordance with Sections J3.1 and J3.10.

### 8a. Slip-Critical Connections Designed at Factored Loads

The design slip resistance per bolt,  $\phi r_{str}$ , shall equal or exceed the required force per bolt due to factored loads,

where

$$r_{str} = 1.13 \mu T_b N_s \quad (\text{J3-1})$$

$T_b$  = minimum fastener tension given in Table J3.1 or J3.1M, kips (kN)

$N_s$  = number of slip planes

$\mu$  = mean slip coefficient for Class A, B, or C surfaces, as applicable, or as established by tests

- (a) For Class A surfaces (unpainted clean mill scale steel surfaces or surfaces with Class A coatings on blast-cleaned steel),

$$\mu = 0.33$$

- (b) For Class B surfaces (unpainted blast-cleaned steel surfaces or surfaces with Class B coatings on blast-cleaned steel),

$$\mu = 0.50$$

- (c) For Class C surfaces (hot-dip galvanized and roughened surfaces),

$$\mu = 0.35$$

$\phi$  = resistance factor

- (a) For standard holes,

$$\phi = 1.0$$

- (b) For oversized and short-slotted holes,

$$\phi = 0.85$$

- (c) For long-slotted holes transverse to the direction of load,

$$\phi = 0.70$$

- (d) For long-slotted holes parallel to the direction of load,

$$\phi = 0.60$$

Finger shims up to  $\frac{1}{4}$ -in. (6 mm) are permitted to be introduced into slip-critical

**TABLE J3.5**  
Nominal Tension Stress ( $F_t$ ), ksi (MPa)  
Fasteners in Bearing-type Connections

Description of Fasteners	Threads Included in the Shear Plane	Threads Excluded from the Shear Plane
A307 bolts	$59 - 2.5f_v \leq 45$ ( $171 - 2.5f_v \leq 310$ )	
A325 bolts A325M bolts	$117 - 2.5f_v \leq 90$ ( $807 - 2.5f_v \leq 621$ )	$117 - 2.0f_v \leq 90$ ( $807 - 2.0f_v \leq 621$ )
A490 bolts A490M bolts	$147 - 2.5f_v \leq 113$ ( $1010 - 2.5f_v \leq 779$ )	$147 - 2.0f_v \leq 113$ ( $1010 - 2.0f_v \leq 779$ )
Threaded parts A449 bolts over $1\frac{1}{2}$ diameter	$0.98F_u - 2.5f_v \leq 0.75F_u$	$0.98F_u - 2.0f_v \leq 0.75F_u$
A502 Gr. 1 rivets	$59 - 2.4f_v \leq 45$ ( $407 - 2.4f_v \leq 310$ )	
A502 Gr. 2 rivets	$78 - 2.4f_v \leq 60$ ( $538 - 2.4f_v \leq 414$ )	

**TABLE J3.6**  
Values of Edge Distance Increment  $C_2$ , in.

Nominal Diameter of Fastener (in.)	Oversized Holes	Slotted Holes		
		Long Axis Perpendicular to Edge		Long Axis Parallel to Edge
		Short Slots	Long Slots [a]	
$\leq \frac{7}{8}$	$\frac{1}{16}$	$\frac{1}{8}$	$\frac{3}{4}d$	0
1	$\frac{1}{8}$	$\frac{1}{8}$		
$\geq 1\frac{1}{8}$	$\frac{1}{8}$	$\frac{3}{16}$		

[a] When length of slot is less than maximum allowable (see Table J3.5),  $C_2$  are permitted to be reduced by one-half the difference between the maximum and actual slot lengths.

**TABLE J3.6M**  
Values of Edge Distance Increment  $C_2$ , mm

Nominal Diameter of Fastener (mm)	Oversized Holes	Slotted Holes		
		Long Axis Perpendicular to Edge		Long Axis Parallel to Edge
		Short Slots	Long Slots [a]	
$\leq 22$	2	3	$0.75d$	0
24	3	3		
$\geq 27$	3	5		

[a] When length of slot is less than maximum allowable (see Table J3.5),  $C_2$  are permitted to be reduced by one-half the difference between the maximum and actual slot lengths.

connections designed on the basis of standard holes without reducing the design shear stress of the fastener to that specified for slotted holes.

### 8b. Slip-Critical Connections Designed at Service Loads

See Appendix J3.8b.

## 9. Combined Tension and Shear in Slip-Critical Connections

The design of slip-critical connections subject to tensile forces shall be in accordance with either Sections J3.9a and J3.8a or Sections J3.9b and J3.8b.

### 9a. Slip-Critical Connections Designed at Factored Loads

When a slip-critical connection is subjected to an applied tension  $T_u$  that reduces the net clamping force, the slip resistance  $\phi r_{str}$  according to Section J3.8a, shall be multiplied by the following factor:

$$1 - \frac{T_u}{(1.13T_b N_b)}$$

where

$T_b$  = minimum bolt pre-tension from Table J3.1or J3.1M, kips (kN)

$N_b$  = number of bolts carrying factored-load tension  $T_u$

### 9b. Slip-Critical Connections Designed at Service Loads

See Appendix J3.9b.

## 10. Bearing Strength at Bolt Holes

Bearing strength shall be checked for both bearing-type and slip-critical connections. The use of oversized holes and short- and long-slotted holes parallel to the line of force is restricted to slip-critical connections per Section J3.2.

The design bearing strength at bolt holes is  $\phi R_n$ ,

where

$$\phi = 0.75$$

and  $R_n$  is determined as follows:

- (a) For a bolt in a connection with standard, oversized, and short-slotted holes independent of the direction of loading, or a long-slotted hole with the slot parallel to the direction of the bearing force:

when deformation at the bolt hole at service load is a design consideration:

$$R_n = 1.2L_c t F_u \leq 2.4dt F_u \quad (\text{J3-2a})$$

when deformation at the bolt hole at service load is not a design consideration:

$$R_n = 1.5L_c t F_u \leq 3.0dt F_u \quad (\text{J3-2b})$$

- (b) For a bolt in a connection with long-slotted holes with the slot perpendicular to the direction of force:

$$R_n = 1.0L_c t F_u \leq 2.0dt F_u \quad (\text{J3-2c})$$

In the foregoing,

$R_n$  = nominal bearing strength of the connected material, kips (N)

$F_u$  = specified minimum tensile strength of the connected material, ksi (MPa)

$L_c$  = clear distance, in the direction of the force, between the edge of the hole and the edge of the adjacent hole or edge of the material, in. (mm)

$d$  = nominal bolt diameter, in. (mm)

$t$  = thickness of connected material, in. (mm)

For connections, the bearing resistance shall be taken as the sum of the bearing resistances of the individual bolts.

## 11. Long Grips

A307 bolts providing design strength, and for which the grip exceeds five diameters, shall have their number increased one percent for each additional  $\frac{1}{16}$ -in. (2 mm) in the grip.

## J4. DESIGN RUPTURE STRENGTH

### 1. Shear Rupture Strength

The design strength for the limit state of rupture along a shear failure path in the affected elements of connected members shall be taken as  $\phi R_n$

where

$$\begin{aligned}\phi &= 0.75 \\ R_n &= 0.6F_u A_{nv} \\ A_{nv} &= \text{net area subject to shear, in.}^2 \text{ (mm}^2\text{)}\end{aligned}\tag{J4-1}$$

### 2. Tension Rupture Strength

The design strength for the limit state of rupture along a tension path in the affected elements of connected members shall be taken as  $\phi R_n$

where

$$\begin{aligned}\phi &= 0.75 \\ R_n &= F_u A_{nt} \\ A_{nt} &= \text{net area subject to tension, in.}^2 \text{ (mm}^2\text{)}\end{aligned}\tag{J4-2}$$

### 3. Block Shear Rupture Strength

Block shear is a limit state in which the resistance is determined by the sum of the shear strength on a failure path(s) and the tensile strength on a perpendicular segment. It shall be checked at beam end connections where the top flange is coped and in similar situations, such as tension members and gusset plates. When ultimate rupture strength on the net section is used to determine the resistance on one segment, yielding on the gross section shall be used on the perpendicular segment. The block shear rupture design strength,  $\phi R_n$ , shall be determined as follows:

(a) When  $F_u A_{nt} \geq 0.6F_u A_{nv}$ :

$$\phi R_n = \phi[0.6F_y A_{gv} + F_u A_{nt}] \leq \phi[0.6F_u A_{nv} + F_u A_{nt}]\tag{J4-3a}$$

(b) When  $F_u A_{nt} < 0.6F_u A_{nv}$ :

$$\phi R_n = \phi[0.6F_u A_{nv} + F_y A_{gt}] \leq \phi[0.6F_u A_{nv} + F_u A_{nt}] \quad (J4-3b)$$

where

$$\phi = 0.75$$

$$A_{gv} = \text{gross area subject to shear, in.}^2 \text{ (mm}^2\text{)}$$

$$A_{gt} = \text{gross area subject to tension, in.}^2 \text{ (mm}^2\text{)}$$

$$A_{nv} = \text{net area subject to shear, in.}^2 \text{ (mm}^2\text{)}$$

$$A_{nt} = \text{net area subject to tension, in.}^2 \text{ (mm}^2\text{)}$$

## J5. CONNECTING ELEMENTS

This section applies to the design of connecting elements, such as plates, gussets, angles, brackets, and the panel zones of beam-to-column connections.

### 1. Eccentric Connections

Intersecting axially stressed members shall have their gravity axis intersect at one point, if practicable; if not, provision shall be made for bending and shearing stresses due to the eccentricity. Also see Section J1.8.

### 2. Design Strength of Connecting Elements in Tension

The design strength,  $\phi R_n$ , of welded, bolted, and riveted connecting elements statically loaded in tension (e.g., splice and gusset plates) shall be the lower value obtained according to limit states of yielding, rupture of the connecting element, and block shear rupture.

(a) For tension yielding of the connecting element:

$$\phi = 0.90$$

$$R_n = A_g F_y \quad (J5-1)$$

(b) For tension rupture of the connecting element:

$$\phi = 0.75$$

$$R_n = A_n F_u \quad (J5-2)$$

where  $A_n$  is the net area, not to exceed  $0.85A_g$ .

(c) For block shear rupture of connecting elements, see Section J4.3.

### 3. Other Connecting Elements

For all other connecting elements, the design strength,  $\phi R_n$ , shall be determined for the applicable limit state to ensure that the design strength is equal to or greater than the required strength, where  $R_n$  is the nominal strength appropriate to the geometry and type of loading on the connecting element. For shear yielding of the connecting element:

$$\phi = 0.90$$

$$R_n = 0.60A_g F_y \quad (J5-3)$$

If the connecting element is in compression an appropriate limit state analysis shall be made.

## J6. FILLERS

In welded construction, any filler  $\frac{1}{4}$ -in. (6 mm) or more in thickness shall extend beyond the edges of the splice plate and shall be welded to the part on which it is fitted with sufficient weld to transmit the splice plate load, applied at the surface of the filler. The welds joining the splice plate to the filler shall be sufficient to transmit the splice plate load and shall be long enough to avoid overloading the filler along the toe of the weld. Any filler less than  $\frac{1}{4}$ -in. (6 mm) thick shall have its edges made flush with the edges of the splice plate and the weld size shall be the sum of the size necessary to carry the splice plus the thickness of the filler plate.

When a bolt that carries load passes through fillers that are equal to or less than  $\frac{1}{4}$ -in. (6 mm) thick, the design shear strength shall be used without reduction. When a bolt that carries load passes through fillers that are greater than  $\frac{1}{4}$ -in. (6 mm) thick, one of the following requirements shall apply:

- (1) For fillers that are equal to or less than  $\frac{3}{4}$ -in. (19 mm) thick, the design shear strength of the bolts shall be multiplied by the factor  $[1 - 0.4(t - 0.25)]$  [Metric:  $[1 - 0.0154(t - 6)]]$ , where  $t$  is the total thickness of the fillers up to  $\frac{3}{4}$ -in. (19 mm).
- (2) The fillers shall be extended beyond the joint and the filler extension shall be secured with enough bolts to uniformly distribute the total force in the connected element over the combined cross-section of the connected element and the fillers;
- (3) The size of the joint shall be increased to accommodate a number of bolts that is equivalent to the total number required in (2) above; or
- (4) The joint shall be designed as a slip-critical joint.

## J7. SPLICES

Groove-welded splices in plate girders and beams shall develop the full strength of the smaller spliced section. Other types of splices in cross sections of plate girders and beams shall develop the strength required by the forces at the point of the splice.

## J8. BEARING STRENGTH

The strength of surfaces in bearing is  $\phi R_n$ ,

where

$$\phi = 0.75$$

$R_n$  is defined below for the various types of bearing

- (a) For milled surfaces, pins in reamed, drilled, or bored holes, and ends of fitted bearing stiffeners,

$$R_n = 1.8F_y A_{pb} \tag{J8-1}$$

where

$F_y$  = specified minimum yield stress, ksi (MPa)

$A_{pb}$  = projected bearing area, in.<sup>2</sup> (mm<sup>2</sup>)

- (b) For expansion rollers and rockers,

If  $d \leq 25$  in. (635 mm),

$$R_n = 1.2(F_y - 13)ld / 20 \quad (\text{J8-2})$$

$$(\text{Metric: } R_n = 1.2(F_y - 90)ld / 20) \quad (\text{J8-2M})$$

If  $d > 25$  in. (635 mm),

$$R_n = 6.0(F_y - 13)l\sqrt{d} / 20 \quad (\text{J8-3})$$

$$(\text{Metric: } R_n = 6.0(F_y - 90)l\sqrt{d} / 20) \quad (\text{J8-3M})$$

where

$d$  = diameter, in. (mm)

$l$  = length of bearing, in. (mm)

## J9. COLUMN BASES AND BEARING ON CONCRETE

Proper provision shall be made to transfer the column loads and moments to the footings and foundations.

In the absence of code regulations, design bearing loads on concrete may be taken as  $\phi_c P_p$ :

(a) On the full area of a concrete support

$$P_p = 0.85f'_c A_1 \quad (\text{J9-1})$$

(b) On less than the full area of a concrete support

$$P_p = 0.85f'_c A_1 \sqrt{A_2 / A_1} \quad (\text{J9-2})$$

where

$\phi_c = 0.60$

$A_1$  = area of steel concentrically bearing on a concrete support, in.<sup>2</sup> (mm<sup>2</sup>)

$A_2$  = maximum area of the portion of the supporting surface that is geometrically similar to and concentric with the loaded area, in.<sup>2</sup> (mm<sup>2</sup>)

$\sqrt{A_2 / A_1} \leq 2$

## J10. ANCHOR RODS AND EMBEDMENTS

Steel anchor rods and embedments shall be proportioned to develop the factored load combinations stipulated in Section A4. If the load factors and combinations stipulated in Section A4 are used to design concrete structural elements, the provisions of ACI 318 shall be used with appropriate  $\phi$  factors as given in ACI 318, Appendix C.

## CHAPTER K

### CONCENTRATED FORCES, PONDING, AND FATIGUE

This chapter covers member strength design considerations pertaining to concentrated forces, ponding, and fatigue.

#### K1. FLANGES AND WEBS WITH CONCENTRATED FORCES

##### 1. Design Basis

Sections K1.2 through K1.7 apply to single and double concentrated forces as indicated in each Section. A single concentrated force is tensile or compressive. Double concentrated forces, one tensile and one compressive, form a couple on the same side of the loaded member.

Transverse stiffeners are required at locations of concentrated tensile forces in accordance with Section K1.2 for the limit state of flange local bending, and at unframed ends of beams and girders in accordance with Section K1.8. Transverse stiffeners or doubler plates are required at locations of concentrated forces in accordance with Sections K1.3 through K1.6 for the limit states of web local yielding, crippling, sidesway buckling, and compression buckling. Doubler plates or diagonal stiffeners are required in accordance with Section K1.7 for the limit state of web panel-zone shear.

Transverse stiffeners and diagonal stiffeners required by Sections K1.2 through K1.8 shall also meet the requirements of Section K1.9. Doubler plates required by Sections K1.3 through K1.6 shall also meet the requirements of Section K1.10.

##### 2. Flange Local Bending

This Section applies to both tensile single-concentrated forces and the tensile component of double-concentrated forces.

A pair of transverse stiffeners extending at least one-half the depth of the web shall be provided adjacent to a concentrated tensile force centrally applied across the flange when the required strength of the flange exceeds  $\phi R_n$ ,

where

$$\phi = 0.90$$

$$R_n = 6.25t_f^2 F_{yf} \quad (\text{K1-1})$$

$F_{yf}$  = specified minimum yield stress of the flange, ksi (MPa)

$t_f$  = thickness of the loaded flange, in. (mm)

If the length of loading across the member flange is less than  $0.15b$ , where  $b$  is the member flange width, Equation K1-1 need not be checked.



When the concentrated force to be resisted is applied at a distance from the member end that is less than  $10t_f$ ,  $R_n$  shall be reduced by 50 percent.

When transverse stiffeners are required, they shall be welded to the loaded flange to develop the welded portion of the stiffener. The weld connecting transverse stiffeners to the web shall be sized to transmit the unbalanced force in the stiffener to the web. Also, see Section K1.9.

### 3. Web Local Yielding

This Section applies to single-concentrated forces and both components of double-concentrated forces.

Either a pair of transverse stiffeners or a doubler plate, extending at least one-half the depth of the web, shall be provided adjacent to a concentrated tensile or compressive force when the required strength of the web at the toe of the fillet exceeds  $\phi R_n$ ,

where

$$\phi = 1.0$$

and  $R_n$  is determined as follows:

- (a) When the concentrated force to be resisted is applied at a distance from the member end that is greater than the depth of the member  $d$ ,

$$R_n = (5k + N)F_{yw} t_w \quad (\text{K1-2})$$

- (b) When the concentrated force to be resisted is applied at a distance from the member end that is less than or equal to the depth of the member  $d$ ,

$$R_n = (2.5k + N)F_{yw} t_w \quad (\text{K1-3})$$

In Equations K1-2 and K1-3, the following definitions apply:

$F_{yw}$  = specified minimum yield stress of the web, ksi (MPa)

$N$  = length of bearing (not less than  $k$  for end beam reactions), in. (mm)

$k$  = distance from outer face of the flange to the web toe of the fillet, in. (mm)

$t_w$  = web thickness, in. (mm)

When required, for a tensile force normal to the flange, transverse stiffeners shall be welded to the loaded flange to develop the connected portion of the stiffener. When required for a compressive force normal to the flange, transverse stiffeners shall either bear on or be welded to the loaded flange to develop the force transmitted to the stiffener. The weld connecting transverse stiffeners to the web shall be sized to transmit the unbalanced force in the stiffener to the web. Also, see Section K1.9.

Alternatively, when doubler plates are required, see Section K1.10.

### 4. Web Crippling

This Section applies to both compressive single-concentrated forces and the compressive component of double-concentrated forces.

Either a transverse stiffener, a pair of transverse stiffeners, or a doubler plate, extending at least one-half the depth of the web, shall be provided adjacent to a concentrated compressive force when the required strength of the web exceeds  $\phi R_n$ ,

where

$$\phi = 0.75$$

and  $R_n$  is determined as follows:

- (a) When the concentrated compressive force to be resisted is applied at a distance from the member end that is greater than or equal to  $d/2$ ,

$$R_n = 0.80t_w^2 \left[ 1 + 3 \left( \frac{N}{d} \right) \left( \frac{t_w}{t_f} \right)^{1.5} \right] \sqrt{\frac{EF_{yw}t_f}{t_w}} \quad (\text{K1-4})$$

- (b) When the concentrated compressive force to be resisted is applied at a distance from the member end that is less than  $d/2$ ,

For  $N/d \leq 0.2$ ,

$$R_n = 0.40t_w^2 \left[ 1 + 3 \left( \frac{N}{d} \right) \left( \frac{t_w}{t_f} \right)^{1.5} \right] \sqrt{\frac{EF_{yw}t_f}{t_w}} \quad (\text{K1-5a})$$

For  $N/d > 0.2$ ,

$$R_n = 0.40t_w^2 \left[ 1 + \left( \frac{4N}{d} - 0.2 \right) \left( \frac{t_w}{t_f} \right)^{1.5} \right] \sqrt{\frac{EF_{yw}t_f}{t_w}} \quad (\text{K1-5b})$$

In Equations K1-4 and K1-5, the following definitions apply:

$d$  = overall depth of the member, in. (mm)

$t_f$  = flange thickness, in. (mm)

When transverse stiffeners are required, they shall either bear on or be welded to the loaded flange to develop the force transmitted to the stiffener. The weld connecting transverse stiffeners to the web shall be sized to transmit the unbalanced force in the stiffener to the web. Also, see Section K1.9.

Alternatively, when doubler plates are required, see Section K1.10.

## 5. Web Sidesway Buckling

This Section applies only to compressive single-concentrated forces applied to members where relative lateral movement between the loaded compression flange and the tension flange is not restrained at the point of application of the concentrated force.

The design strength of the web is  $\phi R_n$ ,

where

$$\phi = 0.85$$

and  $R_n$  is determined as follows:

- (a) If the compression flange is restrained against rotation:

$$\text{For } (h/t_w)/(l/b_f) \leq 2.3,$$

$$R_n = \frac{C_r t_w^3 t_f}{h^2} \left[ 1 + 0.4 \left( \frac{h/t_w}{l/b_f} \right)^3 \right] \quad (\text{K1-6})$$

for  $(h/t_w)/(l/b_f) > 2.3$ , the limit state of sidesway web buckling does not apply.

When the required strength of the web exceeds  $\phi R_n$ , local lateral bracing shall be provided at the tension flange or either a pair of transverse stiffeners or a doubler plate, extending at least one-half the depth of the web, shall be provided adjacent to the concentrated compressive force.

When transverse stiffeners are required, they shall either bear on or be welded to the loaded flange to develop the full-applied force. The weld connecting transverse stiffeners to the web shall be sized to transmit the force in the stiffener to the web. Also, see Section K1.9.

Alternatively, when doubler plates are required, they shall be sized to develop the full-applied force. Also, see Section K1.10.

(b) If the compression flange is *not* restrained against rotation:

For  $(h/t_w)/(l/b_f) \leq 1.7$ ,

$$R_n = \frac{C_r t_w^3 t_f}{h^2} \left[ 0.4 \left( \frac{h/t_w}{l/b_f} \right)^3 \right] \quad (\text{K1-7})$$

for  $(h/t_w)/(l/b_f) > 1.7$ , the limit state of sidesway web buckling does not apply.

When the required strength of the web exceeds  $\phi R_n$ , local lateral bracing shall be provided at both flanges at the point of application of the concentrated forces.

In Equations K1-6 and K1-7, the following definitions apply:

$l$  = largest laterally unbraced length along either flange at the point of load, in. (mm)

$b_f$  = flange width, in. (mm)

$t_f$  = flange thickness, in. (mm)

$t_w$  = web thickness, in. (mm)

$h$  = clear distance between flanges less the fillet or corner radius for rolled shapes; distance between adjacent lines of fasteners or the clear distance between flanges when welds are used for built-up shapes, in. (mm)

$C_r$  = 960,000 ksi (6.62x10<sup>6</sup> MPa) when  $M_u < M_y$  at the location of the force

= 480,000 ksi (3.31x10<sup>6</sup> MPa) when  $M_u \geq M_y$  at the location of the force

## 6. Web Compression Buckling

This Section applies to a pair of compressive single-concentrated forces or the compressive components in a pair of double-concentrated forces, applied at both flanges of a member at the same location.

Either a single transverse stiffener, or pair of transverse stiffeners, or a doubler plate, extending the full depth of the web, shall be provided adjacent to concentrated compressive forces at both flanges when the required strength of the web exceeds  $\phi R_n$ ,

where

$$\phi = 0.90$$

and

$$R_n = \frac{24t_w^3 \sqrt{EF_{yw}}}{h} \quad (\text{K1-8})$$

When the pair of concentrated compressive forces to be resisted is applied at a distance from the member end that is less than  $d/2$ ,  $R_n$  shall be reduced by 50 percent.

When transverse stiffeners are required, they shall either bear on or be welded to the loaded flange to develop the force transmitted to the stiffener. The weld connecting transverse stiffeners to the web shall be sized to transmit the unbalanced force in the stiffener to the web. Also, see Section K1.9.

Alternatively, when doubler plates are required, see Section K1.10.

## 7. Web Panel-Zone Shear

Either doubler plates or diagonal stiffeners shall be provided within the boundaries of the rigid connection of members whose webs lie in a common plane when the required strength exceeds  $\phi R_v$ ,

where

$$\phi = 0.90$$

and  $R_v$  is determined as follows:

- (a) When the effect of panel-zone deformation on frame stability is *not* considered in the analysis,

$$\text{For } P_u \leq 0.4P_y$$

$$R_v = 0.60F_y d_c t_w \quad (\text{K1-9})$$

$$\text{For } P_u > 0.4P_y$$

$$R_v = 0.60F_y d_c t_w \left( 1.4 - \frac{P_u}{P_y} \right) \quad (\text{K1-10})$$

- (b) When frame stability, including plastic panel-zone deformation, is considered in the analysis:

$$\text{For } P_u \leq 0.75P_y$$

$$R_v = 0.60F_y d_c t_w \left( 1 + \frac{3b_{cf} t_{cf}^2}{d_b d_c t_w} \right) \quad (\text{K1-11})$$

$$\text{For } P_u > 0.75P_y$$

$$R_v = 0.60F_y d_c t_w \left( 1 + \frac{3b_{cf} t_{cf}^2}{d_b d_c t_w} \right) \left( 1.9 - \frac{1.2P_u}{P_y} \right) \quad (\text{K1-12})$$

In Equations K1-9 through K1-12, the following definitions apply:

- $t_w$  = column web thickness, in. (mm)
- $b_{cf}$  = width of column flange, in. (mm)
- $t_{cf}$  = thickness of the column flange, in. (mm)
- $d_b$  = beam depth, in. (mm)
- $d_c$  = column depth, in. (mm)
- $F_y$  = yield strength of the column web, ksi (MPa)
- $P_y = F_y A$ , axial yield strength of the column, kips (N)
- $A$  = column cross-sectional area, in.<sup>2</sup> (mm<sup>2</sup>)

When doubler plates are required, they shall meet the criteria of Section F2 and shall be welded to develop the proportion of the total shear force which is to be carried.

Alternatively, when diagonal stiffeners are required, the weld connecting diagonal stiffeners to the web shall be sized to transmit the stiffener force caused by unbalanced moments to the web. Also, see Section K1.9.

## 8. Unframed Ends of Beams and Girders

At unframed ends of beams and girders not otherwise restrained against rotation about their longitudinal axes, a pair of transverse stiffeners, extending the full depth of the web, shall be provided. Also, see Section K1.9.

## 9. Additional Stiffener Requirements for Concentrated Forces

Transverse and diagonal stiffeners shall also comply with the following criteria:

- (1) The width of each stiffener plus one-half the thickness of the column web shall not be less than one-third of the width of the flange or moment connection plate delivering the concentrated force.
- (2) The thickness of a stiffener shall not be less than one-half the thickness of the flange or moment connection plate delivering the concentrated load, and not less than its width times  $1.79\sqrt{F_y / E}$ .

Full depth transverse stiffeners for compressive forces applied to a beam or plate girder flange shall be designed as axially compressed members (columns) in accordance with the requirements of Section E2, with an effective length of  $0.75h$ , a cross section composed of two stiffeners and a strip of the web having a width of  $25t_w$  at interior stiffeners and  $12t_w$  at the ends of members.

The weld connecting bearing stiffeners to the web shall be sized to transmit the excess web shear force to the stiffener. For fitted bearing stiffeners, see Section J8.

## 10. Additional Doubler Plate Requirements for Concentrated Forces

Doubler plates required by Sections K1.3 through K1.6 shall also comply with the following criteria:

- (1) The thickness and extent of the doubler plate shall provide the additional material necessary to equal or exceed the strength requirements.
- (2) The doubler plate shall be welded to develop the proportion of the total force transmitted to the doubler plate.

## K2. PONDING

The roof system shall be investigated by structural analysis to assure adequate strength and stability under ponding conditions, unless the roof surface is provided with sufficient slope toward points of free drainage or adequate individual drains to prevent the accumulation of rainwater.

The roof system shall be considered stable and no further investigation is needed if:

$$C_p + 0.9C_s \leq 0.25 \quad (\text{K2-1})$$

$$I_d \geq 25(S^4)10^{-6} \quad (\text{K2-2})$$

$$(\text{Metric: } I_d \geq 3\,940\,S^4) \quad (\text{K2-2M})$$

where

$$C_p = \frac{32L_s L_p^4}{10^7 I_p}$$

$$\left( \text{Metric: } C_p = \frac{504L_s L_p^4}{I_p} \right)$$

$$C_s = \frac{32S L_s^4}{10^7 I_s}$$

$$\left( \text{Metric: } C_s = \frac{504S L_s^4}{I_s} \right)$$

$L_p$  = column spacing in direction of girder (length of primary members), ft (m)

$L_s$  = column spacing perpendicular to direction of girder (length of secondary members), ft (m)

$S$  = spacing of secondary members, ft (m)

$I_p$  = moment of inertia of primary members, in.<sup>4</sup> (mm<sup>4</sup>)

$I_s$  = moment of inertia of secondary members, in.<sup>4</sup> (mm<sup>4</sup>)

$I_d$  = moment of inertia of the steel deck supported on secondary members, in.<sup>4</sup> per ft (mm<sup>4</sup> per m)

For trusses and steel joists, the moment of inertia  $I_s$  shall be decreased 15 percent when used in the above equation. A steel deck shall be considered a secondary member when it is directly supported by the primary members.

See Appendix K2 for an alternate determination of flat roof framing stiffness.

## K3. DESIGN FOR CYCLIC LOADING (FATIGUE)

Few members or connections in conventional buildings need to be designed for

fatigue, since most load changes in such structures occur only a small number of times or produce only minor stress fluctuations. The occurrence of full design wind or earthquake loads is too infrequent to warrant consideration in fatigue design. However, crane runways and supporting structures for machinery and equipment are often subject to fatigue loading conditions.

Members and their connections subject to fatigue loading shall be proportioned in accordance with the provisions of Appendix K3 for service loads.

# CHAPTER L

## SERVICEABILITY DESIGN CONSIDERATIONS

This chapter is intended to provide design guidance for serviceability considerations.

Serviceability is a state in which the function of a building, its appearance, maintainability, durability, and comfort of its occupants are preserved under normal usage. The general design requirement for serviceability is given in Section A5.4. Limiting values of structural behavior to ensure serviceability (e.g., maximum deflections, accelerations, etc.) shall be chosen with due regard to the intended function of the structure. Where necessary, serviceability shall be checked using realistic loads for the appropriate serviceability limit state.

### L1. CAMBER

If any special camber requirements are necessary to bring a loaded member into proper relation with the work of other trades, as for the attachment of runs of sash, the requirements shall be set forth in the design documents. If camber involves the erection of any member under a preload, this shall be noted in the design documents.

Beams and trusses detailed without specified camber shall be fabricated so that after erection any camber due to rolling or shop assembly shall be upward.

### L2. EXPANSION AND CONTRACTION

Adequate provision shall be made for expansion and contraction appropriate to the service conditions of the structure.

### L3. DEFLECTIONS, VIBRATION, AND DRIFT

#### 1. Deflections

Deformations in structural members and structural systems due to service loads shall not impair the serviceability of the structure.

#### 2. Floor Vibration

Vibration shall be considered in designing beams and girders supporting large areas free of partitions or other sources of damping where excessive vibration due to pedestrian traffic or other sources within the building is not acceptable.

#### 3. Drift

Lateral deflection or drift of structures due to code-specified wind or seismic loads shall not cause collision with adjacent structures nor exceed the limiting values of such drifts which may be specified or appropriate.



**L4. CONNECTION SLIP**

For the design of slip-critical connections see Sections J3.8 and J3.9.

**L5. CORROSION**

When appropriate, structural components shall be designed to tolerate corrosion or shall be protected against corrosion that may impair the strength or serviceability of the structure.

## CHAPTER M

### FABRICATION, ERECTION, AND QUALITY CONTROL

This chapter provides requirements for shop drawings, fabrication, shop painting, erection, and quality control.

#### M1. SHOP DRAWINGS

Shop drawings giving complete information necessary for the fabrication of the component parts of the structure, including the location, type, and size of all welds, bolts, and rivets, shall be prepared in advance of the actual fabrication. These drawings shall clearly distinguish between shop and field welds and bolts and shall clearly identify pretensioned and slip-critical high-strength bolted connections.

Shop drawings shall be made in conformity with good practice and with due regard to speed and economy in fabrication and erection.

#### M2. FABRICATION

##### 1. Cambering, Curving, and Straightening

Local application of heat or mechanical means is permitted to be used to introduce or correct camber, curvature, and straightness. The temperature of heated areas, as measured by approved methods, shall not exceed 1,100°F (593°C) for A514/A514M and A852/A852M steel nor 1,200°F (649°C) for other steels.

##### 2. Thermal Cutting

Thermally cut edges shall meet the requirements of AWS 5.15.1.2, 5.15.4.3 and 5.15.4.4 with the exception that thermally cut free edges which will be subject to calculated static tensile stress shall be free of round bottom gouges greater than  $\frac{3}{16}$ -in. (5 mm) deep and sharp V-shaped notches. Gouges greater than  $\frac{3}{16}$ -in. (5 mm) deep and notches shall be removed by grinding or repaired by welding.

Re-entrant corners, except re-entrant corners of beam copes and weld access holes, shall meet the requirements of AWS 5.16. If another specified contour is required it must be shown on the contract documents.

Beam copes and weld access holes shall meet the geometrical requirements of Section J1.6. For beam copes and weld access holes in ASTM A6/A6M Group 4 and 5 shapes and welded built-up shapes with material thickness greater than two in. (50 mm), a preheat temperature of not less than 150°F (66°C) shall be applied prior to thermal cutting.

##### 3. Planing of Edges

Planing or finishing of sheared or thermally cut edges of plates or shapes is not

required unless specifically called for in the design documents or included in a stipulated edge preparation for welding.

#### **4. Welded Construction**

The technique of welding, the workmanship, appearance, and quality of welds and the methods used in correcting nonconforming work shall be in accordance with AWS D1.1 except as modified in Section J2.

#### **5. Bolted Construction**

All parts of bolted members shall be pinned or bolted and rigidly held together during assembly. Use of a drift pin in bolt holes during assembly shall not distort the metal or enlarge the holes. Poor matching of holes shall be cause for rejection.

If the thickness of the material is not greater than the nominal diameter of the bolt plus  $\frac{1}{8}$ -in. (3 mm), the holes are permitted to be punched. If the thickness of the material is greater than the nominal diameter of the bolt plus  $\frac{1}{8}$ -in. (3 mm), the holes shall be either drilled or sub-punched and reamed. The die for all sub-punched holes, and the drill for all sub-drilled holes, shall be at least  $\frac{1}{16}$ -in. (2 mm) smaller than the nominal diameter of the bolt. Holes in ASTM A514/A514M steel plates over  $\frac{1}{2}$ -in. (13 mm) thick shall be drilled.

Fully-inserted finger shims, with a total thickness of not more than  $\frac{1}{4}$ -in. (6 mm) within a joint, are permitted in joints without changing the design strength (based upon hole type) for the design of connections. The orientation of such shims is independent of the direction of application of the load.

The use of high-strength bolts shall conform to the requirements of the RCSC *Load and Resistance Factor Design Specification for Structural Joints Using ASTM A325 or A490 Bolts*.

#### **6. Compression Joints**

Compression joints which depend on contact bearing as part of the splice strength shall have the bearing surfaces of individual fabricated pieces prepared by milling, sawing, or other suitable means.

#### **7. Dimensional Tolerances**

Dimensional tolerances shall be in accordance with the AISC *Code of Standard Practice*.

#### **8. Finish of Column Bases**

Column bases and base plates shall be finished in accordance with the following requirements:

- (1) Steel bearing plates two in. (50 mm) or less in thickness are permitted without milling, provided a satisfactory contact bearing is obtained. Steel bearing plates over two in. (50 mm) but not over four in. (100 mm) in thickness are permitted to be straightened by pressing or, if presses are not available, by milling for all bearing surfaces (except as noted in subparagraphs 2 and 3 of this section), to obtain a satisfactory contact bearing. Steel bearing plates over four in. (100 mm) in thickness shall be milled for all bearing surfaces (except as noted in subparagraphs 2 and 3 of this section).

- (2) Bottom surfaces of bearing plates and column bases which are grouted to ensure full bearing contact on foundations need not be milled.
- (3) Top surfaces of bearing plates need not be milled when complete-joint-penetration groove welds are provided between the column and the bearing plate.

### **M3. SHOP PAINTING**

#### **1. General Requirements**

Shop painting and surface preparation shall be in accordance with the provisions of the *AISC Code of Standard Practice*.

Shop paint is not required unless specified by the contract documents.

#### **2. Inaccessible Surfaces**

Except for contact surfaces, surfaces inaccessible after shop assembly shall be cleaned and painted prior to assembly, if required by the design documents.

#### **3. Contact Surfaces**

Paint is permitted unconditionally in bearing-type connections. For slip-critical connections, the faying surface requirements shall be in accordance with the *RCSC Specification for Structural Joints Using ASTM A325 or A490 Bolts*, paragraph 3(b).

#### **4. Finished Surfaces**

Machine-finished surfaces shall be protected against corrosion by a rust inhibitive coating that can be removed prior to erection, or which has characteristics that make removal prior to erection unnecessary.

#### **5. Surfaces Adjacent to Field Welds**

Unless otherwise specified in the design documents, surfaces within two in. (50 mm) of any field weld location shall be free of materials that would prevent proper welding or produce objectionable fumes during welding.

### **M4. ERECTION**

#### **1. Alignment of Column Bases**

Column bases shall be set level and to correct elevation with full bearing on concrete or masonry.

#### **2. Bracing**

The frame of steel skeleton buildings shall be carried up true and plumb within the limits defined in the *AISC Code of Standard Practice*. Temporary bracing shall be provided, in accordance with the requirements of the *Code of Standard Practice*, wherever necessary to support all loads to which the structure may be subjected, including equipment and the operation of same. Such bracing shall be left in place as long as required for safety.

### 3. Alignment

No permanent bolting or welding shall be performed until the adjacent affected portions of the structure have been properly aligned.

### 4. Fit of Column Compression Joints and Base Plates

Lack of contact bearing not exceeding a gap of  $\frac{1}{16}$ -in. (2 mm), regardless of the type of splice used (partial-joint-penetration groove welded, or bolted), is permitted. If the gap exceeds  $\frac{1}{16}$ -in. (2 mm), but is less than  $\frac{1}{4}$ -in. (6 mm), and if an engineering investigation shows that sufficient contact area does not exist, the gap shall be packed out with non-tapered steel shims. Shims need not be other than mild steel, regardless of the grade of the main material.

### 5. Field Welding

Shop paint on surfaces adjacent to joints to be field welded shall be wire brushed if necessary to assure weld quality.

Field welding of attachments to installed embedments in contact with concrete shall be done in such a manner as to avoid excessive thermal expansion of the embedment which could result in spalling or cracking of the concrete or excessive stress in the embedment anchors.

### 6. Field Painting

Responsibility for touch-up painting, cleaning, and field painting shall be allocated in accordance with accepted local practices, and this allocation shall be set forth explicitly in the design documents.

### 7. Field Connections

As erection progresses, the structure shall be securely bolted or welded to support all dead, wind, and erection loads.

## M5. QUALITY CONTROL

The fabricator shall provide quality control procedures to the extent that the fabricator deems necessary to assure that all work is performed in accordance with this Specification. In addition to the fabricator's quality control procedures, material and workmanship at all times may be subject to inspection by qualified inspectors representing the purchaser. If such inspection by representatives of the purchaser will be required, it shall be so stated in the design documents.

### 1. Cooperation

As far as possible, all inspection by representatives of the purchaser shall be made at the fabricator's plant. The fabricator shall cooperate with the inspector, permitting access for inspection to all places where work is being done. The purchaser's inspector shall schedule this work for minimum interruption to the work of the fabricator.

### 2. Rejections

Material or workmanship not in reasonable conformance with the provisions of this Specification may be rejected at any time during the progress of the work.

The fabricator shall receive copies of all reports furnished to the purchaser by the inspection agency.

### **3. Inspection of Welding**

The inspection of welding shall be performed in accordance with the provisions of AWS D1.1 except as modified in Section J2.

When visual inspection is required to be performed by AWS certified welding inspectors, it shall be so specified in the design documents.

When nondestructive testing is required, the process, extent, and standards of acceptance shall be clearly defined in the design documents.

### **4. Inspection of Slip-Critical High-Strength Bolted Connections**

The inspection of slip-critical high-strength bolted connections shall be in accordance with the provisions of the *RCSC Load and Resistance Factor Design Specification for Structural Joints Using ASTM A325 or A490 Bolts*.

### **5. Identification of Steel**

The fabricator shall be able to demonstrate by a written procedure and by actual practice a method of material application and identification, visible at least through the “fit-up” operation, of the main structural elements of a shipping piece.

The identification method shall be capable of verifying proper material application as it relates to:

- (1) Material specification designation
- (2) Heat number, if required
- (3) Material test reports for special requirements

# CHAPTER N

## EVALUATION OF EXISTING STRUCTURES

This chapter applies to the evaluation of the strength and stiffness under static vertical (gravity) loads of existing structures by structural analysis, by load tests, or by a combination of structural analysis and load tests when specified by the Engineer of Record or in the contract documents. For such evaluation, the steel grades are not limited to those listed in Section A3.1. This chapter does not address load testing for the effects of seismic loads or moving loads (vibrations).

### **N1. GENERAL PROVISIONS**

These provisions shall be applicable when the evaluation of an existing steel structure is specified for (a) verification of a specific set of design loadings or (b) determination of the design strength of a load resisting member or system. The evaluation shall be performed by structural analysis (Section N3), by load tests (Section N4), or by a combination of structural analysis and load tests, as specified in the contract documents. Where load tests are used, the Engineer of Record shall first analyze the structure, prepare a testing plan, and develop a written procedure to prevent excessive permanent deformation or catastrophic collapse during testing.

### **N2. MATERIAL PROPERTIES**

#### **1. Determination of Required Tests**

The Engineer of Record shall determine the specific tests that are required from Section N2.2 through N2.6 and specify the locations where they are required. Where available, the use of applicable project records shall be permitted to reduce or eliminate the need for testing.

#### **2. Tensile Properties**

Tensile properties of members shall be considered in evaluation by structural analysis (Section N3) or load tests (Section N4). Such properties shall include the yield stress, tensile strength, and percent elongation. Where available, certified mill test reports or certified reports of tests made by the fabricator or a testing laboratory in accordance with ASTM A6/A6M or A568/A568M, as applicable, shall be permitted for this purpose. Otherwise, tensile tests shall be conducted in accordance with ASTM A370 from samples cut from components of the structure.

#### **3. Chemical Composition**

Where welding is anticipated for repair or modification of existing structures, the chemical composition of the steel shall be determined for use in preparing a welding procedure specification (WPS). Where available, results from certified mill test reports or certified reports of tests made by the fabricator or a testing laboratory in

accordance with ASTM procedures shall be permitted for this purpose. Otherwise, analyses shall be conducted in accordance with ASTM A751 from the samples used to determine tensile properties, or from samples taken from the same locations.

#### **4. Base Metal Notch Toughness**

Where welded tension splices in heavy shapes and plates as defined in Section A3.1c are critical to the performance of the structure, the Charpy V-notch toughness shall be determined in accordance with the provisions of Section A3.1c. If the notch toughness so determined does not meet the provisions of Section A3.1c, the Engineer of Record shall determine if remedial actions are required.

#### **5. Weld Metal**

Where structural performance is dependent on existing welded connections, representative samples of weld metal shall be obtained. Chemical analysis and mechanical tests shall be made to characterize the weld metal. A determination shall be made of the magnitude and consequences of imperfections. If the requirements of AWS D1.1 are not met, the Engineer of Record shall determine if remedial actions are required.

#### **6. Bolts and Rivets**

Representative samples of bolts shall be inspected to determine markings and classifications. Where bolts can not be properly identified visually, representative samples shall be removed and tested to determine tensile strength in accordance with ASTM F606 or ASTM F606M and the bolt classified accordingly. Alternatively, the assumption that the bolts are A307 shall be permitted. Rivets shall be assumed to be A502, Grade 1, unless a higher grade is established through documentation or testing.

### **N3. EVALUATION BY STRUCTURAL ANALYSIS**

#### **1. Dimensional Data**

All dimensions used in the evaluation, such as spans, column heights, member spacings, bracing locations, cross section dimensions, thicknesses, and connection details, shall be determined from a field survey. Alternatively, when available, it shall be permitted to determine such dimensions from applicable project design or shop drawings with field verification of critical values.

#### **2. Strength Evaluation**

Forces (load effects) in members and connections shall be determined by structural analysis applicable to the type of structure evaluated. The load effects shall be determined for the loads and factored load combinations stipulated in Section A4.

The design strength of members and connections shall be determined from applicable provisions of Chapters B through K of this Specification.

#### **3. Serviceability Evaluation**

Where required, the deformations at service loads shall be calculated and reported.



## **N4. EVALUATION BY LOAD TESTS**

### **1. Determination of Live Load Rating by Testing**

To determine the live load rating of an existing floor or roof structure by testing, a test load shall be applied incrementally in accordance with the Engineer of Record's plan. The structure shall be visually inspected for signs of distress or imminent failure at each load level. Appropriate measures shall be taken if these or any other unusual conditions are encountered.

The tested design strength of the structure shall be taken as the maximum applied test load plus the in-situ dead load. The live load rating of a floor structure shall be determined by setting the tested design strength equal to  $1.2D + 1.6L$ , where  $D$  is the nominal dead load and  $L$  is the nominal live load rating for the structure. The nominal live load rating of the floor structure shall not exceed that which can be calculated using applicable provisions of the specification. For roof structures,  $L_r$ ,  $S$ , or  $R$  as defined in the Symbols, shall be substituted for  $L$ . More severe load combinations shall be used where required by applicable building codes.

Periodic unloading shall be considered once the service load level is attained and after the onset of inelastic structural behavior is identified to document the amount of permanent set and the magnitude of the inelastic deformations. Deformations of the structure, such as member deflections, shall be monitored at critical locations during the test, referenced to the initial position before loading. It shall be demonstrated, while maintaining maximum test load for one hour, that the deformation of the structure does not increase by more than 10 percent above that at the beginning of the holding period. It is permissible to repeat the sequence if necessary to demonstrate compliance.

Deformations of the structure shall also be recorded 24 hours after the test loading is removed to determine the amount of permanent set. Because the amount of acceptable permanent deformation depends on the specific structure, no limit is specified for permanent deformation at maximum loading. Where it is not feasible to load test the entire structure, a segment or zone of not less than one complete bay, representative of the most critical conditions, shall be selected.

### **2. Serviceability Evaluation**

When load tests are prescribed, the structure shall be loaded incrementally to the service load level. Deformations shall be monitored for a period of one hour. The structure shall then be unloaded and the deformation recorded.

## **N5. EVALUATION REPORT**

After the evaluation of an existing structure has been completed, the Engineer of Record shall prepare a report documenting the evaluation. The report shall indicate whether the evaluation was performed by structural analysis, by load testing or by a combination of structural analysis and load testing. Furthermore, when testing is performed, the report shall include the loads and load combination used and the load-deformation and time-deformation relationships observed. All relevant information obtained from design drawing, mill test reports, and auxiliary material testing shall also be reported. Finally, the report shall indicate whether the design strength of the structure, including all members and connections, is adequate to withstand the load effects.

## APPENDIX B

### DESIGN REQUIREMENTS

Appendix B5.1 provides an expanded definition of limiting width-thickness ratio for webs in combined flexure and axial compression. Appendix B5.3 applies to the design of members containing slender compression elements.

#### B5. LOCAL BUCKLING

##### 1. Classification of Steel Sections

For members with unequal flanges and with webs in combined flexural and axial compression,  $\lambda_r$  for the limit state of web local buckling is

$$\lambda_r = 1.49 \sqrt{\frac{E}{F_y}} \left[ 1 + 2.83 \left( \frac{h}{h_c} \right) \left( 1 - \frac{P_u}{\phi_b P_y} \right) \right] \quad (\text{A-B5-1})$$

$$\frac{3}{4} \leq \frac{h}{h_c} \leq \frac{3}{2}$$

For members with unequal flanges with webs subjected to flexure only,  $\lambda_r$  for the limit state of web local buckling is

$$\lambda_r = 1.49 \sqrt{\frac{E}{F_y}} \left[ 1 + 2.83 \left( \frac{h}{h_c} \right) \right] \quad (\text{A-B5-2})$$

$$\frac{3}{4} \leq \frac{h}{h_c} \leq \frac{3}{2}$$

where  $\lambda_r$ ,  $h$ , and  $h_c$  are as defined in Section B5.1.

These substitutions shall be made in Appendices F and G when applied to members with unequal flanges. If the compression flange is larger than the tension flange,  $\lambda_r$  shall be determined using Equation A-B5-1, A-B5-2, or Table B5.1.

##### 3. Slender-Element Compression Sections

Axially loaded members containing elements subject to compression which have a width-thickness ratio in excess of the applicable  $\lambda_r$  as stipulated in Section B5.1 shall be proportioned according to this Appendix. Flexural members with slender compression elements shall be designed in accordance with Appendices F and G. Flexural members with proportions not covered by Appendix F1 shall be designed in accordance with this Appendix.

### 3a. Unstiffened Compression Elements

The design strength of unstiffened compression elements whose width-thickness ratio exceeds the applicable limit  $\lambda_r$ , as stipulated in Section B5.1 shall be subject to a reduction factor  $Q_s$ . The value of  $Q_s$  shall be determined by Equations A-B5-3 through A-B5-10, as applicable. When such elements comprise the compression flange of a flexural member, the design flexural strength, in ksi, shall be computed using  $\phi_b F_y Q_s$ , where  $\phi_b = 0.90$ . The design strength of axially loaded compression members shall be modified by the appropriate reduction factor  $Q$ , as provided in Appendix B5.3d.

(a) For single angles:

when  $0.45\sqrt{E/F_y} < b/t < 0.91\sqrt{E/F_y}$  :

$$Q_s = 1.340 - 0.76(b/t)\sqrt{F_y/E} \quad (\text{A-B5-3})$$

when  $b/t > 0.91\sqrt{E/F_y}$  :

$$Q_s = 0.53E / \left[ F_y (b/t)^2 \right] \quad (\text{A-B5-4})$$

(b) For flanges, angles, and plates projecting from rolled beams or columns or other compression members:

when  $0.56\sqrt{E/F_y} < b/t < 1.03\sqrt{E/F_y}$  :

$$Q_s = 1.415 - 0.74(b/t)\sqrt{F_y/E} \quad (\text{A-B5-5})$$

when  $b/t \geq 1.03\sqrt{E/F_y}$  :

$$Q_s = 0.69E / \left[ F_y (b/t)^2 \right] \quad (\text{A-B5-6})$$

(c) For flanges, angles and plates projecting from built-up columns or other compression members:

when  $0.64\sqrt{E/(F_y/k_c)} < b/t < 1.17\sqrt{E/(F_y/k_c)}$  :

$$Q_s = 1.415 - 0.65(b/t)\sqrt{(F_y/k_c)E} \quad (\text{A-B5-7})$$

when  $b/t \geq 1.17\sqrt{E/(F_y/k_c)}$  :

$$Q_s = 0.90Ek_c / \left[ F_y (b/t)^2 \right] \quad (\text{A-B5-8})$$

The coefficient,  $k_c$ , shall be computed as follows:

(a) For I-shaped sections:

$$k_c = \frac{4}{\sqrt{h/t_w}}, 0.35 \leq k_c \leq 0.763$$

where

$$h = \text{depth of web, in. (mm)}$$

$$t_w = \text{thickness of web, in. (mm)}$$

(b) For other sections:

$$k_c = 0.763$$

(d) For stems of tees:

when  $0.75\sqrt{E/F_y} < b/t < 1.03\sqrt{E/F_y}$  :

$$Q_s = 1.908 - 1.22(b/t)\sqrt{F_y/E} \quad (\text{A-B5-9})$$

when  $b/t \geq 1.03\sqrt{E/F_y}$  :

$$Q_s = 0.69E/[F_y(b/t)^2] \quad (\text{A-B5-10})$$

where

$$b = \text{width of unstiffened compression element as defined in Section B5.1, in. (mm)}$$

$$t = \text{thickness of unstiffened element, in. (mm)}$$

### 3b. Stiffened Compression Elements

When the width-thickness ratio of uniformly compressed stiffened elements (except perforated cover plates) exceeds the limit  $\lambda_r$  stipulated in Section B5.1, a reduced effective width  $b_e$  shall be used in computing the design properties of the section containing the element.

(a) For flanges of square and rectangular sections of uniform thickness:

when  $\frac{b}{t} \geq 1.40\sqrt{\frac{E}{f}}$  :

$$b_e = 1.91t\sqrt{\frac{E}{f}} \left[ 1 - \frac{0.38}{(b/t)}\sqrt{\frac{E}{f}} \right] \quad (\text{A-B5-11})$$

otherwise  $b_e = b$ .

(b) For other uniformly compressed elements:

when  $\frac{b}{t} \geq 1.49\sqrt{\frac{E}{f}}$  :

$$b_e = 1.91t\sqrt{\frac{E}{f}} \left[ 1 - \frac{0.34}{(b/t)}\sqrt{\frac{E}{f}} \right] \quad (\text{A-B5-12})$$

otherwise  $b_e = b$ .

where

$b$  = actual width of a stiffened compression element, as defined in Section B5.1, in. (mm)

$b_e$  = reduced effective width, in. (mm)

$t$  = element thickness, in. (mm)

$f$  = computed elastic compressive stress in the stiffened elements, based on the design properties as specified in Appendix B5.3c, ksi (MPa). If unstiffened elements are included in the total cross section,  $f$  for the stiffened element must be such that the maximum compressive stress in the unstiffened element does not exceed  $\phi_c F_{cr}$  as defined in Appendix B5.3d with  $Q = Q_s$  and  $\phi_c = 0.85$ , or  $\phi_b F_y / Q_s$  with  $\phi_b = 0.90$ , as applicable.

- (c) For axially loaded circular sections with diameter-to-thickness ratio  $D / t$  greater than  $0.11E/F_y$  but less than  $0.45E / F_y$

$$Q = Q_a = \frac{0.038E}{F_y(D/t)} + \frac{2}{3} \quad (\text{A-B5-13})$$

where

$D$  = outside diameter, in. (mm)

$t$  = wall thickness, in. (mm)

### 3c. Design Properties

Properties of sections shall be determined using the full cross section, except as follows:

In computing the moment of inertia and elastic section modulus of flexural members, the effective width of uniformly compressed stiffened elements  $b_e$ , as determined in Appendix B5.3b, shall be used in determining effective cross-sectional properties.

For unstiffened elements of the cross section,  $Q_s$  is determined from Appendix B5.3a. For stiffened elements of the cross section

$$Q_a = \frac{\text{effective area}}{\text{actual area}} \quad (\text{A-B5-14})$$

where the effective area is equal to the summation of the effective areas of the cross section.

### 3d. Design Strength

For axially loaded compression members the gross cross-sectional area and the radius of gyration  $r$  shall be computed on the basis of the actual cross section. The critical stress  $F_{cr}$  shall be determined as follows:

- (a) For  $\lambda_c \sqrt{\bar{Q}} \leq 1.5$ :

$$F_{cr} = Q(0.658^{Q\lambda_c^2})F_y \quad (\text{A-B5-15})$$

- (b) For  $\lambda_c \sqrt{\bar{Q}} > 1.5$ :

$$F_{cr} = \left[ \frac{0.877}{\lambda_c^2} \right] F_y \quad (\text{A-B5-16})$$

where

$$Q = Q_s Q_a \quad (\text{A-B5-17})$$

Cross sections comprised of only unstiffened elements,  $Q = Q_s$ , ( $Q_a = 1.0$ )

Cross sections comprised of only stiffened elements,  $Q = Q_a$ , ( $Q_s = 1.0$ )

Cross sections comprised of both stiffened and unstiffened elements,  $Q = Q_s Q_a$

## APPENDIX E

### COLUMNS AND OTHER COMPRESSION MEMBERS

This Appendix applies to the strength of doubly symmetric columns with thin plate elements, and singly symmetric and unsymmetric columns for the limit states of flexural-torsional and torsional buckling.

#### E3. DESIGN COMPRESSIVE STRENGTH FOR FLEXURAL-TORSIONAL BUCKLING

The design strength of compression members determined by the limit states of torsional and flexural-torsional buckling is  $\phi_c P_n$ ,

where

$$\begin{aligned} \phi_c &= 0.85 \\ P_n &= \text{nominal resistance in compression, kips (N)} \\ &= A_g F_{cr} \end{aligned} \tag{A-E3-1}$$

$A_g$  = gross area of cross section, in.<sup>2</sup> (mm<sup>2</sup>)

The nominal critical stress  $F_{cr}$  is determined as follows:

(a) For  $\lambda_e \sqrt{Q} \leq 1.5$ :

$$F_{cr} = Q(0.658^{Q\lambda_e^2})F_y \tag{A-E3-2}$$

(b) For  $\lambda_e \sqrt{Q} > 1.5$ :

$$F_{cr} = \left[ \frac{0.877}{\lambda_e^2} \right] F_y \tag{A-E3-3}$$

where

$$\lambda_e = \sqrt{F_y / F_e} \tag{A-E3-4}$$

$Q = 1.0$  for elements meeting the width-thickness ratios  $\lambda_r$  of Section B5.1  
 $= Q_s Q_a$  for elements not meeting the width-thickness ratios  $\lambda_r$  of Section B5.1  
 and determined in accordance with the provisions of Appendix B5.3

The critical torsional or flexural-torsional elastic buckling stress  $F_e$  is determined as follows:

(a) For doubly symmetric shapes:

$$F_e = \left[ \frac{\pi^2 EC_w}{(K_z l)^2} + GJ \right] \frac{1}{I_x + I_y} \quad (\text{A-E3-5})$$

(b) For singly symmetric shapes where  $y$  is the axis of symmetry:

$$F_e = \frac{F_{ey} + F_{ez}}{2H} \left( 1 - \sqrt{1 - \frac{4F_{ey}F_{ez}H}{(F_{ey} + F_{ez})^2}} \right) \quad (\text{A-E3-6})$$

(c) For unsymmetric shapes, the critical flexural-torsional elastic buckling stress  $F_e$  is the lowest root of the cubic equation

$$(F_e - F_{ex})(F_e - F_{ey})(F_e - F_{ez}) - F_e^2(F_e - F_{ey}) \left( \frac{x_o}{\bar{r}_o} \right)^2 - F_e^2(F_e - F_{ex}) \left( \frac{y_o}{\bar{r}_o} \right)^2 = 0 \quad (\text{A-E3-7})$$

where

$K_z$  = effective length factor for torsional buckling

$G$  = shear modulus, ksi (MPa)

$C_w$  = warping constant, in.<sup>6</sup> (mm<sup>6</sup>)

$J$  = torsional constant, in.<sup>4</sup> (mm<sup>4</sup>)

$I_x, I_y$  = moment of inertia about the principal axes, in.<sup>4</sup> (mm<sup>4</sup>)

$x_o, y_o$  = coordinates of shear center with respect to the centroid, in. (mm)

$$\bar{r}_o^2 = x_o^2 + y_o^2 + \frac{I_x + I_y}{A} \quad (\text{A-E3-8})$$

$$H = 1 - \left( \frac{x_o^2 + y_o^2}{\bar{r}_o^2} \right) \quad (\text{A-E3-9})$$

$$F_{ex} = \frac{\pi^2 E}{(K_x l / r_x)^2} \quad (\text{A-E3-10})$$

$$F_{ey} = \frac{\pi^2 E}{(K_y l / r_y)^2} \quad (\text{A-E3-11})$$

$$F_{ez} = \left( \frac{\pi^2 EC_w}{(K_z l)^2} + GJ \right) \frac{1}{A\bar{r}_o^2} \quad (\text{A-E3-12})$$

$A$  = cross-sectional area of member, in.<sup>2</sup> (mm<sup>2</sup>)

$l$  = unbraced length, in. (mm)

$K_x, K_y$  = effective length factors in  $x$  and  $y$  directions

$r_x, r_y$  = radii of gyration about the principal axes, in. (mm)

$\bar{r}_o$  = polar radius of gyration about the shear center, in. (mm)



## APPENDIX F

### BEAMS AND OTHER FLEXURAL MEMBERS

Appendix F1 provides the design flexural strength of beams and other flexural members. Appendix F2 provides the design shear strength of webs with and without stiffeners and requirements on transverse stiffeners. Appendix F3 applies to web-tapered members.

#### F1. DESIGN FOR FLEXURE

The design strength for flexural members is  $\phi_b M_n$  where  $\phi_b = 0.90$  and  $M_n$  is the nominal strength.

Table A-F1.1 provides a tabular summary of Equations F1-1 through F1-15 for determining the nominal flexural strength of beams and other flexural members. For slenderness parameters of cross sections not included in Table A-F1.1, see Appendix B5.3. For flexural members with unequal flanges see Appendix B5.1 for the determination of  $\lambda_r$  for the limit state of web local buckling.

The nominal flexural strength  $M_n$  is the lowest value obtained according to the limit states of yielding; lateral-torsional buckling (LTB); flange local buckling (FLB); and web local buckling (WLB).

The nominal flexural strength  $M_n$  shall be determined as follows for each limit state:

(a) For  $\lambda \leq \lambda_p$ :

$$M_n = M_p \quad (\text{A-F1-1})$$

(b) For  $\lambda_p < \lambda \leq \lambda_r$ :

For the limit state of lateral-torsional buckling:

$$M_n = C_b \left[ M_p - (M_p - M_r) \left( \frac{\lambda - \lambda_p}{\lambda_r - \lambda_p} \right) \right] \leq M_p \quad (\text{A-F1-2})$$

For the limit states of flange and web local buckling:

$$M_n = M_p - (M_p - M_r) \left( \frac{\lambda - \lambda_p}{\lambda_r - \lambda_p} \right) \quad (\text{A-F1-3})$$

(c) For  $\lambda > \lambda_r$ :

For the limit state of lateral-torsional buckling and flange local buckling:

$$M_n = M_{cr} = SF_{cr} \leq M_p \quad (\text{A-F1-4})$$

For the design of other flexural members with slender webs, the limit state of web local buckling is not applicable. See Appendix G2.

For  $\lambda$  of the flange  $> \lambda_r$  in shapes not included in Table A-F1.1, see Appendix B5.3.

For  $\lambda$  of the web  $> \lambda_r$ , see Appendix G.

The terms used in the above equations are:

$M_n$  = nominal flexural strength, kip-in. (N-mm)

$M_p = F_y Z$ , plastic moment  $\leq 1.5 F_y S$ , kip-in. (N-mm)

$M_{cr}$  = buckling moment, kip-in. (N-mm)

$M_r$  = limiting buckling moment (equal to  $M_{cr}$  when  $\lambda = \lambda_r$ ), kip-in. (N-mm)

$\lambda$  = controlling slenderness parameter

= minor axis slenderness ratio  $L_b / r_y$  for lateral-torsional buckling

= flange width-thickness ratio  $b/t$  for flange local buckling as defined in Section B5.1

= web depth-thickness ratio  $h/t_w$  for web local buckling as defined in Section B5.1

$\lambda_p$  = largest value of  $\lambda$  for which  $M_n = M_p$

$\lambda_r$  = largest value of  $\lambda$  for which buckling is inelastic

$F_{cr}$  = critical stress, ksi (MPa)

$C_b$  = bending coefficient dependent on moment gradient, see Section F1.2a, Equation F1-3

$S$  = section modulus, in.<sup>3</sup> (mm<sup>3</sup>)

$L_b$  = laterally unbraced length, in. (mm)

$r_y$  = radius of gyration about minor axis, in. (mm)

The applicable limit states and equations for  $M_p$ ,  $M_r$ ,  $F_{cr}$ ,  $\lambda$ ,  $\lambda_p$ , and  $\lambda_r$  are given in the Table A-F1.1 for shapes covered in this Appendix. The terms used in the table are:

$A$  = cross-sectional area, in.<sup>2</sup> (mm<sup>2</sup>)

$F_L$  = smaller of  $(F_{yf} - F_r)$  or  $F_{yw}$ , ksi (MPa)

$F_r$  = compressive residual stress in flange

= 10 ksi (69 N/mm<sup>2</sup>) for rolled shapes

= 16.5 ksi (114 N/mm<sup>2</sup>) for welded shapes

$F_y$  = specified minimum yield strength, ksi (MPa)

$F_{yf}$  = yield strength of the flange, ksi (MPa)

$F_{yw}$  = yield strength of the web, ksi (MPa)

$I_{yc}$  = moment of inertia of compression flange about y axis or if reverse curvature bending, moment of inertia of smaller flange, in.<sup>4</sup> (mm<sup>4</sup>)

$J$  = torsional constant, in.<sup>4</sup> (mm<sup>4</sup>)

$R_e$  = see Appendix G2

$S_{eff}$  = effective section modulus about major axis, in.<sup>3</sup> (mm<sup>3</sup>)

$S_{xc}$  = section modulus of the outside fiber of the compression flange, in.<sup>3</sup> (mm<sup>3</sup>)

$S_{xt}$  = section modulus of the outside fiber of the tension flange, in.<sup>3</sup> (mm<sup>3</sup>)

$Z$  = plastic section modulus, in.<sup>3</sup> (mm<sup>3</sup>)

$b$  = flange width, in. (mm)

$d$  = overall depth, in. (mm)

$f$  = computed compressive stress in the stiffened element, ksi (MPa)

**TABLE A-F1.1  
Nominal Strength Parameters**

Shape	Plastic Moment $M_p$	Limit State of Buckling	Limiting Buckling Moment $M_r$
Channels and doubly and singly symmetric I-shaped beams (including hybrid beams) bent about major axis [a]	$F_y Z_x$ [b]	LTB doubly symmetric members and channels	$F_L S_x$
		LTB singly symmetric members	$F_L S_{xc} \leq F_{yt} S_{xt}$
		FLB	$F_L S_x$
		WLB	$R_e F_{yt} S_x$
Channels and doubly and singly symmetric I-shaped members bent about minor axis [a]	$F_y Z_y$	FLB	$F_y S_y$

NOTE: LTB applies only for strong axis bending.  
 [a] Excluding double angles and tees.  
 [b] Computed from fully plastic stress distribution for hybrid sections.

[c]  $X_1 = \frac{\pi}{S_x} \sqrt{\frac{EGJA}{2}} X_2 = 4 \frac{C_w}{I_y} \left( \frac{S_x}{GJ} \right)^2$

[d]  $\lambda_r = \frac{X_1}{F_L} \sqrt{1 + \sqrt{1 + X_2 F_L^2}}$

[e]  $F_{cr} = \frac{M_{cr}}{S_{xc}}$ , where  $M_{cr} = \frac{2EC_b}{L_b} \sqrt{I_y J} \left[ B_1 + \sqrt{1 + B_2 + B_1^2} \right] \leq M_p$

where

$B_1 = 2.25 \left[ 2(I_{yc}/I_y) - 1 \right] (h/L_b) \sqrt{(I_y/J)}$

$B_2 = 25(1 - I_{yc}/I_y) (I_{yc}/J) (h/L_b)^2$

$C_b = 1.0$  if  $I_{yc}/I_y < 0.1$  or  $I_{yc}/I_y > 0.9$

**TABLE A-F1.1 (cont'd)**  
**Nominal Strength Parameters**

Critical Stress $F_{cr}$	Slenderness Parameters			Limitations
	$\lambda$	$\lambda_p$	$\lambda_r$	
$\frac{C_b X_1 \sqrt{2}}{\lambda} \sqrt{1 + \frac{X_1^2 X_2}{2\lambda^2}}$	$\frac{L_b}{r_y}$	$1.76 \sqrt{\frac{E}{F_{yf}}}$	[c,d]	Applicable for I-shaped members if $h/t_w \leq \lambda_r$ . When $h/t_w > \lambda_r$ see Appendix G.
[e]	$\frac{L_b}{r_{yc}}$	$1.76 \sqrt{\frac{E}{F_{yf}}}$	Value of $\lambda$ for which $M_{cr}(C_b = 1) = M_r$	
[f]	$\frac{b}{t}$	$0.38 \sqrt{\frac{E}{F_{yf}}}$	[g]	
Not applicable	$\frac{h}{t_w}$	$3.76 \sqrt{\frac{E}{F_{yf}}}$	$\lambda_r$ as defined in Section B5.1	
$\frac{0.69E}{\lambda^2}$	$\frac{b}{t}$	$0.38 \sqrt{\frac{E}{F_{yf}}}$	$0.83 \sqrt{\frac{E}{F_L}}$	None

Notes (cont'd):

[f]  $F_{cr} = \frac{0.69E}{\lambda^2}$  for rolled shapes

$F_{cr} = \frac{0.90Ek_c}{\lambda^2}$  for welded shapes

where

$k_c = 4 / \sqrt{h/t_w}$  and  $0.35 \leq k_c \leq 0.763$

[g]  $\lambda_r = 0.83 \sqrt{\frac{E}{F_L}}$  for rolled shapes

$\lambda_r = 0.95 \sqrt{\frac{E}{(F_L / k_c)}}$  for welded shapes

**TABLE A-F1.1 (cont'd)**  
**Nominal Strength Parameters**

Shape	Plastic Moment $M_p$	Limit State of Buckling	Limiting Buckling Moment $M_r$
Solid symmetric shapes, except rectangular bars, bent about major axis	$F_y Z_x$	Not Applicable	
Solid rectangular bars bent about major axis	$F_y Z_x$	LTB	$F_y S_x$
Symmetric box sections loaded in a plane of symmetry	$F_y Z$	LTB	$F_{yt} S_{eff}$
		FLB	$F_y S_{eff}$
		WLB	Same as for I-shape
Round HSS	$F_y Z$	LTB	Not applicable
		FLB	$M_n = \left( \frac{0.021E}{D/t} + F_y \right) S$ [h]
		WLB	Not applicable
<p>Notes (cont'd): [h] This equation is to be used in place of Equation A-F1-3.</p>			

**TABLE A-F1.1 (cont'd)  
Nominal Strength Parameters**

Critical Stress $F_{cr}$	Slenderness Parameters			Limitations
	$\lambda$	$\lambda_p$	$\lambda_r$	
Not applicable				
$\frac{2EC_b\sqrt{JA}}{\lambda S_x}$	$\frac{L_b}{r_y}$	$\frac{0.13E\sqrt{JA}}{M_p}$	$\frac{2E\sqrt{JA}}{M_r}$	None
$\frac{2EC_b\sqrt{JA}}{\lambda S_x}$	$\frac{L_b}{r_y}$	$\frac{0.13E\sqrt{JA}}{M_p}$	$\frac{2E\sqrt{JA}}{M_r}$	Applicable if $h/t_w \leq 5.70\sqrt{E/F_{yt}}$
$\frac{S_{eff}}{S} F_y$ [i]	$\frac{b}{t}$	$1.12\sqrt{\frac{E}{F_y}}$	$1.40\sqrt{\frac{E}{F_y}}$	None
Same as for I-Shape				
Not applicable				
$\frac{0.33E}{D/t}$	$D/t$	$\frac{0.071E}{F_y}$	$\frac{0.31E}{F_y}$	$D/t < \frac{0.45E}{F_y}$
Not applicable				
Notes (cont'd): [i] $S_{eff}$ is the effective section modulus for the section with a compression flange $b_e$ defined in Appendix B5.3b.				

- $h$  = clear distance between flanges less the fillet or corner radius at each flange, in. (mm)  
 $r_{yc}$  = radius of gyration of compression flange about y axis or if reverse curvature bending, smaller flange, in. (mm)  
 $t_f$  = flange thickness, in. (mm)  
 $t_w$  = web thickness, in. (mm)

## F2. DESIGN FOR SHEAR

### 2. Design Shear Strength

The design shear strength of stiffened or unstiffened webs is  $\phi V_n$ ,

where

$$\phi_v = 0.90$$

$V_n$  = nominal shear strength defined as follows:

- (a) For  $h/t_w \leq 1.10\sqrt{k_v E / F_{yw}}$  :

$$V_n = 0.6F_{yw}A_w \quad (\text{A-F2-1})$$

- (b) For  $1.10\sqrt{k_v E / F_{yw}} < h/t_w \leq 1.37\sqrt{k_v E / F_{yw}}$  :

$$V_n = 0.6F_{yw}A_w(1.10\sqrt{k_v E / F_{yw}})/(h/t_w) \quad (\text{A-F2-2})$$

- (c) For  $h/t_w > 1.37\sqrt{k_v E / F_{yw}}$  :

$$V_n = A_w(0.91Ek_v)/(h/t_w)^2 \quad (\text{A-F2-3})$$

where

$$k_v = 5 + 5 / (a / h)^2$$

$$= 5 \text{ when } a / h > 3 \text{ or } a / h > [260 / (h / t)]^2$$

$a$  = distance between transverse stiffeners, in. (mm)

$h$  = for rolled shapes, the clear distance between flanges less the fillet or corner radius, in. (mm)

= for built-up welded sections, the clear distance between flanges, in. (mm)

= for built-up bolted or riveted sections, the distance between fastener lines, in. (mm)

### 3. Transverse Stiffeners

Transverse stiffeners are not required in plate girders where  $h/t_w \leq 2.45\sqrt{E/F_{yw}}$  or where the required shear,  $V_u$ , as determined by structural analysis for the factored loads, is less than or equal to  $0.6\phi_v A_w F_{yw} C_v$ , where  $\phi_v = 0.90$  and the shear coefficient  $C_v$  defined in Appendix G3 is determined for  $k_v = 5$ .

Transverse stiffeners used to develop the web design shear strength as provided in Appendix F2.2 shall have a moment of inertia about an axis in the web center for stiffener pairs, or about the face in contact with the web plate for single stiffeners, which shall not be less than  $at_w^3 j$ , where

$$j = 2.5 / (a/h)^2 - 2 \geq 0.5 \quad (\text{A-F2-4})$$

Intermediate stiffeners are permitted to be stopped short of the tension flange, provided bearing is not needed to transmit a concentrated load or reaction. The weld by which intermediate stiffeners are attached to the web shall be terminated not less than four times nor more than six times the web thickness from the near toe of the web-to-flange weld. When single stiffeners are used, they shall be attached to the compression flange, if it consists of a rectangular plate, to resist any uplift tendency due to torsion in the flange. When lateral bracing is attached to a stiffener, or a pair of stiffeners, these, in turn, shall be connected to the compression flange to transmit one percent of the total flange stress, unless the flange is composed only of angles.

Bolts connecting stiffeners to the girder web shall be spaced not more than 12 in. (300 mm) on center. If intermittent fillet welds are used, the clear distance between welds shall not be more than 16 times the web thickness nor more than 10 in. (250 mm).

### F3. WEB-TAPERED MEMBERS

The design of tapered members meeting the requirements of this section shall be governed by the provisions of Chapters D through H, except as modified by this Appendix.

#### 1. General Requirements

In order to qualify under this Specification, a tapered member shall meet the following requirements:

- (1) It shall possess at least one axis of symmetry, which shall be perpendicular to the plane of bending if moments are present.
- (2) The flanges shall be of equal and constant area.
- (3) The depth shall vary linearly as

$$d = d_o \left( 1 + \gamma \frac{z}{L} \right) \quad (\text{A-F3-1})$$

where

$\gamma = (d_L - d_o) / d_o \leq$  the smaller of  $0.268(L / d_o)$  or  $6.0$

$d_o =$  depth at smaller end of member, in. (mm)

$d_L =$  depth at larger end of member, in. (mm)

$z =$  distance from the smaller end of member, in. (mm)

$L =$  unbraced length of member measured between the center of gravity of the bracing members, in. (mm)

#### 2. Design Tensile Strength

The design strength of tapered tension members shall be determined in accordance with Section D1.

#### 3. Design Compressive Strength

The design strength of tapered compression members shall be determined in accor-



dance with Appendix E3, using an effective slenderness parameter  $\lambda_{eff}$  computed as follows:

$$\lambda_{eff} = \frac{S}{\pi} \sqrt{\frac{QF_y}{E}} \quad (\text{A-F3-2})$$

where

$S = KL/r_{oy}$  for weak axis buckling and  $K_\gamma L/r_{ox}$  for strong axis buckling

$K$  = effective length factor for a prismatic member

$K_\gamma$  = effective length factor for a tapered member as determined by a rational analysis

$r_{ox}$  = strong axis radius of gyration at the smaller end of a tapered member, in. (mm)

$r_{oy}$  = weak axis radius of gyration at the smaller end of a tapered member, in. (mm)

$F_y$  = specified minimum yield stress, ksi (MPa)

$Q$  = reduction factor

= 1.0 if all elements meet the limiting width-thickness ratios  $\lambda_r$  of Section B5.1  
 =  $Q_s Q_a$ , determined in accordance with Appendix B5.3, if any stiffened and/or unstiffened elements exceed the ratios  $\lambda_r$  of Section B5.1

$E$  = modulus of elasticity for steel, ksi (MPa)

The smallest area of the tapered member shall be used for  $A_g$  in Equation E2-1.

#### 4. Design Flexural Strength

The design flexural strength of tapered flexural members for the limit state of lateral-torsional buckling is  $\phi_b M_n$ , where  $\phi_b = 0.90$  and the nominal strength is

$$M_n = (5/3) S'_x F_{b\gamma} \quad (\text{A-F3-3})$$

where

$S'_x$  = the section modulus of the critical section of the unbraced beam length under consideration

$$F_{b\gamma} = \frac{2}{3} \left[ 1.0 - \frac{F_y}{6B\sqrt{F_{sy}^2 + F_{wy}^2}} \right] F_y \leq 0.60F_y \quad (\text{A-F3-4})$$

unless  $F_{b\gamma} \leq F_y / 3$ , in which case

$$F_{b\gamma} = B\sqrt{F_{sy}^2 + F_{wy}^2} \quad (\text{A-F3-5})$$

In the preceding equations,

$$F_{sy} = \frac{0.41E}{h_s L d_o / A_f} \quad (\text{A-F3-6})$$

$$F_{w\gamma} = \frac{5.9E}{(h_w L / r_{To})^2} \quad (\text{A-F3-7})$$

where

$$h_s = \text{factor equal to } 1.0 + 0.230\gamma\sqrt{Ld_o / A_f}$$

$$h_w = \text{factor equal to } 1.0 + 0.00385\gamma\sqrt{L / r_{To}}$$

$r_{To}$  = radius of gyration of a section at the smaller end, considering only the compression flange plus one-third of the compression web area, taken about an axis in the plane of the web, in. (mm)

$A_f$  = area of the compression flange, in.<sup>2</sup> (mm<sup>2</sup>)

and where  $B$  is determined as follows:

- (a) When the maximum moment  $M_2$  in three adjacent segments of approximately equal unbraced length is located within the central segment and  $M_1$  is the larger moment at one end of the three-segment portion of a member:

$$B = 1.0 + 0.37\left(1.0 + \frac{M_1}{M_2}\right) + 0.50\gamma\left(1.0 + \frac{M_1}{M_2}\right) \geq 1.0 \quad (\text{A-F3-8})$$

- (b) When the largest computed bending stress  $f_{b2}$  occurs at the larger end of two adjacent segments of approximately equal unbraced lengths and  $f_{b1}$  is the computed bending stress at the smaller end of the two-segment portion of a member:

$$B = 1.0 + 0.58\left(1.0 + \frac{f_{b1}}{f_{b2}}\right) - 0.70\gamma\left(1.0 + \frac{f_{b1}}{f_{b2}}\right) \geq 1.0 \quad (\text{A-F3-9})$$

- (c) When the largest computed bending stress  $f_{b2}$  occurs at the smaller end of two adjacent segments of approximately equal unbraced length and  $f_{b1}$  is the computed bending stress at the larger end of the two-segment portion of a member:

$$B = 1.0 + 0.55\left(1.0 + \frac{f_{b1}}{f_{b2}}\right) + 2.20\gamma\left(1.0 + \frac{f_{b1}}{f_{b2}}\right) \geq 1.0 \quad (\text{A-F3-10})$$

In the foregoing,  $\gamma = (d_L - d_o) / d_o$  is calculated for the unbraced length that contains the maximum computed bending stress.  $M_1 / M_2$  is considered as negative when producing single curvature. In the rare case where  $M_1 / M_2$  is positive, it is recommended that it be taken as zero.  $f_{b1} / f_{b2}$  is considered as negative when producing single curvature. If a point of contraflexure occurs in one of two adjacent unbraced segments,  $f_{b1} / f_{b2}$  is considered as positive. The ratio  $f_{b1} / f_{b2} \neq 0$ .

- (d) When the computed bending stress at the smaller end of a tapered member or segment thereof is equal to zero:

$$B = \frac{1.75}{1.0 + 0.25\sqrt{\gamma}} \quad (\text{A-F3-11})$$

where  $\gamma = (d_L - d_o) / d_o$  is calculated for the unbraced length adjacent to the point of zero bending stress.

## 5. Design Shear Strength

The design shear strength of tapered flexural members shall be determined in accordance with Section F2.

## 6. Combined Flexure and Axial Force

For tapered members with a single web taper subject to compression and bending about the major axis, Equation H1-1 applies, with the following modifications.  $P_n$  and  $P_{ex}$  shall be determined for the properties of the smaller end, using appropriate effective length factors.  $M_{nx}$ ,  $M_u$ , and  $M_{px}$  shall be determined for the larger end;  $M_{nx} = (5/3)S'_x F_{by}$ , where  $S'_x$  is the elastic section modulus of the larger end, and  $F_{by}$  is the design flexural stress of tapered members.  $C_{mx}$  is replaced by  $C'_m$ , determined as follows:

- (a) When the member is subjected to end moments which cause single curvature bending and approximately equal computed moments at the ends:

$$C'_m = 1.0 + 0.1 \left( \frac{P_u}{\phi_b P_{ex}} \right) + 0.3 \left( \frac{P_u}{\phi_b P_{ex}} \right)^2 \quad (\text{A-F3-12})$$

- (b) When the computed bending moment at the smaller end of the unbraced length is equal to zero:

$$C'_m = 1.0 - 0.9 \left( \frac{P_u}{\phi_b P_{ex}} \right) + 0.6 \left( \frac{P_u}{\phi_b P_{ex}} \right)^2 \quad (\text{A-F3-13})$$

When the effective slenderness parameter  $\lambda_{eff} \geq 1.5$  and combined stress is checked incrementally along the length, the actual area and the actual section modulus at the section under investigation is permitted to be used.

# APPENDIX G

## PLATE GIRDERS

This appendix applies to I-shaped plate girders with slender webs.

### G1. LIMITATIONS

Doubly and singly symmetric single-web non-hybrid and hybrid plate girders loaded in the plane of the web shall be proportioned according to the provisions of this Appendix or Section F2, provided that the following limits are satisfied:

- (a) For  $\frac{a}{h} \leq 1.5$ :

$$\frac{h}{t_w} \leq 11.7 \sqrt{\frac{E}{F_{yf}}} \quad (\text{A-G1-1})$$

- (b) For  $\frac{a}{h} > 1.5$ :

$$\frac{h}{t_w} \leq \frac{0.48E}{\sqrt{F_{yf}(F_{yf} + 16.5)}} \quad (\text{A-G1-2})$$

$$\left( \text{Metric: } \frac{h}{t_w} \leq \frac{0.48E}{\sqrt{F_{yf}(F_{yf} + 114)}} \right) \quad (\text{A-G1-2M})$$

where

- $a$  = clear distance between transverse stiffeners, in. (mm)
- $h$  = clear distance between flanges less the fillet or corner radius for rolled shapes; and for built-up sections, the distance between adjacent lines of fasteners or the clear distance between flanges when welds are used, in. (mm)
- $t_w$  = web thickness, in. (mm)
- $F_{yf}$  = specified minimum yield stress of a flange, ksi (MPa)

In unstiffened girders  $h/t_w$  shall not exceed 260.

### G2. DESIGN FLEXURAL STRENGTH

The design flexural strength for plate girders with slender webs shall be  $\phi_b M_n$ , where  $\phi_b = 0.90$  and  $M_n$  is the lower value obtained according to the limit states of tension-flange yield and compression-flange buckling. For girders with unequal flanges, see Appendix B5.1 for the determination of  $\lambda_r$  for the limit state of web local buckling.

- (a) For tension-flange yield:

$$M_n = S_{xt} R_e F_{yt} \quad (\text{A-G2-1})$$

(b) For compression-flange buckling:

$$M_n = S_{xc} R_{PG} R_e F_{cr} \quad (\text{A-G2-2})$$

where

$$R_{PG} = 1 - \frac{a_r}{1,200 + 300a_r} \left( \frac{h_c}{t_w} - 5.70 \sqrt{\frac{E}{F_{cr}}} \right) \leq 1.0 \quad (\text{A-G2-3})$$

$R_e$  = hybrid girder factor

$$= \frac{12 + a_r (3m - m^3)}{12 + 2a_r} \leq 1.0 \quad (\text{for non-hybrid girders, } R_e = 1.0)$$

$a_r$  = ratio of web area to compression flange area ( $\leq 10$ )

$m$  = ratio of web yield stress to flange yield stress or to  $F_{cr}$

$F_{cr}$  = critical compression flange stress, ksi (MPa)

$F_{yt}$  = yield stress of tension flange, ksi (MPa)

$S_{xc}$  = section modulus referred to compression flange, in.<sup>3</sup> (mm<sup>3</sup>)

$S_{xt}$  = section modulus referred to tension flange, in.<sup>3</sup> (mm<sup>3</sup>)

$h_c$  = twice the distance from the centroid to the nearest line of fasteners at the compression flange or the inside of the face of the compression flange when welds are used, in. (mm)

The critical stress  $F_{cr}$  to be used is dependent upon the slenderness parameters  $\lambda$ ,  $\lambda_p$ ,  $\lambda_r$ , and  $C_{PG}$  as follows:

(a) For  $\lambda \leq \lambda_p$ :

$$F_{cr} = F_{yf} \quad (\text{A-G2-4})$$

(b) For  $\lambda_p < \lambda \leq \lambda_r$ :

$$F_{cr} = C_b F_{yf} \left[ 1 - \frac{1}{2} \left( \frac{\lambda - \lambda_p}{\lambda_r - \lambda_p} \right) \right] \leq F_{yf} \quad (\text{A-G2-5})$$

(c) For  $\lambda > \lambda_r$ :

$$F_{cr} = \frac{C_{PG}}{\lambda^2} \quad (\text{A-G2-6})$$

In the foregoing, the slenderness parameter shall be determined for both the limit state of lateral-torsional buckling and the limit state of flange local buckling; the slenderness parameter which results in the lowest value of  $F_{cr}$  governs.

(a) For the limit state of lateral-torsional buckling:

$$\lambda = \frac{L_b}{r_T} \quad (\text{A-G2-7})$$

$$\lambda_p = 1.76 \sqrt{\frac{E}{F_{yf}}} \quad (\text{A-G2-8})$$

$$\lambda_r = 4.44 \sqrt{\frac{E}{F_{yf}}} \quad (\text{A-G2-9})$$

$$C_{PG} = 286,000C_b \quad (\text{A-G2-10})$$

$$(\text{Metric: } C_{PG} = 1\,970\,000C_b) \quad (\text{A-G2-10M})$$

where

$C_b$  = see Section F1.2, Equation F1-3

$r_T$  = radius of gyration of compression flange plus one-third of the compression portion of the web, in. (mm)

(b) For the limit state of flange local buckling:

$$\lambda = \frac{b_f}{2t_f} \quad (\text{A-G2-11})$$

$$\lambda_p = 0.38 \sqrt{\frac{E}{F_{yf}}} \quad (\text{A-G2-12})$$

$$\lambda_r = 1.35 \sqrt{\frac{E}{F_{yf}/k_c}} \quad (\text{A-G2-13})$$

$$C_{PG} = 26,200k_c \quad (\text{A-G2-14})$$

$$(\text{Metric: } C_{PG} = 180\,650K_c) \quad (\text{A-G2-14M})$$

$$C_b = 1.0$$

where  $k_c = 4/\sqrt{h/t_w}$  and  $0.35 \leq k_c \leq 0.763$ .

The limit state of flexural web local buckling is not applicable.

### G3. DESIGN SHEAR STRENGTH

The design shear strength with tension field action shall be  $\phi_v V_n$ , kips (kN),

where

$\phi_v = 0.90$  and  $V_n$  is determined as follows:

(a) For  $h/t_w \leq 1.10\sqrt{k_v E / F_{yw}}$  :

$$V_n = 0.6 F_{yw} A_w \quad (\text{A-G3-1})$$

(b) For  $h/t_w > 1.10\sqrt{k_v E / F_{yw}}$  :

$$V_n = 0.6F_{yw}A_w \left( C_v + \frac{1 - C_v}{1.15\sqrt{1 + (a/h)^2}} \right) \quad (\text{A-G3-2})$$

Also see Appendix G4 and G5.

Tension field action is not permitted for end-panels in non-hybrid plate girders, all panels in hybrid and web-tapered plate girders, and when  $a/h$  exceeds 3.0 or  $[260/(h/t_w)]$ . For these cases, the nominal strength is:

$$V_n = 0.6F_{yw}A_w C_v \quad (\text{A-G3-3})$$

The web plate buckling coefficient  $k_v$  is given as

$$k_v = 5 + \frac{5}{(a/h)^2} \quad (\text{A-G3-4})$$

except that  $k_v$  shall be taken as 5.0 if  $a/h$  exceeds 3.0 or  $[260/(h/t_w)]^2$ .

The shear coefficient  $C_v$  is determined as follows:

$$(a) \text{ For } 1.10\sqrt{\frac{k_v E}{F_{yw}}} \leq \frac{h}{t_w} \leq 1.37\sqrt{\frac{k_v E}{F_{yw}}} :$$

$$C_v = \frac{1.10\sqrt{k_v E / F_{yw}}}{h / t_w} \quad (\text{A-G3-5})$$

$$(b) \text{ For } \frac{h}{t_w} > 1.37\sqrt{\frac{k_v E}{F_{yw}}} :$$

$$C_v = \frac{1.51k_v E}{(h/t_w)^2 F_{yw}} \quad (\text{A-G3-6})$$

#### G4. TRANSVERSE STIFFENERS

Transverse stiffeners are not required in plate girders where  $h/t_w \leq 2.45\sqrt{E/F_{yw}}$ , or where the required shear  $V_u$ , as determined by structural analysis for the factored loads, is less than or equal to  $0.6\phi_v F_{yw} A_w C_v$ , where  $C_v$  is determined for  $k_v = 5$  and  $\phi_v = 0.90$ . Stiffeners may be required in certain portions of a plate girder to develop the required shear or to satisfy the limitations given in Appendix G1. Transverse stiffeners shall satisfy the requirements of Appendix F2.3.

When designing for tension field action, the stiffener area  $A_{st}$  shall not be less than

$$\frac{F_{yw}}{F_{yst}} \left[ 0.15Dht_w(1 - C_v) \frac{V_u}{\phi V_n} - 18t_w^2 \right] \geq 0 \quad (\text{A-G4-1})$$

where

- $F_{yst}$  = specified yield stress of the stiffener material, ksi (MPa)
- $D$  = 1 for stiffeners in pairs
- = 1.8 for single angle stiffeners
- = 2.4 for single plate stiffeners

$C_v$  and  $V_n$  are defined in Appendix G3, and  $V_u$  is the required shear at the location of the stiffener.

## G5. FLEXURE-SHEAR INTERACTION

For  $0.6\phi V_n \leq V_u \leq \phi V_n$  and  $0.75\phi M_n \leq M_u \leq \phi M_n$ , plate girders with webs designed for tension field action shall satisfy the additional flexure-shear interaction criterion:

$$\frac{M_u}{\phi M_n} + 0.625 \frac{V_u}{\phi V_n} \leq 1.375 \quad (\text{A-G5-1})$$

where

- $M_n$  = nominal flexural strength of plate girder from Appendix G2 or Section F1
- $\phi$  = 0.90
- $V_n$  = nominal shear strength from Appendix G3



## APPENDIX H

### MEMBERS UNDER COMBINED FORCES AND TORSION

This appendix provides alternative interaction equations for braced frames with I-shaped members with  $b_f / d \leq 1.0$  and box-shaped members.

#### H3. ALTERNATIVE INTERACTION EQUATIONS FOR MEMBERS UNDER COMBINED STRESS

For I-shaped members with  $b_f / d \leq 1.0$  and box-shaped members, the use of the following interaction equations in lieu of Equations H1-1a and H1-1b is permitted for braced frames only. Both Equations A-H3-1 and A-H3-2 shall be satisfied.

$$\left( \frac{M_{ux}}{\phi_b M'_{px}} \right)^\zeta + \left( \frac{M_{uy}}{\phi_b M'_{py}} \right)^\zeta \leq 1.0 \quad (\text{A-H3-1})$$

$$\left( \frac{C_{mx} M_{ux}}{\phi_b M'_{nx}} \right)^\eta + \left( \frac{C_{my} M_{uy}}{\phi_b M'_{ny}} \right)^\eta \leq 1.0 \quad (\text{A-H3-2})$$

The terms in Equations A-H3-1 and A-H3-2 are determined as follows:

(a) For I-shaped members:

For  $b_f / d < 0.5$ :

$$\zeta = 1.0$$

For  $0.5 \leq b_f / d \leq 1.0$ :

$$\zeta = 1.6 - \frac{P_u / P_y}{2 \left[ \ln(P_u / P_y) \right]} \quad (\text{A-H3-3})$$

For  $b_f / d < 0.3$ :

$$\eta = 1.0$$

For  $0.3 \leq b_f / d \leq 1.0$ :

$$\eta = 0.4 + \frac{P_u}{P_y} + \frac{b_f}{d} \geq 1.0 \quad (\text{A-H3-4})$$

where

$b_f$  = flange width, in. (mm)

$d$  = member depth, in. (mm)

$C_m$  = coefficient applied to the bending term in the interaction equation for prismatic members and dependent on column curvature caused by applied moments, see Section C1.

$$M'_{px} = 1.2M_{px} \left[ 1 - (P_u / P_y) \right] \leq M_{px} \quad (\text{A-H3-5})$$

$$M'_{py} = 1.2M_{py} \left[ 1 - (P_u / P_y)^2 \right] \leq M_{py} \quad (\text{A-H3-6})$$

$$M'_{nx} = M_{nx} \left( 1 - \frac{P_u}{\phi_c P_n} \right) \left( 1 - \frac{P_u}{P_{ex}} \right) \quad (\text{A-H3-7})$$

$$M'_{ny} = M_{ny} \left( 1 - \frac{P_u}{\phi_c P_n} \right) \left( 1 - \frac{P_u}{P_{ey}} \right) \quad (\text{A-H3-8})$$

(b) For box-section members:

$$\zeta = 1.7 - \frac{P_u / P_y}{\ln(P_u / P_y)} \quad (\text{A-H3-9})$$

$$\eta = 1.7 - \frac{P_u / P_y}{\ln(P_u / P_y)} - a\lambda_x \left( \frac{P_u}{P_y} \right)^b > 1.1 \quad (\text{A-H3-10})$$

For  $P_u / P_y \leq 4.0$ ,  $a = 0.06$ , and  $b = 1.0$ ;

For  $P_u / P_y > 4.0$ ,  $a = 0.15$ , and  $b = 2.0$ :

$$M'_{px} = 1.2M_{px} \left[ 1 - P_u / P_y \right] \leq M_{px} \quad (\text{A-H3-11a})$$

$$M'_{py} = 1.2M_{py} \left[ 1 - P_u / P_y \right] \leq M_{py} \quad (\text{A-H3-11b})$$

$$M'_{nx} = M_{nx} \left( 1 - \frac{P_u}{\phi_c P_n} \right) \left( 1 - \frac{P_u}{P_{ex}} \frac{1.25}{(B/H)^{1/3}} \right) \quad (\text{A-H3-12})$$

$$M'_{ny} = M_{ny} \left( 1 - \frac{P_u}{\phi_c P_n} \right) \left( 1 - \frac{P_u}{P_{ey}} \frac{1.25}{(B/H)^{1/2}} \right) \quad (\text{A-H3-13})$$

where

$P_n$  = nominal compressive strength determined in accordance with Section E2, kips (N)

$P_u$  = required axial strength, kips (N)

$P_y$  = compressive yield strength  $A_g F_y$ , kips (N)

$\phi_b$  = resistance factor for flexure = 0.90

$\phi_c$  = resistance factor for compression = 0.85

$P_e$  = Euler buckling strength  $A_g F_y / \lambda_c^2$ , where  $\lambda_c$  is the column slenderness parameter defined by Equation E2-4, kips (N)

$M_u$  = required flexural strength, kip-in. (N-mm)

$M_n$  = nominal flexural strength, determined in accordance with Section F1,  
kip-in. (N-mm)

$M_p$  = plastic moment  $\leq 1.5F_y S$ , kip-in. (N-mm)

$\lambda_x$  = column slenderness parameter with respect to the strong axis

$B$  = outside width of box section parallel to major principal axis  $x$ , in. (mm)

$H$  = outside depth of box section perpendicular to major principal axis  $x$ , in.  
(mm)

## APPENDIX J

### CONNECTIONS, JOINTS, AND FASTENERS

Appendix J2.4 provides the alternative design strength for fillet welds. Appendices J3.8 and J3.9 pertain to the design of slip-critical connections using service loads.

#### J2. WELDS

##### 4. Design Strength

In lieu of the constant design strength for fillet welds given in Table J2.5, the following procedure is permitted.

- (a) For a linear weld group loaded in-plane through the center of gravity, the design strength is  $\phi F_w A_w$ ,

where

$$F_w = 0.60 F_{EXX} (1.0 + 0.50 \sin^{1.5} \theta) \quad (\text{A-J2-1})$$

$$\phi = 0.75$$

$F_{EXX}$  = electrode classification number, i.e., minimum specified strength, ksi (MPa)

$\theta$  = angle of loading measured from the weld longitudinal axis, degrees

$A_w$  = effective area of weld throat, in.<sup>2</sup> (mm<sup>2</sup>)

- (b) For weld elements within a weld group that are loaded in-plane and analyzed using an instantaneous center of rotation method, the components of the design strength are  $\phi F_{wx} A_w$  and  $\phi F_{wy} A_w$ ,

where

$$F_{wx} = \Sigma F_{wix}$$

$$F_{wy} = \Sigma F_{wiy}$$

$$F_{wi} = 0.60 F_{EXX} (1.0 + 0.50 \sin^{1.5} \theta) f(p)$$

$$f(p) = [p(1.9 - 0.9p)]^{0.3}$$

$$\phi = 0.75$$

$F_{wi}$  = nominal stress in any  $i$ th weld element, ksi (MPa)

$F_{wix}$  = x component of stress  $F_{wi}$

$F_{wiy}$  = y component of stress  $F_{wi}$

$p$  =  $\Delta_i / \Delta_m$ , ratio of element  $i$  deformation to its deformation at maximum stress

$\Delta_m$  =  $0.209(\theta + 2)^{-0.32} w$ , deformation of weld element at maximum stress, in. (mm)

$\Delta_i$  = deformation of weld elements at intermediate stress levels, linearly

**TABLE A-J3.1**  
**Nominal Tension Stress ( $F_t$ ), ksi (MPa)**  
**Fasteners in Bearing-type Connections**

Description of Fasteners	Threads Included in the Shear Plane	Threads Excluded from the Shear Plane
A307 bolts (Metric)	$\sqrt{45^2 - 6.25f_v^2}$  $(\sqrt{310^2 - 6.25f_v^2})$	
A325 bolts (A325M bolts)	$\sqrt{90^2 - 6.25f_v^2}$  $(\sqrt{621^2 - 6.25f_v^2})$	$\sqrt{90^2 - 4.00f_v^2}$  $(\sqrt{621^2 - 4.00f_v^2})$
A490 bolts (A490M bolts)	$\sqrt{113^2 - 6.31f_v^2}$  $\sqrt{113^2 - 6.31f_v^2}$	$\sqrt{113^2 - 4.04f_v^2}$  $\sqrt{779^2 - 4.04f_v^2}$
Threaded parts A449 bolts over 1½ in. (38 mm)	$\sqrt{(0.75F_u)^2 - 6.25f_v^2}$	$\sqrt{(0.75F_u)^2 - 4.00f_v^2}$
A502 Gr. 1 rivets (Metric)	$\sqrt{45^2 - 5.76f_v^2}$  $(\sqrt{310^2 - 5.76f_v^2})$	
A502 Gr. 2 rivets (Metric)	$\sqrt{60^2 - 5.86f_v^2}$  $(\sqrt{414^2 - 5.86f_v^2})$	

**TABLE A-J3.2**  
**Slip-Critical Nominal Resistance to Shear,  $F_v$ ,**  
**ksi (MPa), of High-Strength Bolts<sup>[a]</sup>**

Type of Bolt	Nominal Resistance to Shear, ksi (MPa)			
	Standard Size Holes	Oversized and Short-slotted Holes	Long-slotted Holes	
			Perpendicular to Line of Force	Parallel to Line of Force
A325 (A325M)	17 (117)	15 (103)	12 (83)	10 (69)
A490 (A490M)	21 (145)	18 (124)	15 (103)	13 (90)

[a] For each shear plane.

proportioned to the critical deformation based on distance from the instantaneous center of rotation,  $r_i$ , in. (mm)

$$\Delta_u = r_i \Delta_u / r_{crit}$$

$$\Delta_u = 1.087(\theta + 6)^{-0.65} w \leq 0.17w, \text{ deformation of weld element at ultimate stress (fracture), usually in element furthest from instantaneous center of rotation, in. (mm)}$$

$$w = \text{leg size of the fillet weld, in. (mm)}$$

$$r_{crit} = \text{distance from instantaneous center of rotation to weld element with minimum } \Delta_u / r_i \text{ ratio, in. (mm)}$$

### J3. BOLTS AND THREADED PARTS

#### 7. Combined Tension and Shear in Bearing-Type Connections

As an alternative to the use of the equations in Table J3.5, the use of the equations in Table A-J3.1 is permitted.

#### 8. High-Strength Bolts in Slip-Critical Connections

##### 8b. Slip-Critical Connections Designed at Service Loads

The design resistance to shear per bolt  $\phi F_v A_b$  for use at service loads shall equal or exceed the shear per bolt due to service loads,

where

$\phi = 1.0$  for standard, oversized, and short-slotted holes and long-slotted holes when the long slot is perpendicular or parallel to the line of force  
 $F_v$  = nominal slip-critical shear resistance tabulated in Table A-J3.2, ksi (MPa). The values for  $F_v$  in Table A-J3.2 are based on Class A surfaces with slip coefficient  $\mu = 0.33$ . When specified by the designer, the nominal slip resistance for connections having special faying surface conditions is permitted to be adjusted to the applicable values in the RCSC Load and Resistance Factor Design Specification.

When the loading combination includes wind loads in addition to dead and live loads, the total shear on the bolt due to combined load effects, at service load, may be multiplied by 0.75.

#### 9. Combined Tension and Shear in Slip-Critical Connections

##### 9b. Slip-Critical Connections Designed at Service Loads

When a slip-critical connection is subjected to an applied tension  $T$  that reduces the net clamping force, the slip resistance per bolt,  $\phi F_v A_b$ , according to Appendix J3.8b shall be multiplied by the following factor:

$$1 - \frac{T}{0.8T_b N_b}$$

where

$T_b$  = minimum fastener tension from Table J3.1, kips (N)

$N_b$  = number of bolts carrying service-load tension  $T$

## APPENDIX K

### CONCENTRATED FORCES, PONDING, AND FATIGUE

Appendix K2 provides an alternative determination of roof stiffness. Appendix K3 pertains to the design of members and connections subject to high cyclic loading (fatigue).

#### K2. PONDING

The provisions of this Appendix are permitted to be used when a more exact determination of flat roof framing stiffness is needed than that given by the provision of Section K2 that  $C_p + 0.9C_s \leq 0.25$ .

For any combination of primary and secondary framing, the stress index is computed as

$$(A-K2-1)$$

$$(A-K2-2)$$

where

$f_o$  = the stress due to  $1.2D + 1.2R$  ( $D$  = nominal dead load,  $R$  = nominal load due to rain water or ice exclusive of the ponding contribution),\* ksi (MPa)

Enter Figure A-K2.1 at the level of the computed stress index  $U_p$  determined for the primary beam; move horizontally to the computed  $C_s$  value of the secondary beams and then downward to the abscissa scale. The combined stiffness of the primary and secondary framing is sufficient to prevent ponding if the flexibility constant read from this latter scale is more than the value of  $C_p$  computed for the given primary member; if not, a stiffer primary or secondary beam, or combination of both, is required. In the above,

$$C_p = \frac{32L_s L_p^4}{10^7 I_p}$$

$$\left( \text{Metric: } C_p = \frac{504L_s L_p^4}{I_p} \right)$$

$$C_s = \frac{32SL_s^4}{10^7 I_s}$$

---

\*Depending upon geographic location, this loading should include such amount of snow as might also be present, although ponding failures have occurred more frequently during torrential summer rains when the rate of precipitation exceeded the rate of drainage runoff and the resulting hydraulic gradient over large roof areas caused substantial accumulation of water some distance from the eaves. A load factor of 1.2 shall be used for loads resulting from these phenomena.

$$\left( \text{Metric: } C_s = \frac{504SL_s^4}{I_s} \right)$$

where

- $L_p$  = column spacing in direction of girder (length of primary members), ft (m)
- $L_s$  = column spacing perpendicular to direction of girder (length of secondary members), ft (m)
- $S$  = spacing of secondary members, ft (m)
- $I_p$  = moment of inertia of primary members, in.<sup>4</sup> (mm<sup>4</sup>)
- $I_s$  = moment of inertia of secondary members, in.<sup>4</sup> (mm<sup>4</sup>)

A similar procedure must be followed using Figure A-K2.2.

Roof framing consisting of a series of equally spaced wall-bearing beams is consid-

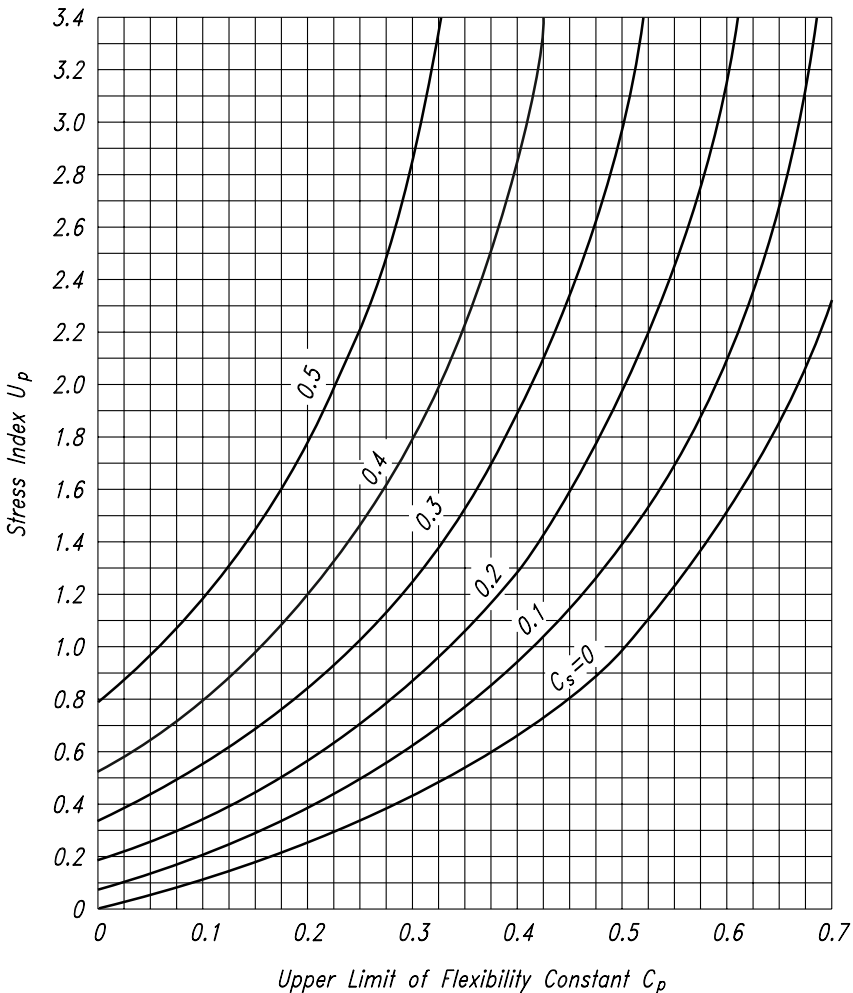

Fig. A-K2.1. Limiting flexibility coefficient for the primary systems.



ered as consisting of secondary members supported on an infinitely stiff primary member. For this case, enter Figure A-K2.2 with the computed stress index  $U_s$ . The limiting value of  $C_s$  is determined by the intercept of a horizontal line representing the  $U_s$  value and the curve for  $C_p = 0$ .

The ponding deflection contributed by a metal deck is usually such a small part of the total ponding deflection of a roof panel that it is sufficient merely to limit its moment of inertia (per foot (meter) of width normal to its span) to 0.000025 (3 940) times the fourth power of its span length. However, the stability against ponding of a roof consisting of a metal roof deck of relatively slender depth-span ratio, spanning between beams supported directly on columns, may need to be checked. This can be done using Figure A-K2.1 or A-K2.2 using as  $C_s$  the flexibility constant for a one-foot (one-meter) width of the roof deck ( $S = 1.0$ ).

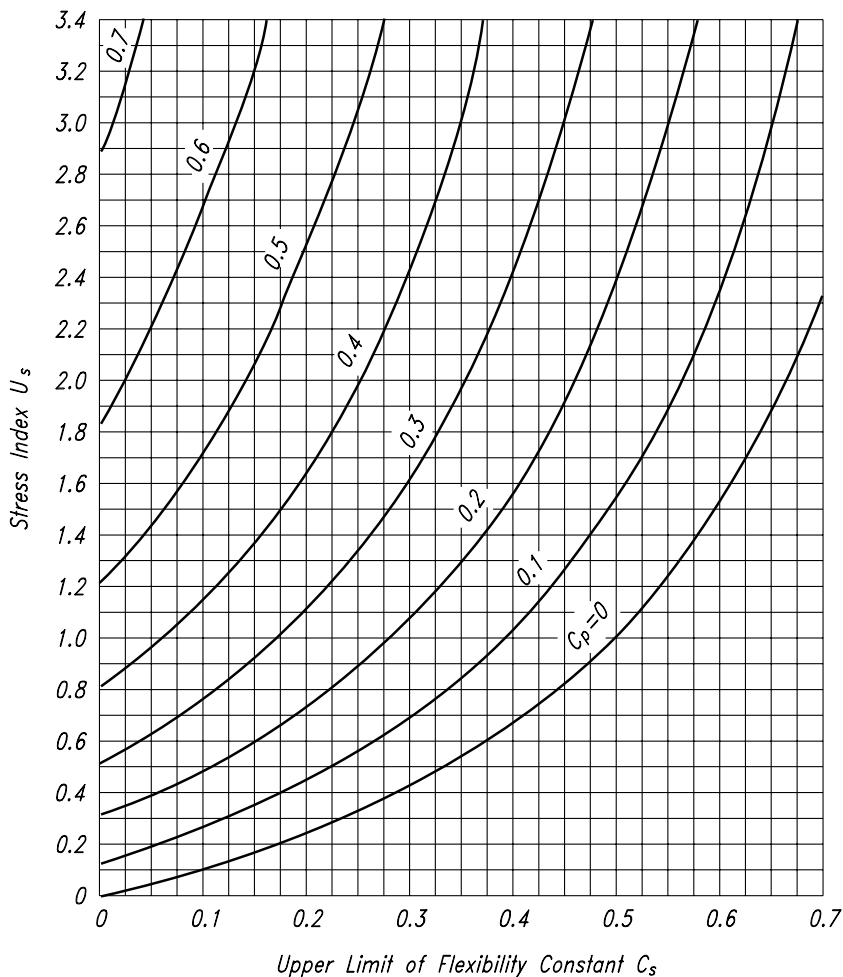

Fig. A-K2.2. Limiting flexibility coefficient for the secondary systems.

Since the shear rigidity of the web system of steel joists and trusses is less than that of a solid plate, their moment of inertia shall be taken as 85 percent of their chords.

### **K3. DESIGN FOR CYCLIC LOADING (FATIGUE)**

This appendix applies to members and connections subject to high cycle loading within the elastic range of stresses of frequency and magnitude sufficient to initiate cracking and progressive failure (fatigue).

#### **1. General**

The provisions of this section apply to stresses calculated on the basis of unfactored loads. The maximum permitted stress due to unfactored loads is  $0.66F_y$ .

Stress range is defined as the magnitude of the change in stress due to the application or removal of the unfactored live load. In the case of a stress reversal, the stress range shall be computed as the numerical sum of maximum repeated tensile and compressive stresses or the numerical sum of maximum shearing stresses of opposite direction at the point of probable crack initiation.

In the case of complete-joint-penetration butt welds, the maximum design stress range calculated by Equation A-K3.1 applies only to welds with internal soundness meeting the acceptance requirements of Section 6.12.2 or 6.13.2 of AWS D1.1.

No evaluation of fatigue resistance is required if the live load stress range is less than the threshold stress range,  $F_{TH}$ . See Table A-K3.1.

No evaluation of fatigue resistance is required if the number of cycles of application of live load is less than  $2 \times 10^4$ .

The cyclic load resistance determined by the provisions of this appendix is applicable to structures with suitable corrosion protection or subject only to mildly corrosive atmospheres, such as normal atmospheric conditions.

The cyclic load resistance determined by the provisions of this appendix is applicable only to structures subject to temperatures not exceeding 300°F (150°C).

The Engineer of Record shall provide either complete details including weld sizes or shall specify the planned cycle life and the maximum range of moments, shears and reactions for the connections.

#### **2. Calculation of Maximum Stresses and Stress Ranges**

Calculated stresses shall be based upon elastic analysis. Stresses shall not be amplified by stress concentration factors for geometrical discontinuities.

For bolts and threaded rods subject to axial tension, the calculated stresses shall include the effects of prying action, if any.

In the case of axial stress combined with bending, the maximum stresses, of each kind, shall be those determined for concurrent arrangements of the applied load.

For members having symmetric cross sections, the fasteners and welds shall be arranged symmetrically about the axis of the member, or the total stresses including those due to eccentricity shall be included in the calculation of the stress range.

For axially loaded angle members where the center of gravity of the connecting welds lies between the line of the center of gravity of the angle cross section and the

center of the connected leg, the effects of eccentricity shall be ignored. If the center of gravity of the connecting welds lies outside this zone, the total stresses, including those due to joint eccentricity, shall be included in the calculation of stress range.

### 3. Design Stress Range

The range of stress at service loads shall not exceed the stress range computed as follows.

- (a) For stress categories A, B, B', C, D, E and E' the design stress range,  $F_{SR}$ , shall be determined by Equation A-K3.1 or A-K3.1M.

$$F_{SR} = \left( \frac{C_f}{N} \right)^{0.333} \geq F_{TH} \quad (\text{A-K3.1})$$

$$\left( \text{Metric: } F_{SR} = \left( \frac{C_f \times 327}{N} \right)^{0.333} \geq F_{TH} \right) \quad (\text{A-K3.1M})$$

where

$F_{SR}$  = Design stress range, ksi (MPa)

$C_f$  = Constant from Table A-K3.1 for the category

$N$  = Number of stress range fluctuations in design life

= Number of stress range fluctuations per day  $\times$  365  $\times$  years of design life

$F_{TH}$  = Threshold fatigue stress range, maximum stress range for indefinite design life from Table A-K3.1, ksi (MPa)

- (b) For stress category F, the design stress range,  $F_{SR}$ , shall be determined by Equation A-K3.2 or A-K3.2M.

$$F_{SR} = \left( \frac{C_f}{N} \right)^{0.167} \geq F_{TH} \quad (\text{A-K3.2})$$

$$\left( \text{Metric: } F_{SR} = \left( \frac{C_f \times 11 \times 10^4}{N} \right)^{0.167} \geq F_{TH} \right) \quad (\text{A-K3.2M})$$

- (c) For tension-loaded plate elements connected at their end by cruciform, T- or corner details with complete-joint-penetration groove welds or partial-joint-penetration groove welds, fillet welds, or combinations of the preceding, transverse to the direction of stress, the design stress range on the cross section of the tension-loaded plate element at the toe of the weld shall be determined as follows:

*Based upon crack initiation from the toe of the weld on the tension loaded plate element* the design stress range,  $F_{SR}$ , shall be determined by Equation A-K3.1 or A-K3.1M, for Category C which is equal to

$$F_{SR} = \left( \frac{44 \times 10^8}{N} \right)^{0.333} \geq 10$$

$$\left( \text{Metric: } F_{SR} = \left( \frac{14.4 \times 10^{11}}{N} \right)^{0.333} \geq 68.9 \right)$$

Based upon crack initiation from the root of the weld the design stress range,  $F_{SR}$ , on the tension loaded plate element using transverse partial-joint-penetration groove welds, with or without reinforcing or contouring fillet welds, the design stress range on the cross section at the toe of the weld shall be determined by Equation A-K3.3 or A-K3.3M, Category C' as follows:

$$F_{SR} = R_{PJP} \left( \frac{44 \times 10^8}{N} \right)^{0.333} \quad (\text{A-K3.3})$$

$$\left( \text{Metric: } F_{SR} = 1.72 R_{PJP} \left( \frac{14.4 \times 10^{11}}{N} \right)^{0.333} \right) \quad (\text{A-K3.3M})$$

where:

$R_{PJP}$  = reduction factor for reinforced or non-reinforced transverse partial-joint-penetration (PJP) joints. Use Category C if  $R_{PJP} = 1.0$ .

$$= \left( \frac{0.65 - 0.59 \left( \frac{2a}{t_p} \right) + 0.72 \left( \frac{w}{t_p} \right)}{t_p^{0.167}} \right) \leq 1.0$$

$2a$  = the length of the non-welded root face in the direction of the thickness of the tension-loaded plate, in. (mm)

$w$  = the leg size of the reinforcing or contouring fillet, if any, in the direction of the thickness of the tension-loaded plate, in. (mm)

$t_p$  = thickness of tension loaded plate, in. (mm)

Based upon crack initiation from the roots of a pair of transverse fillet welds on opposite sides of the tension loaded plate element the design stress range,  $F_{SR}$ , on the cross section at the toe of the welds shall be determined by Equation A-K3.4 or A-K3.4M, Category C'' as follows:

$$F_{SR} = R_{FIL} \left( \frac{44 \times 10^8}{N} \right)^{0.333} \quad (\text{A-K3.4})$$

$$\left( \text{Metric: } F_{SR} = 1.72 R_{FIL} \left( \frac{14.4 \times 10^{11}}{N} \right)^{0.333} \right) \quad (\text{A-K3.4M})$$

where

$R_{FIL}$  = reduction factor for joints using a pair of transverse fillet welds only. Use Category C if  $R_{FIL} = 1.0$ .

$$= \left( \frac{0.06 + 0.72(w / t_p)}{t_p^{0.167}} \right) \leq 1.0$$

#### 4. Bolts and Threaded Parts

The range of stress at service loads shall not exceed the stress range computed as follows.

- (a) For mechanically fastened connections loaded in shear, the maximum range of stress in the connected material at service loads shall not exceed the design stress range computed using Equation A-K3.1 where  $C_f$  and  $F_{TH}$  are taken from Section 2 of Table A-K3.1.
- (b) For high-strength bolts, common bolts, and threaded anchor rods with cut, ground or rolled threads, the maximum range of tensile stress on the net tensile area from applied axial load and moment plus load due to prying action shall not exceed the design stress range computed using Equation A-K3.1 or A-K3.1M. The factor  $C_f$  shall be taken as  $3.9 \times 10^8$  (as for category E'). The threshold stress,  $F_{TH}$  shall be taken as 7 ksi (48 MPa) (as for category D). The net tensile area is given by Equation A-K3.5 and A-K3.6M.

$$A_t = \frac{\pi}{4} \left( d_b - \frac{0.9743}{n} \right)^2 \quad (\text{A-K3.5})$$

$$\left( \text{Metric bolts : } A_t = \frac{\pi}{4} (d_b - 0.9382P)^2 \right) \quad (\text{A-K3.6M})$$

where

$P$  = pitch, mm per thread

$d_b$  = the nominal diameter (body or shank diameter), in. (mm)

$n$  = threads per in.

For joints in which the material within the grip is not limited to steel or joints which are not tensioned to the requirements of Table J3.1 or J3.1M, all axial load and moment applied to the joint plus effects of prying action (if any) shall be assumed to be carried exclusively by the bolts or rods.

For joints in which the material within the grip is limited to steel and which are tensioned to the requirements of Table J3.1 or J3.1M, an analysis of the relative stiffness of the connected parts and bolts shall be permitted to be used to determine the tensile stress range in the pretensioned bolts due to the total service live load and moment plus effects of prying action. Alternatively, the stress range in the bolts shall be assumed to be equal to the stress on the net tensile area due to 20 percent of the absolute value of the service load axial load and moment from dead, live and other loads.

#### 5. Special Fabrication and Erection Requirements

Longitudinal backing bars are permitted to remain in place, and if used, shall be continuous. If splicing is necessary for long joints, the bar shall be joined with complete penetration butt joints and the reinforcement ground prior to assembly in the joint.

In transverse joints subject to tension, backing bars, if used, shall be removed and the joint back gouged and welded.

In transverse complete-joint-penetration T- and corner joints, a reinforcing fillet weld, not less than  $\frac{1}{4}$  in. (6 mm) in size shall be added at re-entrant corners.

The surface roughness of flame cut edges subject to significant cyclic tensile stress ranges shall not exceed 1,000  $\mu\text{in.}$  (25  $\mu\text{m}$ ), where ASME B46.1 is the reference standard.

Re-entrant corners at cuts, copes and weld access holes shall form a radius of not less than  $\frac{3}{8}$  in. (10 mm) by pre-drilling or sub-punching and reaming a hole, or by thermal cutting to form the radius of the cut. If the radius portion is formed by thermal cutting, the cut surface shall be ground to a bright metal surface.

For transverse butt joints in regions of high tensile stress, run-off tabs shall be used to provide for cascading the weld termination outside the finished joint. End dams shall not be used. Run-off tabs shall be removed and the end of the weld finished flush with the edge of the member.

See Section J2.2b *Fillet Weld Terminations* for requirements for end returns on certain fillet welds subject to cyclic service loading.

**TABLE A-K3.1**  
**Fatigue Design Parameters**

Description	Stress Category	Constant $C_f$	Threshold $F_{TH}$ ksi (MPa)	Potential Crack Initiation Point
<b>SECTION 1 – PLAIN MATERIAL AWAY FROM ANY WELDING</b>				
1.1 Base metal, except non-coated weathering steel, with rolled or cleaned surface. Flame-cut edges with surface roughness value of 1,000 $\mu\text{in.}$ (25 $\mu\text{m}$ ) or less, but without re-entrant corners.	A	$250 \times 10^8$	24 (165)	Away from all welds or structural connections
1.2 Non-coated weathering steel base metal with rolled or cleaned surface. Flame-cut edges with surface roughness value of 1,000 $\mu\text{in.}$ (25 $\mu\text{m}$ ) or less, but without re-entrant corners.	B	$120 \times 10^8$	16 (110)	Away from all welds or structural connections
1.3 Member with drilled or reamed holes. Member with re-entrant corners at copes, cuts, block-outs or other geometrical discontinuities made to requirements of Appendix K3.5, except weld access holes.	B	$120 \times 10^8$	16 (110)	At any external edge or at hole perimeter
1.4 Rolled cross sections with weld access holes made to requirements of Section J1.6 and Appendix K3.5. Members with drilled or reamed holes containing bolts for attachment of light bracing where there is a small longitudinal component of brace force.	C	$44 \times 10^8$	10 (69)	At re-entrant corner of weld access hole or at any small hole (may contain bolt for minor connections)
<b>SECTION 2 – CONNECTED MATERIAL IN MECHANICALLY FASTENED JOINTS</b>				
2.1 Gross area of base metal in lap joints connected by high-strength bolts in joints satisfying all requirements for slip-critical connections.	B	$120 \times 10^8$	16 (110)	Through gross section near hole
2.2 Base metal at net section of high-strength bolted joints, designed on the basis of bearing resistance, but fabricated and installed to all requirements for slip-critical connections.	B	$120 \times 10^8$	16 (110)	In net section originating at side of hole
2.3 Base metal at the net section of other mechanically fastened joints except eye bars and pin plates.	D	$22 \times 10^8$	7 (48)	In net section originating at side of hole
2.4 Base metal at net section of eyebar head or pin plate.	E	$11 \times 10^8$	4.5 (31)	In net section originating at side of hole

**TABLE A-K3.1 (Cont'd)**  
**Fatigue Design Parameters**

**Illustrative Typical Examples**

**SECTION 1 - PLAIN MATERIAL AWAY FROM ANY WELDING**

1.1 and 1.2

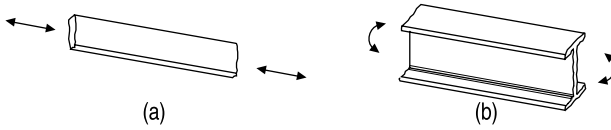

1.3

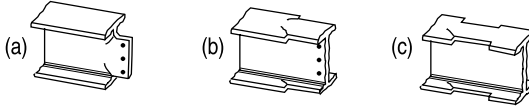

1.4

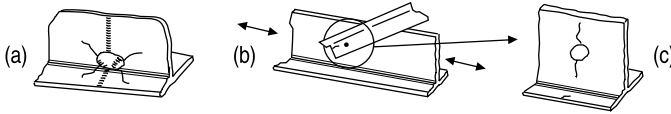

**SECTION 2 - CONNECTED MATERIAL IN MECHANICALLY FASTENED JOINTS**

2.1

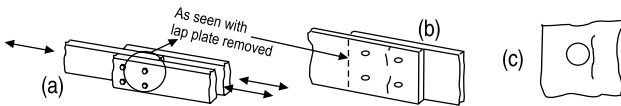

2.2

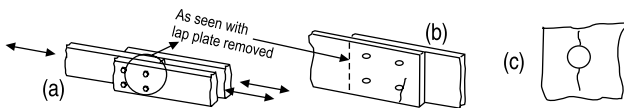

2.3

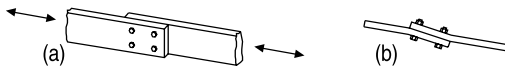

2.4





**TABLE A-K3.1 (Cont'd)**  
**Fatigue Design Parameters**

Description	Stress Category	Constant $C_f$	Threshold $F_{TH}$ ksi (MPa)	Potential Crack Initiation Point
<b>SECTION 3 – WELDED JOINTS JOINING COMPONENTS OF BUILT-UP MEMBERS</b>				
3.1 Base metal and weld metal in members without attachments built-up of plates or shapes connected by continuous longitudinal complete-joint-penetration groove welds, back gouged and welded from second side, or by continuous fillet welds.	B	$120 \times 10^8$	16 (110)	From surface or internal discontinuities in weld away from end of weld
3.2 Base metal and weld metal in members without attachments built-up of plates or shapes, connected by continuous longitudinal complete penetration groove welds with backing bars not removed, or by continuous partial-joint-penetration groove welds.	B'	$61 \times 10^8$	12 (83)	From surface or internal discontinuities in weld, including weld attaching backing bars
3.3 Base metal and weld metal termination of longitudinal welds at weld access holes in connected built-up members.	D	$22 \times 10^8$	7 (48)	From the weld termination into the web or flange
3.4 Base metal at ends of longitudinal intermittent fillet weld segments.	E	$11 \times 10^8$	4.5 (31)	In connected material at start and stop locations of any weld deposit
3.5 Base metal at ends of partial length welded coverplates narrower than the flange having square or tapered ends, with or without welds across the ends of coverplates wider than the flange with welds across the ends. Flange thickness $\leq 0.8$ in. (20 mm) Flange thickness $> 0.8$ in. (20 mm)	E  E'	$11 \times 10^8$  $3.9 \times 10^8$	  4.5 (31)  2.6 (18)	In flange at toe of end weld or in flange at termination of longitudinal weld or in edge of flange with wide coverplates
3.6 Base metal at ends of partial length welded coverplates wider than the flange without welds across the ends.	E'	$3.9 \times 10^8$	2.6 (18)	In edge of flange at end of coverplate weld
<b>SECTION 4 – LONGITUDINAL FILLET WELDED END CONNECTIONS</b>				
4.1 Base metal at junction of axially loaded members with longitudinally welded end connections. Welds shall be on each side of the axis of the member to balance weld stresses. $t \leq \frac{1}{2}$ -in. (13 mm) $t > \frac{1}{2}$ -in. (13 mm)	  E  E'	  $11 \times 10^8$  $3.9 \times 10^8$	  4.5 (31)  2.6 (18)	Initiating from end of any weld termination extending into the base metal

**TABLE A-K3.1 (Cont'd)**  
**Fatigue Design Parameters**

**Illustrative Typical Examples**

**SECTION 3 - WELDED JOINTS JOINING COMPONENTS OF BUILT-UP MEMBERS**

3.1

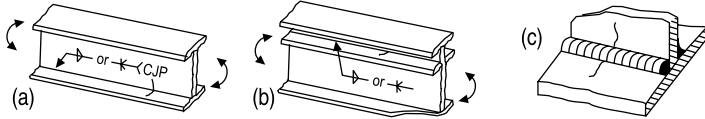

3.2

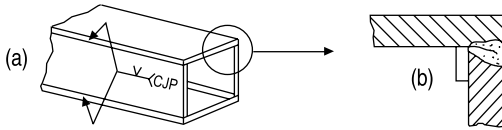

3.3

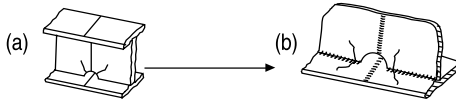

3.4

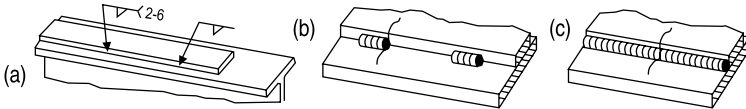

3.5

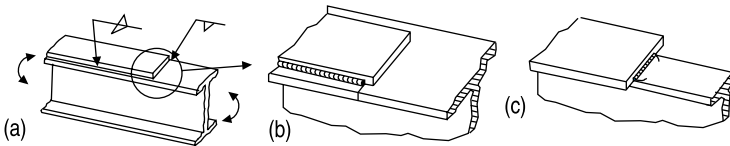

3.6

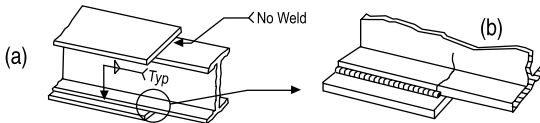

**SECTION 4 - LONGITUDINAL FILLET WELDED END CONNECTIONS**

4.1

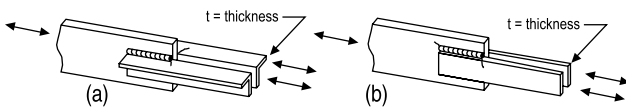

**TABLE A-K3.1 (Cont'd)**  
**Fatigue Design Parameters**

Description	Stress Category	Constant $C_f$	Threshold $F_{TH}$ ksi (MPa)	Potential Crack Initiation Point
<b>SECTION 5 – WELDED JOINTS TRANSVERSE TO DIRECTION OF STRESS</b>				
5.1 Base metal and weld metal in or adjacent to complete joint penetration groove welded splices in rolled or welded cross sections with welds ground essentially parallel to the direction of stress.	B	$120 \times 10^8$	16 (110)	From internal discontinuities in filler metal or along the fusion boundary
5.2 Base metal and weld metal in or adjacent to complete joint penetration groove welded splices with welds ground essentially parallel to the direction of stress at transitions in thickness or width made on a slope no greater than 8 to 20%. $F_y < 90$ ksi (620 MPa)	B	$120 \times 10^8$	16 (110)	From internal discontinuities in filler metal or along fusion boundary or at start of transition when $F_y \geq 90$ ksi (620 MPa)
	B'	$61 \times 10^8$	12 (83)	
5.3 Base metal with $F_y$ equal to or greater than 90 ksi (620 MPa) and weld metal in or adjacent to complete joint penetration groove welded splices with welds ground essentially parallel to the direction of stress at transitions in width made on a radius of not less than 2 ft. (600 mm) with the point of tangency at the end of the groove weld.	B	$120 \times 10^8$	16 (110)	From internal discontinuities in filler metal or discontinuities along the fusion boundary
5.4 Base metal and weld metal in or adjacent to the toe of complete joint penetration T or corner joints or splices, with or without transitions in thickness having slopes no greater than 8 to 20%, when weld reinforcement is not removed.	C	$44 \times 10^8$	10 (69)	From surface discontinuity at toe of weld extending into base metal or along fusion boundary.
5.5 Base metal and weld metal at transverse end connections of tension-loaded plate elements using partial joint penetration butt or T or corner joints, with reinforcing or contouring fillets, $F_{SR}$ shall be the smaller of the toe crack or root crack stress range. Crack initiating from weld toe:	C	$44 \times 10^8$	10 (69)	Initiating from geometrical discontinuity at toe of weld extending into base metal or, initiating at weld root subject to tension extending up and then out through weld
	C'	Eqn. A-K3.3 or A-K3.3M	None provided	

**TABLE A-K3.1 (Cont'd)**  
**Fatigue Design Parameters**

**Illustrative Typical Examples**

**SECTION 5 – WELDED JOINTS TRANSVERSE TO DIRECTION OF STRESS**

5.1

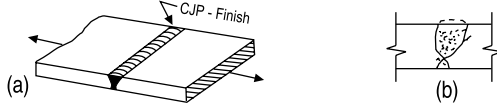

5.2

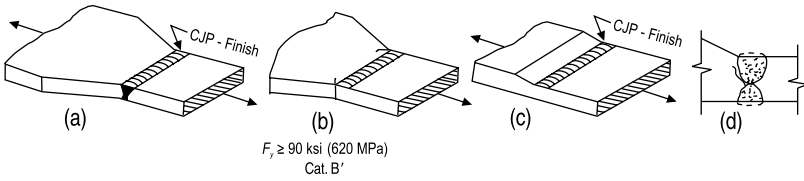

5.3

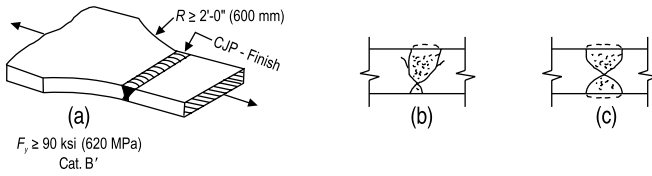

5.4

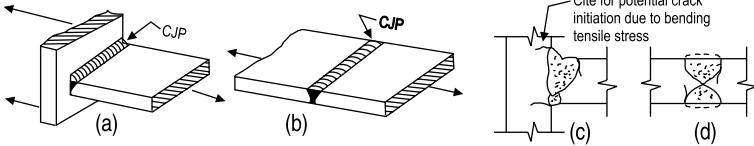

5.5

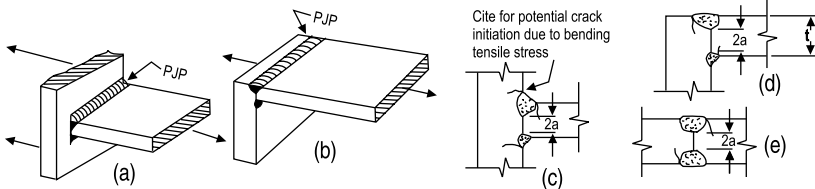

**TABLE A-K3.1 (Cont'd)  
Fatigue Design Parameters**

Description	Stress Category	Constant $C_f$	Threshold $F_{TH}$ ksi (MPa)	Potential Crack Initiation Point
<b>SECTION 5 – WELDED JOINTS TRANSVERSE TO DIRECTION OF STRESS (cont'd)</b>				
<p>5.6 Base metal and filler metal at transverse end connections of tension-loaded plate elements using a pair of fillet welds on opposite sides of the plate. <math>F_{SR}</math> shall be the smaller of the toe crack or root crack stress range.</p> <p>Crack initiating from weld toe:</p> <p>Crack initiating from weld root:</p>	<p>C</p> <p>C''</p>	<p><math>44 \times 10^8</math></p> <p>Eqn. A-K3.4 or A-K3.4M</p>	<p>10 (69)</p> <p>None provided</p>	<p>Initiating from geometrical discontinuity at toe of weld extending into base metal or, initiating at weld root subject to tension extending up and then out through weld</p>
<p>5.7 Base metal of tension loaded plate elements and on girders and rolled beam webs or flanges at toe of transverse fillet welds adjacent to welded transverse stiffeners.</p>	<p>C</p>	<p><math>44 \times 10^8</math></p>	<p>10 (69)</p>	<p>From geometrical discontinuity at toe of fillet extending into base metal</p>
<b>SECTION 6 – BASE METAL AT WELDED TRANSVERSE MEMBER CONNECTIONS</b>				
<p>6.1 Base metal at details attached by complete joint penetration groove welds subject to longitudinal loading only when the detail embodies a transition radius <math>R</math> with the weld termination ground smooth.</p> <p><math>R \geq 24</math> in. (600 mm)</p> <p>24 in. <math>&gt; R \geq 6</math> in. (600 mm <math>&gt; R \geq 150</math> mm)</p> <p>6 in. <math>&gt; R \geq 2</math> in. (150 mm <math>&gt; R \geq 50</math> mm)</p> <p>2 in. (50 mm) <math>&gt; R</math></p>	<p>B</p> <p>C</p> <p>D</p> <p>E</p>	<p><math>120 \times 10^8</math></p> <p><math>44 \times 10^8</math></p> <p><math>22 \times 10^8</math></p> <p><math>11 \times 10^8</math></p>	<p>16 (110)</p> <p>10 (69)</p> <p>7 (48)</p> <p>4.5 (31)</p>	<p>Near point of tangency of radius at edge of member</p>

**TABLE A-K3.1 (Cont'd)**  
**Fatigue Design Parameters**

**Illustrative Typical Examples**

**SECTION 5 – WELDED JOINTS TRANSVERSE TO DIRECTION OF STRESS (cont'd)**

5.6

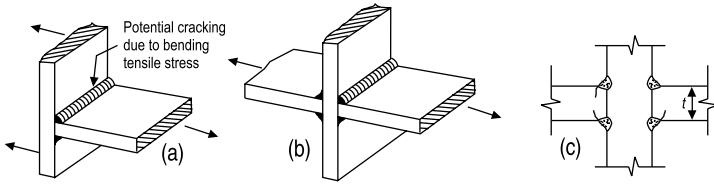

5.7

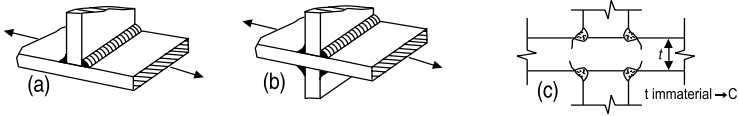

**SECTION 6 – BASE METAL AT WELDED TRANSVERSE MEMBER CONNECTIONS**

6.1

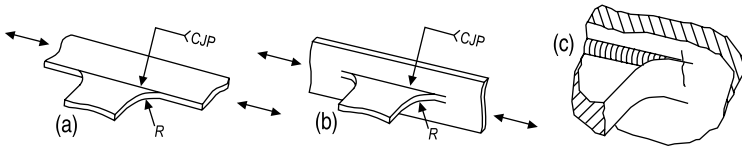

**TABLE A-K3.1 (Cont'd)**  
**Fatigue Design Parameters**

Description	Stress Category	Constant $C_f$	Threshold $F_{TH}$ ksi (MPa)	Potential Crack Initiation Point
<b>SECTION 6 – BASE METAL AT WELDED TRANSVERSE MEMBER CONNECTIONS (cont'd)</b>				
<p>6.2 Base metal at details of equal thickness attached by complete joint penetration groove welds subject to transverse loading with or without longitudinal loading when the detail embodies a transition radius <math>R</math> with the weld termination ground smooth:</p> <p>When weld reinforcement is removed:</p> <p style="padding-left: 20px;"><math>R \geq 24</math> in. (600 mm)</p> <p style="padding-left: 20px;">24 in. <math>&gt; R \geq 6</math> in. (600 mm <math>&gt; R \geq 150</math> mm)</p> <p style="padding-left: 20px;">6 in. <math>&gt; R \geq 2</math> in. (150 mm <math>&gt; R \geq 50</math> mm)</p> <p style="padding-left: 20px;">2 in. (50 mm) <math>&gt; R</math></p> <p>When weld reinforcement is not removed:</p> <p style="padding-left: 20px;"><math>R \geq 24</math> in. (600 mm)</p> <p style="padding-left: 20px;">24 in. <math>&gt; R \geq 6</math> in. (600 mm <math>&gt; R \geq 150</math> mm)</p> <p style="padding-left: 20px;">6 in. <math>&gt; R \geq 2</math> in. (150 mm <math>&gt; R \geq 50</math> mm)</p> <p style="padding-left: 20px;">2 in. (50 mm) <math>&gt; R</math></p>	<p style="text-align: center;">B</p> <p style="text-align: center;">C</p> <p style="text-align: center;">D</p> <p style="text-align: center;">E</p> <p style="text-align: center;">C</p> <p style="text-align: center;">C</p> <p style="text-align: center;">D</p> <p style="text-align: center;">E</p>	<p style="text-align: center;"><math>120 \times 10^8</math></p> <p style="text-align: center;"><math>44 \times 10^8</math></p> <p style="text-align: center;"><math>22 \times 10^8</math></p> <p style="text-align: center;"><math>11 \times 10^8</math></p> <p style="text-align: center;"><math>44 \times 10^8</math></p> <p style="text-align: center;"><math>44 \times 10^8</math></p> <p style="text-align: center;"><math>22 \times 10^8</math></p> <p style="text-align: center;"><math>11 \times 10^8</math></p>	<p style="text-align: center;">16 (110)</p> <p style="text-align: center;">10 (69)</p> <p style="text-align: center;">7 (48)</p> <p style="text-align: center;">4.5 (31)</p> <p style="text-align: center;">10 (69)</p> <p style="text-align: center;">10 (69)</p> <p style="text-align: center;">7 (48)</p> <p style="text-align: center;">4.5 (31)</p>	<p>Near points of tangency of radius or in the weld or at fusion boundary or member or attachment</p> <p>At toe of the weld either along edge of member or the attachment</p>
<p>6.3 Base metal at details of unequal thickness attached by complete joint penetration groove welds subject to transverse loading with or without longitudinal loading when the detail embodies a transition radius <math>R</math> with the weld termination ground smooth.</p> <p>When weld reinforcement is removed:</p> <p style="padding-left: 20px;"><math>R &gt; 2</math> in. (50 mm)</p> <p style="padding-left: 20px;"><math>R \leq 2</math> in. (50 mm)</p> <p>When reinforcement is not removed:</p> <p style="padding-left: 20px;">Any radius</p>	<p style="text-align: center;">D</p> <p style="text-align: center;">E</p> <p style="text-align: center;">E</p>	<p style="text-align: center;"><math>22 \times 10^8</math></p> <p style="text-align: center;"><math>11 \times 10^8</math></p> <p style="text-align: center;"><math>11 \times 10^8</math></p>	<p style="text-align: center;">7 (48)</p> <p style="text-align: center;">4.5 (31)</p> <p style="text-align: center;">4.5 (31)</p>	<p>At toe of weld along edge of thinner material</p> <p>In weld termination in small radius</p> <p>At toe of weld along edge of thinner material</p>

**TABLE A-K3.1 (Cont'd)**  
**Fatigue Design Parameters**

**Illustrative Typical Examples**

**SECTION 6 – BASE METAL AT WELDED TRANSVERSE MEMBER CONNECTIONS (cont'd)**

6.2

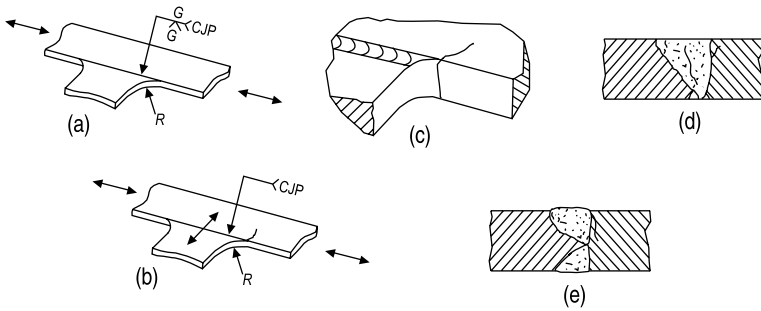

6.3

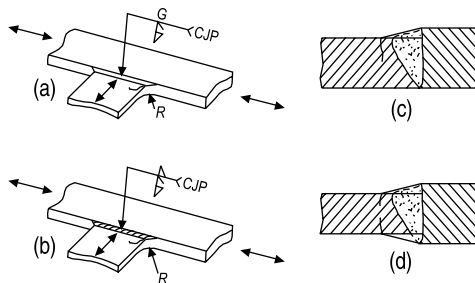



**TABLE A-K3.1 (Cont'd)**  
**Fatigue Design Parameters**

Description	Stress Category	Constant $C_f$	Threshold $F_{TH}$ Ksi (MPa)	Potential Crack Initiation Point
<b>SECTION 6 – BASE METAL AT WELDED TRANSVERSE MEMBER CONNECTIONS (cont'd)</b>				
6.4 Base metal subject to longitudinal stress at transverse members, with or without transverse stress, attached by fillet or partial penetration groove welds parallel to direction of stress when the detail embodies a transition radius, $R$ , with weld termination ground smooth: $R > 2$ in. (50 mm)	D	$22 \times 10^8$	7 (48)	In weld termination or from the toe of the weld extending into member
	E	$11 \times 10^8$	4.5 (31)	
$R \leq 2$ in. (50 mm)	E	$11 \times 10^8$	4.5 (31)	
<b>SECTION 7 – BASE METAL AT SHORT ATTACHMENTS<sup>1</sup></b>				
7.1 Base metal subject to longitudinal loading at details attached by complete penetration groove welds parallel to direction of stress where the detail embodies a transition radius, $R$ , less than 2 in. (50 mm), and with detail length in direction of stress, $a$ , and attachment height normal to surface of member, $b$ : $a < 2$ in. (50 mm)	C	$44 \times 10^8$	10 (69)	In the member at the end of the weld
	D	$22 \times 10^8$	7 (48)	
	E	$11 \times 10^8$	4.5 (31)	
	E'	$3.9 \times 10^8$	2.6 (18)	
$2$ in. (50 mm) $\leq a \leq 12b$ or 4 in. (100 mm)	D	$22 \times 10^8$	7 (48)	
$a > 12b$ or 4 in. (100 mm) when $b$ is $\leq 1$ in. (25 mm)	E	$11 \times 10^8$	4.5 (31)	
$a > 12b$ or 4 in. (100 mm) when $b$ is $> 1$ in. (25 mm)	E'	$3.9 \times 10^8$	2.6 (18)	
7.2 Base metal subject to longitudinal stress at details attached by fillet or partial joint penetration groove welds, with or without transverse load on detail, when the detail embodies a transition radius, $R$ , with weld termination ground smooth: $R > 2$ in. (50 mm)	D	$22 \times 10^8$	7 (48)	In weld termination extending into member
	E	$11 \times 10^8$	4.5 (31)	
$R \leq 2$ in. (50 mm)	E	$11 \times 10^8$	4.5 (31)	
<sup>1</sup> "Attachment" as used herein, is defined as any steel detail welded to a member which, by its mere presence and independent of its loading, causes a discontinuity in the stress flow in the member and thus reduces the fatigue resistance.				

**TABLE A-K3.1 (Cont'd)**  
**Fatigue Design Parameters**

**Illustrative Typical Examples**

**SECTION 6 – BASE METAL AT WELDED TRANSVERSE MEMBER CONNECTIONS (cont'd)**

6.4

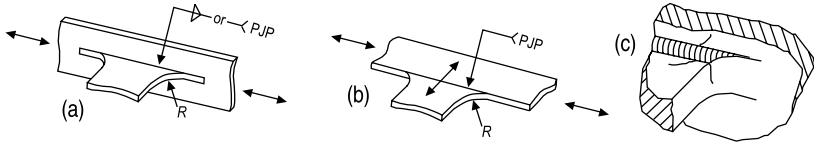

**SECTION 7 – BASE METAL AT SHORT ATTACHMENTS<sup>1</sup>**

7.1

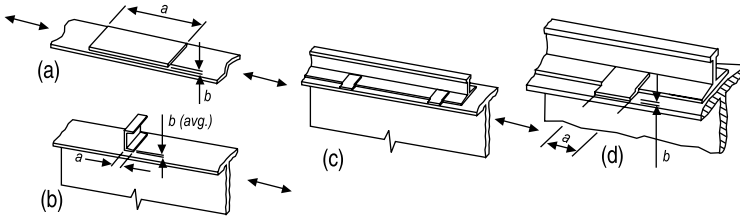

7.2

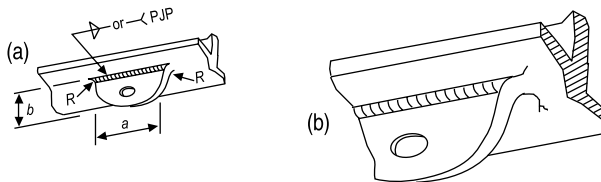

**TABLE A-K3.1 (Cont'd)**  
**Fatigue Design Parameters**

Description	Stress Category	Constant $C_f$	Threshold $F_{TH}$ Ksi (MPa)	Potential Crack Initiation Point
<b>SECTION 8 - MISCELLANEOUS</b>				
8.1 Base metal at stud-type shear connectors attached by fillet or electric stud welding.	C	$44 \times 10^8$	10 (69)	At toe of weld in base metal
8.2 Shear on throat of continuous or intermittent longitudinal or transverse fillet welds.	F	$150 \times 10^{10}$ (Eqn. A-K3.2 or A-K3.2M)	8 (55)	In throat of weld
8.3 Base metal at plug or slot welds.	E	$11 \times 10^8$	4.5 (31)	At end of weld in base metal
8.4 Shear on plug or slot welds.	F	$150 \times 10^{10}$ (Eqn. A-K3.2 or A-K3.2M)	8 (55)	At faying surface
8.5 Not fully-tightened high-strength bolts, common bolts, threaded anchor rods and hanger rods with cut, ground or rolled threads. Stress range on tensile stress area due to live load plus prying action when applicable.	E'	$3.9 \times 10^8$	7 (48)	At the root of the threads extending into the tensile stress area

**TABLE A-K3.1 (Cont'd)**  
**Fatigue Design Parameters**

**Illustrative Typical Examples**

**SECTION 8 - MISCELLANEOUS**

8.1



8.2

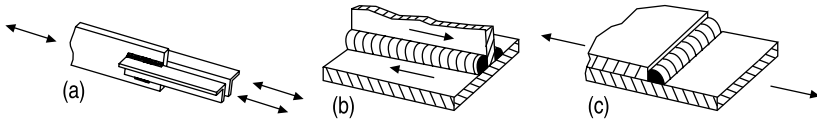

8.3

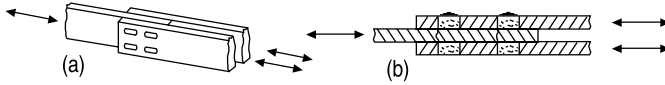

8.4

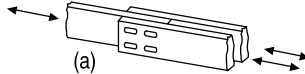

8.5

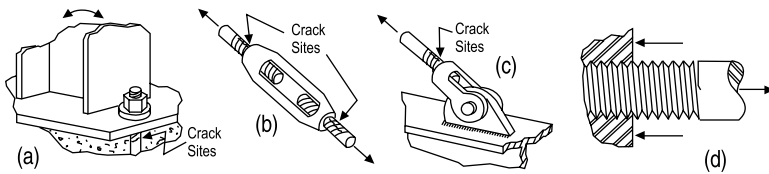

## NUMERICAL VALUES

<b>TABLE 1</b>			
<b>Design Strength as a Function of <math>F_y</math></b>			
<b><math>F_y</math></b> <b>ksi (MPa)</b>	<b>Design Stress, ksi (MPa)</b>		
	<b><math>0.9 \times 0.6 F_y</math> [a]</b>	<b><math>0.85 F_y</math> [b]</b>	<b><math>0.90 F_y</math> [c]</b>
33 (230)	17.8 (124)	28.1 (196)	29.7 (207)
35 (240)	18.9 (130)	29.8 (204)	31.5 (216)
36 (250)	19.4 (135)	30.6 (213)	32.4 (225)
40 (275)	21.6 (149)	34.0 (234)	36.0 (248)
42 (290)	22.7 (157)	35.7 (247)	37.8 (261)
45 (310)	24.3 (167)	38.3 (264)	40.5 (279)
46 (317)	24.8 (171)	39.1 (269)	41.4 (285)
50 (345)	27.0 (186)	42.5 (293)	45.0 (311)
55 (380)	29.7 (205)	46.8 (323)	49.5 (342)
60 (415)	32.4 (224)	51.0 (353)	54.0 (374)
65 (450)	35.1 (243)	55.3 (383)	58.5 (405)
70 (485)	37.8 (262)	59.5 (412)	63.0 (437)
90 (620)	48.6 (335)	76.5 (527)	81.0 (558)
100 (690)	54.0 (373)	85.0 (587)	90.0 (621)
[a] See Section F2, Equation F2-1 [b] See Section E2, Equation E2-1 [c] See Section D1, Equation D1-1			

**TABLE 2**  
**Design Strength as a Function of  $F_u$**

Item	ASTM Designation	Grade	$F_y$ Ksi (MPa)	$F_u$ Ksi (MPa)	Design Strength, ksi (MPa)				
					Connected Part of Designated Steel		Bolt or Threaded Part of Designated Steel		
					Tension $0.75 \times F_u$ [a]	Bearing $0.75 \times 2.4 F_u$ [b]	Tension $0.75 \times 0.75 F_u$ [c]	Shear $0.75 \times 0.40 F_u$ [d]	Shear $0.75 \times 0.50 F_u$ [e]
Shapes, Plates, Bars, Sheet and Tubing or Threaded parts	A36/A36M	-	36 (250)	58-80 (400-500)	43.5 (300)	104 (720)	32.6 (225)	17.4 (120)	21.8 (150)
	A53	-	35 (240)	60 (415)	45.0 (311)	108 (747)	-	-	-
	A242/A242M A588/A588M	-	50 (345)	70 (485)	52.5 (364)	126 (873)	39.4 (273)	21.0 (146)	26.3 (182)
		-	42 (290)	63 (435)	47.3 (326)	113 (783)	35.4 (245)	18.9 (131)	23.2 (163)
		-	20 (275)	60 (415)	45.0 (311)	108 (747)	33.8 (233)	18.0 (125)	22.5 (156)
	A500	-	33/39 [f] (230/269)	45 (310)	33.8 (233)	81.0 (558)	-	-	-
		-	42/46 [f] (290/315)	58 (400)	43.5 (300)	104 (720)	-	-	-
		-	46/50 [f] (315/345)	62 (427)	46.5 (320)	112 (769)	-	-	-
	A501	-	36 (250)	58 (400)	43.5 (300)	104 (720)	-	-	-
	A514/A514M	-	100 (690)	110-130 (760-895)	82.5 (570)	198 (1370)	61.9 (428)	33.0 (228)	41.3 (285)
		-	90 (620)	100-130 (690-895)	75.0 (518)	180 (1240)	56.3 (388)	30.0 (207)	37.5 (259)
	A529/A529M	-	50 (345)	70-100 (485-690)	52.5 (364)	126 (873)	39.4 (273)	21.0 (146)	26.3 (182)
-		55 (380)	70-100 (485-690)	52.5 (364)	126 (873)	39.4 (273)	21.0 (146)	26.3 (182)	
A570/A570M	-	40 (275)	55 (380)	41.3 (285)	99.0 (684)	-	-	-	
	-	42 (290)	58 (400)	43.5 (300)	104 (720)	-	-	-	
	-	42 (290)	55 (380)	41.3 (285)	99.0 (684)	-	-	-	
A572/A572M	42 (290)	42 (290)	60 (415)	45.0 (311)	108 (747)	33.8 (233)	18.0 (125)	22.5 (156)	
	50 (345)	50 (345)	65 (450)	48.8 (338)	117 (810)	36.6 (253)	19.5 (135)	24.2 (169)	
	55 (380)	55 (380)	70 (485)	52.5 (364)	126 (873)	39.4 (273)	21.0 (146)	26.3 (182)	
	60 (415)	60 (415)	75 (520)	56.3 (390)	135 (936)	42.2 (293)	22.5 (156)	28.1 (195)	
	65 (450)	65 (450)	80 (550)	60.0 (413)	144 (990)	45.0 (309)	24.0 (165)	30.0 (206)	

**TABLE 2 (cont'd)**  
**Design Strength as a Function of  $F_u$**

Item	ASTM Designation	Grade	$F_y$ Ksi (MPa)	$F_u$ Ksi (MPa)	Design Strength, ksi (MPa)				
					Connected Part of Designated Steel		Bolt or Threaded Part of Designated Steel		
					Tension $0.75 \times F_u$ [a]	Bearing $2.4 F_u$ [b]	Tension $0.75 \times F_u$ [c]	Shear $0.75 \times F_u$ [d]	Shear $0.75 \times F_u$ [e]
Shapes, Plates, Bars, Sheet and Tubing or Threaded parts	A606	-	45 (310)	65 (450)	48.8 (338)	117 (810)	-	-	-
			50 (345)	70 (485)	52.5 (364)	126 (873)	-	-	-
	A607	-	45 (310)	60 (415)	45.0 (311)	108 (747)	-	-	-
			50 (345)	65 (450)	48.8 (338)	117 (810)	-	-	-
			55 (380)	70 (485)	52.5 (364)	126 (873)	-	-	-
			60 (415)	75 (520)	56.3 (390)	135 (936)	-	-	-
			65 (450)	80 (550)	60.0 (413)	144 (990)	-	-	-
			70 (485)	85 (585)	63.8 (439)	153 (1050)	-	-	-
	A618	-	50 (345)	70 (485)	52.5 (364)	126 (873)	-	-	-
			50 (345)	65 (450)	48.8 (388)	117 (810)	-	-	-
	A913/A913M	50 (345)	50 (345)	65 (450)	48.8 (338)	117 (810)	36.6 (253)	19.5 (135)	24.4 (169)
			60 (415)	75 (520)	56.3 (390)	135 (936)	42.2 (293)	22.5 (156)	28.1 (195)
			65 (450)	80 (550)	60.0 (413)	144 (990)	45.0 (309)	24.0 (165)	30.0 (206)
			70 (485)	90 (620)	67.5 (465)	162 (1120)	50.6 (349)	27.0 (186)	33.8 (233)
A992/A992M	-	50 to 65 (345 to 450)	65 (450)	48.8 (338)	117 (810)	36.6 (253)	19.5 (135)	24.4 (169)	
Bolts	A449	-	92 (635)	120 (825)	-	-	67.5 (464)	36.0 (248)	45.0 (309)
			81 (560)	105 (725)	-	-	59.1 (408)	31.5 (218)	39.4 (272)
			58 (400)	90 (620)	-	-	50.6 (349)	27.0 (186)	33.8 (233)

[a] On effective net area, see Sections D1, J5.2.

[b] Produced by fastener in shear, see Section J3.10. Note that smaller maximum design bearing stresses, as a function of hole type spacing, are given.

[c] On nominal body area, see Table J3.2.

[d] Threads not excluded from shear plane, see Table J3.2.

[e] Threads excluded from shear plane, see Table J3.2.

[f] Smaller value for circular shapes, larger for square or rectangular shapes.

Note: For dimensional and size limitations, see the appropriate ASTM Specification.

**TABLE 3-36**  
**Design Stress for Compression Members of**  
**36 ksi Specified Yield Stress Steel,  $\phi_c = 0.85$ <sup>[a]</sup>**

$\frac{Kl}{r}$	$\phi_c F_{cr}$ ksi	$\frac{Kl}{r}$	$\phi_c F_{cr}$ ksi	$\frac{Kl}{r}$	$\phi_c F_{cr}$ ksi	$\frac{Kl}{r}$	$\phi_c F_{cr}$ ksi	$\frac{Kl}{r}$	$\phi_c F_{cr}$ ksi
1	30.6	41	28.0	81	21.7	121	14.2	161	8.23
2	30.6	42	27.9	82	21.5	122	14.0	162	8.13
3	30.6	43	27.8	83	21.3	123	13.8	163	8.03
4	30.6	44	27.6	84	21.1	124	13.6	164	7.93
5	30.6	45	27.5	85	20.9	125	13.4	165	7.84
6	30.5	46	27.4	86	20.7	126	13.3	166	7.74
7	30.5	47	27.2	87	20.5	127	13.1	167	7.65
8	30.5	48	27.1	88	20.4	128	12.9	168	7.56
9	30.5	49	27.0	89	20.2	129	12.7	169	7.47
10	30.4	50	26.8	90	20.0	130	12.6	170	7.38
11	30.4	51	26.7	91	19.8	131	12.4	171	7.30
12	30.4	52	26.5	92	19.6	132	12.2	172	7.21
13	30.3	53	26.4	93	19.4	133	12.1	173	7.13
14	30.3	54	26.3	94	19.2	134	11.9	174	7.05
15	30.2	55	26.1	95	19.0	135	11.7	175	6.97
16	30.2	56	25.9	96	18.8	136	11.5	176	6.89
17	30.1	57	25.8	97	18.7	137	11.4	177	6.81
18	30.1	58	25.6	98	18.5	138	11.2	178	6.73
19	30.0	59	25.5	99	18.3	139	11.0	179	6.66
20	30.0	60	25.3	100	18.1	140	10.9	180	6.59
21	29.9	61	25.2	101	17.9	141	10.7	181	6.51
22	29.8	62	25.0	102	17.7	142	10.6	182	6.44
23	29.8	63	24.8	103	17.5	143	10.4	183	6.37
24	26.7	64	24.7	104	17.3	144	10.3	184	6.30
25	29.6	65	24.5	105	17.1	145	10.2	185	6.23
26	29.5	66	24.3	106	16.9	146	10.0	186	6.17
27	29.5	67	24.2	107	16.8	147	9.87	187	6.10
28	29.4	68	24.0	108	16.6	148	9.74	188	6.04
29	29.3	69	23.8	109	16.4	149	9.61	189	5.97
30	29.2	70	23.6	110	16.2	150	9.48	190	5.91
31	29.1	71	23.5	111	16.0	151	9.36	191	5.85
32	29.0	72	23.3	112	15.8	152	9.23	192	5.79
33	28.9	73	23.1	113	15.6	153	9.11	193	5.73
34	28.8	74	22.9	114	15.4	154	9.00	194	5.67
35	28.7	75	22.8	115	15.3	155	8.88	195	5.61
36	28.6	76	22.6	116	15.1	156	8.77	196	5.55
37	28.5	77	22.4	117	14.9	157	8.66	197	5.50
38	28.4	78	22.2	118	14.7	158	8.55	198	5.44
39	28.3	79	22.0	119	14.5	159	8.44	199	5.39
40	28.1	80	21.9	120	14.3	160	8.33	200	5.33

[a] When element width-to-thickness ratio exceeds  $\lambda_c$ , see Appendix B5.3.



**TABLE 3-36M**  
**Design Stress for Compression Members of**  
**250 MPa Specified Yield Stress Steel,  $\phi_c = 0.85$ <sup>[a]</sup>**

$\frac{Kl}{r}$	$\phi_c F_{cr}$ MPa	$\frac{Kl}{r}$	$\phi_c F_{cr}$ MPa	$\frac{Kl}{r}$	$\phi_c F_{cr}$ MPa	$\frac{Kl}{r}$	$\phi_c F_{cr}$ MPa	$\frac{Kl}{r}$	$\phi_c F_{cr}$ MPa
1	212	41	194	81	150	121	97.8	161	56.8
2	212	42	194	82	149	122	96.5	162	56.1
3	212	43	193	83	147	123	95.3	163	55.4
4	212	44	192	84	146	124	94.1	164	54.7
5	212	45	191	85	145	125	92.8	165	54.1
6	212	46	190	86	144	126	91.6	166	53.4
7	212	47	189	87	142	127	90.4	167	52.8
8	212	48	188	88	141	128	89.2	168	52.1
9	212	49	187	89	140	129	88.0	169	51.5
10	211	50	186	90	138	130	86.8	170	50.9
11	211	51	185	91	137	131	85.6	171	50.3
12	211	52	184	92	136	132	84.4	172	49.7
13	211	53	183	93	134	133	83.2	173	49.2
14	210	54	182	94	133	134	82.0	174	48.6
15	210	55	181	95	132	135	80.7	175	48.1
16	210	56	180	96	130	136	79.6	176	47.5
17	209	57	179	97	129	137	78.4	177	47.0
18	209	58	178	98	128	138	77.3	178	46.4
19	208	59	177	99	126	139	76.2	179	45.9
20	208	60	176	100	125	140	75.1	180	45.4
21	208	61	174	101	124	141	74.0	181	44.9
22	207	62	173	102	122	142	73.0	182	44.4
23	207	63	172	103	121	143	72.0	183	43.9
24	206	64	171	104	120	144	71.0	184	43.5
25	206	65	170	105	118	145	70.0	185	43.0
26	205	66	169	106	117	146	69.0	186	42.5
27	204	67	168	107	116	147	68.1	187	42.1
28	204	68	166	108	115	148	67.2	188	41.6
29	203	69	165	109	113	149	66.3	189	41.2
30	203	70	164	110	112	150	65.4	190	40.8
31	202	71	163	111	111	151	64.5	191	40.3
32	201	72	161	112	109	152	63.7	192	39.9
33	201	73	160	113	108	153	62.9	193	39.5
34	200	74	159	114	107	154	62.1	194	39.1
35	199	75	158	115	105	155	61.3	195	38.7
36	198	76	156	116	104	156	60.5	196	38.3
37	198	77	155	117	103	157	59.7	197	37.9
38	197	78	154	118	102	158	58.9	198	37.5
39	196	79	153	119	100	159	58.2	199	37.2
40	195	80	151	120	99.1	160	57.5	200	36.8

[a] When element width-to-thickness ratio exceeds  $\lambda_r$ , see Appendix B5.3.

**TABLE 3-50**  
**Design Stress for Compression Members of**  
**50 ksi Specified Yield Stress Steel,  $\phi_c = 0.85$ <sup>[a]</sup>**

$\frac{Kl}{r}$	$\phi_c F_{cr}$ ksi	$\frac{Kl}{r}$	$\phi_c F_{cr}$ ksi	$\frac{Kl}{r}$	$\phi_c F_{cr}$ ksi	$\frac{Kl}{r}$	$\phi_c F_{cr}$ ksi	$\frac{Kl}{r}$	$\phi_c F_{cr}$ ksi
1	42.5	41	37.6	81	26.3	121	14.6	161	8.23
2	42.5	42	37.4	82	26.0	122	14.3	162	8.13
3	42.5	43	37.1	83	25.7	123	14.1	163	8.03
4	42.5	44	36.9	84	25.4	124	13.9	164	7.93
5	42.4	45	36.7	85	25.1	125	13.7	165	7.84
6	42.4	46	36.4	86	24.8	126	13.4	166	7.74
7	42.4	47	36.2	87	24.4	127	13.2	167	7.65
8	42.3	48	35.9	88	24.1	128	13.0	168	7.56
9	42.3	49	35.7	89	23.8	129	12.8	169	7.47
10	42.2	50	35.4	90	23.5	130	12.6	170	7.38
11	42.1	51	35.1	91	23.2	131	12.4	171	7.30
12	42.1	52	34.9	92	22.9	132	12.3	172	7.21
13	42.0	53	34.6	93	22.6	133	12.1	173	7.13
14	41.9	54	34.3	94	22.3	134	11.9	174	7.05
15	41.8	55	34.1	95	22.0	135	11.7	175	6.97
16	41.7	56	33.8	96	21.7	136	11.5	176	6.89
17	41.6	57	33.5	97	21.4	137	11.4	177	6.81
18	41.5	58	33.2	98	21.1	138	11.2	178	6.73
19	41.4	59	33.0	99	20.8	139	11.0	179	6.66
20	41.3	60	32.7	100	20.5	140	10.9	180	6.59
21	41.2	61	32.4	101	20.2	141	10.7	181	6.51
22	41.0	62	32.1	102	19.9	142	10.6	182	6.44
23	40.9	63	31.8	103	19.6	143	10.4	183	6.37
24	40.8	64	31.5	104	19.3	144	10.3	184	6.30
25	40.6	65	31.2	105	19.0	145	10.2	185	6.23
26	40.5	66	30.9	106	18.7	146	10.0	186	6.17
27	40.3	67	30.6	107	18.4	147	9.87	187	6.10
28	40.1	68	30.3	108	18.1	148	9.74	188	6.04
29	40.0	69	30.0	109	17.8	149	9.61	189	5.97
30	39.8	70	29.7	110	17.6	150	9.48	190	5.91
31	39.6	71	29.4	111	17.3	151	9.36	191	5.85
32	39.4	72	29.1	112	17.0	152	9.23	192	5.79
33	39.3	73	28.8	113	16.7	153	9.11	193	5.73
34	39.1	74	28.5	114	16.4	154	9.00	194	5.67
35	38.9	75	28.2	115	16.1	155	8.88	195	5.61
36	38.7	76	27.9	116	15.9	156	8.77	196	5.55
37	38.5	77	27.6	117	15.6	157	8.66	197	5.50
38	38.2	78	27.2	118	15.3	158	8.55	198	5.44
39	38.0	79	26.9	119	15.1	159	8.44	199	5.39
40	37.8	80	26.6	120	14.8	160	8.33	200	5.33

[a] When element width-to-thickness ratio exceeds  $\lambda_c$ , see Appendix B5.3.

**TABLE 3-50M**  
**Design Stress for Compression Members of**  
**345 MPa Specified Yield Stress Steel,  $\phi_c = 0.85$ <sup>[a]</sup>**

$\frac{Kl}{r}$	$\phi_c F_{cr}$ MPa	$\frac{Kl}{r}$	$\phi_c F_{cr}$ MPa	$\frac{Kl}{r}$	$\phi_c F_{cr}$ MPa	$\frac{Kl}{r}$	$\phi_c F_{cr}$ MPa	$\frac{Kl}{r}$	$\phi_c F_{cr}$ MPa
1	293	41	259	81	181	121	101	161	56.8
2	293	42	258	82	179	122	98.9	162	56.1
3	293	43	256	83	177	123	97.3	163	55.4
4	293	44	255	84	175	124	95.7	164	54.7
5	293	45	253	85	173	125	94.2	165	54.1
6	292	46	251	86	171	126	92.7	166	53.4
7	292	47	249	87	169	127	91.2	167	52.8
8	292	48	248	88	166	128	89.8	168	52.1
9	292	49	246	89	164	129	88.4	169	51.5
10	291	50	244	90	162	130	87.1	170	50.9
11	291	51	242	91	160	131	85.7	171	50.3
12	290	52	241	92	158	132	84.5	172	49.7
13	290	53	239	93	156	133	83.2	173	49.2
14	289	54	237	94	154	134	82.0	174	48.6
15	288	55	235	95	152	135	80.7	175	48.1
16	288	56	233	96	149	136	79.6	176	47.5
17	287	57	231	97	147	137	78.4	177	47.0
18	286	58	229	98	145	138	77.3	178	46.4
19	286	59	227	99	143	139	76.2	179	45.9
20	285	60	225	100	141	140	75.1	180	45.4
21	284	61	223	101	139	141	74.0	181	44.9
22	283	62	221	102	137	142	73.0	182	44.4
23	282	63	219	103	135	143	72.0	183	43.9
24	281	64	217	104	133	144	71.0	184	43.5
25	280	65	215	105	131	145	70.0	185	43.0
26	279	66	213	106	129	146	69.0	186	42.5
27	278	67	211	107	127	147	68.1	187	42.1
28	277	68	209	108	125	148	67.2	188	41.6
29	276	69	207	109	123	149	66.3	189	41.2
30	275	70	205	110	121	150	65.4	190	40.8
31	273	71	203	111	119	151	64.5	191	40.3
32	272	72	201	112	117	152	63.7	192	39.9
33	271	73	199	113	115	153	62.9	193	39.5
34	269	74	196	114	113	154	62.1	194	39.1
35	268	75	194	115	111	155	61.3	195	38.7
36	267	76	192	116	109	156	60.5	196	38.3
37	265	77	190	117	107	157	59.7	197	37.9
38	264	78	188	118	106	158	58.9	198	37.5
39	262	79	186	119	104	159	58.2	199	37.2
40	261	80	184	120	102	160	57.5	200	36.8

[a] When element width-to-thickness ratio exceeds  $\lambda_r$ , see Appendix B5.3.

**TABLE 4**  
**Values of  $\phi_c F_{cr} / F_y$ ,  $\phi_c = 0.85$**   
**for Determining Design Stress for Compression**  
**Members for Steel of Any Yield Stress<sup>[a]</sup>**

$\lambda_c$	$\phi_c F_{cr} / F_y$	$\lambda_c$	$\phi_c F_{cr} / F_y$	$\lambda_c$	$\phi_c F_{cr} / F_y$	$\lambda_c$	$\phi_c F_{cr} / F_y$
0.02	0.850	0.82	0.641	1.62	0.284	2.42	0.127
0.04	0.849	0.84	0.632	1.64	0.277	2.44	0.125
0.06	0.849	0.86	0.623	1.66	0.271	2.46	0.123
0.08	0.848	0.88	0.614	1.68	0.264	2.48	0.121
0.10	0.846	0.90	0.605	1.70	0.258	2.50	0.119
0.12	0.845	0.92	0.596	1.72	0.252	2.52	0.117
1.04	0.843	0.94	0.587	1.74	0.246	2.54	0.116
0.16	0.841	0.96	0.578	1.76	0.241	2.56	0.114
0.18	0.839	0.98	0.568	1.78	0.235	2.58	0.112
0.20	0.836	1.00	0.559	1.80	0.230	2.60	0.110
0.22	0.833	1.02	0.550	1.82	0.225	2.62	0.109
0.24	0.830	1.04	0.540	1.84	0.220	2.64	0.107
0.26	0.826	1.06	0.531	1.86	0.215	2.66	0.105
0.28	0.823	1.08	0.521	1.88	0.211	2.68	0.104
0.30	0.819	1.10	0.512	1.90	0.206	2.70	0.102
0.32	0.814	1.12	0.503	1.92	0.202	2.72	0.101
0.34	0.810	1.14	0.493	1.94	0.198	2.74	0.099
0.36	0.805	1.16	0.484	1.96	0.194	2.76	0.098
0.38	0.800	1.18	0.474	1.98	0.190	2.78	0.096
0.40	0.795	1.20	0.465	2.00	0.186	2.80	0.095
0.42	0.789	1.22	0.456	2.02	0.183	2.82	0.094
0.44	0.784	1.24	0.446	2.04	0.179	2.84	0.092
0.46	0.778	1.26	0.437	2.06	0.176	2.86	0.091
0.48	0.772	1.28	0.428	2.08	0.172	2.88	0.090
0.50	0.765	1.30	0.419	2.10	0.169	2.90	0.089
0.52	0.759	1.32	0.410	2.12	0.166	2.92	0.087
0.54	0.752	1.34	0.401	2.14	0.163	2.94	0.086
0.56	0.745	1.36	0.392	2.16	0.160	2.96	0.085
0.58	0.738	1.38	0.383	2.18	0.157	2.98	0.084
0.60	0.731	1.40	0.374	2.20	0.154	3.00	0.083
0.62	0.724	1.42	0.365	2.22	0.151	3.02	0.082
0.64	0.716	1.44	0.357	2.24	0.149	3.04	0.081
0.66	0.708	1.46	0.348	2.26	0.146	3.06	0.080
0.68	0.700	1.48	0.339	2.28	0.143	3.08	0.079
0.70	0.692	1.50	0.331	2.30	0.141	3.10	0.078
0.72	0.684	1.52	0.323	2.32	0.138	3.12	0.077
0.74	0.676	1.54	0.314	2.34	0.136	3.14	0.076
0.76	0.667	1.56	0.306	2.36	0.134	3.16	0.075
0.78	0.659	1.58	0.299	2.38	0.132	3.18	0.074
0.80	0.650	1.60	0.291	2.40	0.129	3.20	0.073

[a] When element width-to-thickness ratios exceed  $\lambda_r$ , see Appendix B5.3

Values of  $\lambda_c > 2.24$  exceed  $Kl / r$  of 200 for  $F_y = 36$  ksi (250 MPa)

Values of  $\lambda_c > 2.64$  exceed  $Kl / r$  of 200 for  $F_y = 50$  ksi (345 MPa)

**TABLE 5**  
**Values of  $Kl / r$  for  $F_y = 36$  and 50 ksi\***

$\lambda_c$	$Kl / r$		$\lambda_c$	$Kl / r$	
	$F_y = 36$	$F_y = 50$		$F_y = 36$	$F_y = 50$
0.02	1.8	1.5	0.82	73.1	62.0
0.04	3.6	3.0	0.84	74.9	63.6
0.06	5.3	4.5	0.86	76.7	65.1
0.08	7.1	6.1	0.88	78.5	66.6
0.10	8.9	7.6	0.90	80.2	68.1
0.12	10.7	9.1	0.92	82.0	69.6
0.14	12.5	10.6	0.94	83.8	71.1
0.16	14.3	12.1	0.96	85.6	72.6
0.18	16.0	13.6	0.98	87.4	74.1
0.20	17.8	15.1	1.00	89.2	75.7
0.22	19.6	16.6	1.02	90.9	77.2
0.24	21.4	18.2	1.04	92.7	78.7
0.26	23.2	19.7	1.06	94.5	80.2
0.28	25.0	21.2	1.08	96.3	81.7
0.30	26.7	22.7	1.10	98.1	83.2
0.32	28.5	24.2	1.12	99.9	84.7
0.34	30.3	25.7	1.14	102	86.3
0.36	32.1	27.2	1.16	103	87.8
0.38	33.9	28.8	1.18	106	89.3
0.40	35.7	30.3	1.20	107	90.8
0.42	37.4	31.8	1.22	109	92.3
0.44	39.2	33.3	1.24	111	93.8
0.46	41.0	34.8	1.26	112	95.3
0.48	42.8	36.3	1.28	114	96.8
0.50	44.6	37.8	1.30	116	98.4
0.52	46.4	39.3	1.32	118	99.9
0.54	48.1	40.9	1.34	120	101
0.56	49.9	42.4	1.36	121	103
0.58	51.7	43.9	1.38	123	104
0.60	53.5	45.4	1.40	125	106
0.62	55.3	46.9	1.42	127	107
0.64	57.1	48.4	1.44	128	109
0.66	58.8	49.9	1.46	130	111
0.68	60.6	51.4	1.48	132	112
0.70	62.4	53.0	1.50	134	114
0.72	64.2	54.5	1.52	136	115
0.74	66.0	56.0	1.54	137	117
0.76	67.8	57.5	1.56	139	118
0.78	69.5	59.0	1.58	141	120
0.80	71.3	60.5	1.60	143	121

\* Note: Calculated values are based on U.S. customary units. Metric units give values within 1 percent of those listed.

**TABLE 5 (cont'd)**  
**Values of  $Kl / r$  for  $F_y = 36$  and 50 ksi\***

$\lambda_c$	$Kl / r$		$\lambda_c$	$Kl / r$
	$F_y = 36$	$F_y = 50$		$F_y = 50$
1.62	144	122	2.42	183
1.64	146	124	2.44	185
1.66	148	126	2.46	186
1.68	150	127	2.48	188
1.70	152	129	2.50	189
1.72	153	130	2.52	191
1.74	155	132	2.54	192
1.76	157	133	2.56	194
1.78	159	135	2.58	195
1.80	161	136	2.60	197
1.82	162	138	2.62	198
1.84	164	139	2.64	200
1.86	166	141		
1.88	168	142		
1.90	169	144		
1.92	171	145		
1.94	173	147		
1.96	175	148		
1.98	177	150		
2.00	178	151		
2.02	180	153		
2.04	182	154		
2.06	184	156		
2.08	186	157		
2.10	187	159		
2.12	189	160		
2.14	191	162		
2.16	193	163		
2.18	194	165		
2.20	196	167		
2.22	198	168		
2.24	200	170		
2.26		171		
2.28		173		
2.30		174		
2.32		176		
2.34		177		
2.36		179		
2.38		180		
2.40		182		

Heavy line indicates  $Kl / r$  of 200.

\* Note: Calculated values are based on U.S. customary units. Metric units give values within 1 percent of those listed.

**TABLE 6**  
**Slenderness Ratios of Elements as a Function of  $F_y$**   
**From Table B5.1\***

Ratio	$F_y$ , ksi (MPa)					
	36 (250)	42 (290)	46 (317)	50 (345)	60 (415)	65 (450)
$0.38\sqrt{E/F_y}$	10.8	9.99	9.54	9.15	8.35	8.03
$0.45\sqrt{E/F_y}$	12.8	11.8	11.3	10.8	9.89	9.51
$0.56\sqrt{E/F_y}$	15.9	14.7	14.1	13.5	12.3	11.8
$0.75\sqrt{E/F_y}$	21.3	19.7	18.8	18.1	16.5	15.8
$1.12\sqrt{E/F_y}$	31.8	29.4	28.1	27.0	24.6	23.7
$1.40\sqrt{E/F_y}$	39.7	36.8	35.2	33.7	30.8	29.6
$1.49\sqrt{E/F_y}$	42.3	39.2	37.4	35.9	32.8	31.5
$1.86\sqrt{E/F_y}$	52.8	48.9	46.7	44.8	40.9	39.3
$3.76\sqrt{E/F_y}$	107	98.8	94.4	90.6	82.7	79.4
$5.70\sqrt{E/F_y}$	162	150	143	137	125	120
$0.045E / F_y$	36.3	31.0	28.4	26.1	21.8	20.0
$0.07E / F_y$	56.4	48.3	44.1	40.6	33.8	31.2
$0.11E / F_y$	88.6	76.0	69.3	63.8	53.2	49.1
$0.31E / F_y$	250	214	195	180	150	138

\* Note: Calculated values are based on U.S. Customary Units. Metric units give values within 1 percent of those listed.  
 $E = 29,000$  ksi (200 000 MPa)

**TABLE 7**  
**Values of  $C_m$**   
**for Use in Section C1**

$\frac{M_1}{M_2}$	$C_m$	$\frac{M_1}{M_2}$	$C_m$	$\frac{M_1}{M_2}$	$C_m$
-1.00	1.00	-0.45	0.78	0.10	0.56
-0.95	0.98	-0.40	0.76	0.15	0.54
-0.90	0.96	-0.35	0.74	0.20	0.52
-0.85	0.94	-0.30	0.72	0.25	0.50
-0.80	0.92	-0.25	0.70	0.30	0.48
-0.75	0.90	-0.20	0.68	0.35	0.46
-0.70	0.88	-0.15	0.66	0.40	0.44
-0.65	0.86	-0.10	0.64	0.45	0.42
-0.60	0.84	-0.05	0.62	0.50	0.40
				0.60	0.36
-0.55	0.82	0	0.60	0.80	0.28
-0.50	0.80	0.05	0.58	1.00	0.20

Note 1:  $C_m = 0.6 - 0.4 (M_1 / M_2)$

Note 2:  $M_1 / M_2$  is positive for reverse curvature and negative for single curvature.  $|M_1| \leq |M_2|$



<b>TABLE 8-36</b> $\frac{\phi_v V_n}{A_w}$ (ksi) for Plate Girders by Appendix F2 for 36 ksi Yield Stress Steel, Tension Field Action Not Included														
$\frac{h}{t_w}$	Aspect ratio $a/h$ : Stiffener Spacing to Web Depth													
	0.5	0.6	0.7	0.8	0.9	1.0	1.2	1.4	1.6	1.8	2.0	2.5	3.0	Over 3.0
60	19.4	19.4	19.4	19.4	19.4	19.4	19.4	19.4	19.4	19.4	19.4	19.4	19.4	19.4
70	19.4	19.4	19.4	19.4	19.4	19.4	19.4	19.4	19.4	19.4	19.4	19.4	19.4	19.4
80	19.4	19.4	19.4	19.4	19.4	19.4	19.4	19.4	19.4	19.4	18.9	18.2	17.9	16.9
90	19.4	19.4	19.4	19.4	19.4	19.4	19.4	18.5	17.8	17.2	16.8	16.2	15.9	14.7
100	19.4	19.4	19.4	19.4	19.4	19.2	17.6	16.6	16.0	15.5	14.9	13.8	13.2	11.9
110	19.4	19.4	19.4	19.4	18.4	17.4	16.0	14.8	13.7	12.8	12.3	11.4	10.9	9.8
120	19.4	19.4	19.4	18.1	16.9	16.0	14.0	12.5	11.5	10.8	10.8	10.3	9.6	9.2
130	19.4	19.4	18.2	16.7	15.6	14.1	11.9	10.6	9.8	9.2	8.8	8.2	7.8	7.0
140	19.4	18.8	16.9	15.5	13.5	12.1	10.3	9.2	8.4	7.9	7.6	7.0	6.7	6.1
150	19.4	17.6	15.7	13.5	11.8	10.6	8.9	8.0	7.3	6.9	6.6	6.1	5.9	5.3
160	18.9	16.5	14.1	11.9	10.4	9.3	7.9	7.0	6.5	6.1	5.8	5.4		4.6
170	17.8	15.5	12.5	10.5	9.2	8.2	7.0	6.2	5.7	5.4	5.1			4.1
180	16.8	13.9	11.1	9.4	8.2	7.3	6.2	5.5	5.1	4.8	4.6			3.7
200	14.9	11.2	9.0	7.6	6.6	5.9	5.0	4.5	4.1					3.0
220	12.3	9.3	7.5	6.3	5.5	4.9	4.2							2.5
240	10.3	7.8	6.3	5.3	4.6	4.1								2.1
260	8.8	6.6	5.3	4.5	3.9	3.5								1.8
280	7.6	5.7	4.6	3.9										
300	6.6	5.0	4.0											
320	5.8	4.4												

**TABLE 8-36 M**  
 $\frac{\phi_v V_n}{A_w}$  (MPa) for Plate Girders by Appendix F2  
 for 250 MPa Yield Stress Steel,  
 Tension Field Action Not Included

$\frac{h}{t_w}$	Aspect ratio $a/h$ : Stiffener Spacing to Web Depth													
	0.5	0.6	0.7	0.8	0.9	1.0	1.2	1.4	1.6	1.8	2.0	2.5	3.0	Over 3.0
60	135	135	135	135	135	135	135	135	135	135	135	135	135	135
70	135	135	135	135	135	135	135	135	135	135	135	135	135	134
80	135	135	135	135	135	135	135	135	135	134	131	126	124	117
90	135	135	135	135	135	135	135	128	123	119	117	112	110	101
100	135	135	135	135	135	133	122	115	111	107	102	95.0	91.0	81.9
110	135	135	135	135	128	121	111	102	94.1	88.6	84.6	78.5	75.2	67.7
120	135	135	135	125	117	111	96.4	85.9	79.1	74.4	71.1	66.0	63.2	56.9
130	135	135	126	116	108	96.9	82.1	73.2	67.4	63.4	60.6	56.2	53.8	48.5
140	135	130	117	107	93.4	83.6	70.8	63.1	58.1	54.7	52.2	48.5	46.4	41.8
150	135	122	109	93.3	81.3	72.8	61.7	55.0	50.6	47.6	45.5	42.2	40.4	36.4
160	131	114	97.3	82.0	71.5	64.0	54.2	48.3	44.5	41.9	40.0	37.1		32.0
170	124	107	86.2	72.6	63.3	56.7	48.0	42.8	39.4	37.1	35.4			28.3
180	117	95.5	76.9	64.8	56.5	50.6	42.8	38.2	35.2	33.1	31.6			25.3
200	102	77.3	62.3	52.5	45.8	41.0	34.7	30.9	28.5					20.5
220	84.6	63.9	51.5	43.4	37.8	33.8	28.7							16.9
240	71.1	53.7	43.2	36.4	31.8	28.4								14.2
260	60.6	45.8	36.8	31.0	27.1	24.2								12.1
280	52.2	39.5	31.8	26.8										
300	45.5	34.4	27.7											
320	40.0	30.2												

**TABLE 8-50**  
 $\frac{\phi_v V_n}{A_w}$  (ksi) for Plate Girders by Appendix F2  
 for 50 ksi Yield Stress Steel,  
 Tension Field Action Not Included

$\frac{h}{t_w}$	Aspect ratio $a/h$ : Stiffener Spacing to Web Depth													Over 3.0	
	0.5	0.6	0.7	0.8	0.9	1.0	1.2	1.4	1.6	1.8	2.0	2.5	3.0		
60	27.0	27.0	27.0	27.0	27.0	27.0	27.0	27.0	27.0	27.0	27.0	27.0	27.0	27.0	26.6
70	27.0	27.0	27.0	27.0	27.0	27.0	27.0	27.0	26.9	26.1	25.5	24.6	24.0	22.8	
80	27.0	27.0	27.0	27.0	27.0	27.0	26.0	24.5	23.5	22.8	22.3	21.5	20.6	18.6	
90	27.0	27.0	27.0	27.0	26.5	25.1	23.1	21.8	20.4	19.2	18.3	17.0	16.3	14.7	
100	27.0	27.0	27.0	25.6	23.9	22.6	20.1	17.9	16.5	15.5	14.9	13.8	13.2	11.9	
110	27.0	27.0	25.3	23.2	21.7	19.6	16.6	14.8	13.7	12.8	12.3	11.4	10.9	9.8	
120	27.0	25.9	23.2	21.1	18.4	16.5	14.0	12.5	11.5	10.8	10.3	9.6	9.2	8.3	
130	27.0	23.9	21.4	18.0	15.7	14.1	11.9	10.6	9.8	9.2	8.8	8.2	7.8	7.0	
140	25.5	22.2	18.4	15.5	13.5	12.1	10.3	9.2	8.4	7.9	7.6	7.0	6.7	6.1	
150	23.8	19.9	16.1	13.5	11.8	10.6	8.9	8.0	7.3	6.9	6.6	6.1	5.9	5.3	
160	22.3	17.5	14.1	11.9	10.4	9.3	7.9	7.0	6.5	6.1	5.8	5.4		4.6	
170	20.6	15.5	12.5	10.5	9.2	8.2	7.0	6.2	5.7	5.4	5.1			4.1	
180	18.3	13.9	11.1	9.4	8.2	7.3	6.2	5.5	5.1	4.8	4.6			3.7	
200	14.9	11.2	9.0	7.6	6.6	5.9	5.0	4.5	4.1					3.0	
220	12.3	9.3	7.5	6.3	5.5	4.9	4.2							2.5	
240	10.3	7.8	6.3	5.3	4.6	4.1								2.1	
260	8.8	6.6	5.3	4.5	3.9	3.5								1.8	
280	7.6	5.7	4.6	3.9											

**TABLE 8-50 M**  
 $\frac{\phi_v V_n}{A_w}$  (MPa) for Plate Girders by Appendix F2  
 for 345 MPa Yield Stress Steel,  
 Tension Field Action Not Included

$\frac{h}{t_w}$	Aspect ratio $a/h$ : Stiffener Spacing to Web Depth													
	0.5	0.6	0.7	0.8	0.9	1.0	1.2	1.4	1.6	1.8	2.0	2.5	3.0	Over 3.0
60	186	186	186	186	186	186	186	186	186	186	186	186	186	184
70	186	186	186	186	186	186	186	186	186	180	176	170	166	158
80	186	186	186	186	186	186	180	169	163	158	154	148	142	128
90	186	186	186	186	183	173	160	151	141	132	126	117	112	101
100	186	186	186	177	165	156	139	124	114	107	102	95.0	91.0	81.9
110	186	186	175	161	150	135	115	102	94.1	88.6	84.6	78.5	75.2	67.7
120	186	179	160	146	127	114	96.4	85.9	79.1	74.4	71.1	66.0	63.2	56.9
130	186	165	147	124	108	96.9	82.1	73.2	67.4	63.4	60.6	56.2	53.8	48.5
140	176	153	127	107	93.4	83.6	70.8	63.1	58.1	54.7	52.2	48.5	46.4	41.8
150	164	138	111	93.3	81.3	72.8	61.7	55.0	50.6	47.6	45.5	42.2	40.4	36.4
160	154	121	97.3	82.0	71.5	64.0	54.2	48.3	44.5	41.9	40.0	37.1		32.0
170	142	107	86.2	72.6	63.3	56.7	48.0	42.8	39.4	37.1	35.4			28.3
180	126	95.5	76.9	64.8	56.5	50.6	42.8	38.2	35.2	33.1	31.6			25.3
200	102	77.3	62.3	52.5	45.8	41.0	34.7	30.9	28.5					20.5
220	84.6	63.9	51.5	43.4	37.8	33.8	28.7							16.9
240	71.1	53.7	43.2	36.4	31.8	28.4								14.2
260	60.6	45.8	36.8	31.0	27.1	24.2								
280	52.2	39.5	31.8	26.8										

**TABLE 9-36**  
 $\frac{\phi_v V_n}{A_w}$  (ksi) for Plate Girders by Appendix G for  
 36 ksi Yield Stress Steel,  
 Tension Field Action Included<sup>[b]</sup>  
 (Italic values indicate gross area,  
 as percent of  $(h \times t_w)$  required for pairs of  
 intermediate stiffeners of 36 ksi yield stress  
 steel with  $V_u / \phi V_n = 1.0$ )<sup>[a]</sup>

$\frac{h}{t_w}$	Aspect ratio $a/h$ : Stiffener Spacing to Web Depth													Over 3.0 [c]	
	0.5	0.6	0.7	0.8	0.9	1.0	1.2	1.4	1.6	1.8	2.0	2.5	3.0		
60	19.4	19.4	19.4	19.4	19.4	19.4	19.4	19.4	19.4	19.4	19.4	19.4	19.4	19.4	19.4
70	19.4	19.4	19.4	19.4	19.4	19.4	19.4	19.4	19.4	19.4	19.4	19.4	19.4	19.4	19.4
80	19.4	19.4	19.4	19.4	19.4	19.4	19.4	19.4	19.4	19.4	19.4	19.1	18.6	18.3	16.9
90	19.4	19.4	19.4	19.4	19.4	19.4	19.4	19.0	18.5	18.2	17.8	17.3	16.8	14.7	
100	19.4	19.4	19.4	19.4	19.4	19.3	18.6	18.1	17.6	17.2	16.6	15.6	14.9	11.9	
110	19.4	19.4	19.4	19.4	19.1	18.7	17.9	17.2	16.3	15.6	15.1	14.0	13.3	9.8	
120	19.4	19.4	19.4	19.0	18.5	18.1	17.0	16.0	15.1	14.4	13.9	12.8	12.0	8.3	
130	19.4	19.4	19.1	18.6	18.1	17.4	16.1	15.1	14.2	13.5	12.9	11.8	11.0	7.0	
140	19.4	19.3	18.7	18.2	17.4	16.6	15.4	14.4	13.5	12.8	12.2	11.0	10.2	6.1	
150	19.4	19.0	18.4	17.5	16.7	16.0	14.8	13.8	12.9	12.2	11.6	10.4	9.6	5.3	
160	19.3	18.7	17.9	17.0	16.2	15.5	14.3	13.3	12.4	11.7	11.1	9.9		4.6	
170	19.1	18.4	17.4	16.6	15.8	15.1	13.9	12.9	12.0	11.3	10.7	<i>0.3</i>	<i>0.4</i>		4.1
180	18.9	18.0	17.1	16.2	15.5	14.8	13.6	12.6	11.7	11.0	10.4				3.7
				<i>0.2</i>	<i>0.7</i>	<i>1.1</i>	<i>1.3</i>	<i>1.5</i>							
200	18.4	17.3	16.4	15.6	14.9	14.2	13.1	12.0	11.2						3.0
			<i>0.1</i>	<i>0.9</i>	<i>1.4</i>	<i>2.1</i>	<i>2.5</i>	<i>2.8</i>							
220	17.8	16.9	16.0	15.2	14.5	13.8	12.7								2.5
			<i>1.1</i>	<i>2.0</i>	<i>2.6</i>	<i>3.0</i>	<i>3.6</i>								
240	17.4	16.5	15.7	14.9	14.2	13.5									2.1
		<i>1.5</i>	<i>2.7</i>	<i>3.4</i>	<i>3.9</i>	<i>4.3</i>									
260	17.1	16.2	15.4	14.6	14.0	13.3									1.8
	<i>1.3</i>	<i>3.0</i>	<i>4.0</i>	<i>4.6</i>	<i>5.0</i>	<i>5.4</i>									
280	16.8	16.0	15.2	14.4											
	<i>2.7</i>	<i>4.2</i>	<i>5.0</i>	<i>5.6</i>											

**TABLE 9-36 (cont'd)**  
 $\frac{\phi_v V_n}{A_w}$  (ksi) for Plate Girders by Appendix G  
 for 36 ksi Yield Stress Steel,  
 Tension Field Action Included<sup>[b]</sup>

(Italic values indicate gross area,  
 as percent of  $(h \times t_w)$  required for pairs of  
 intermediate stiffeners of 36 ksi yield stress  
 steel with  $V_u / \phi V_n = 1.0$ )<sup>[a]</sup>

$\frac{h}{t_w}$	<b>Aspect ratio <math>a/h</math> : Stiffener Spacing to Web Depth</b>													<b>Over 3.0 [c]</b>
	0.5	0.6	0.7	0.8	0.9	1.0	1.2	1.4	1.6	1.8	2.0	2.5	3.0	
300	16.6	15.8	15.0											
	<i>3.9</i>	<i>5.2</i>	<i>5.9</i>											
320	16.4	15.6												
	<i>4.9</i>	<i>6.0</i>												

[a] For area of single-angle and single-plate stiffeners, or when  $V_u / \phi V_n < 1.0$ , see Equation A-G4-1.

[b] For end-panels and all panels in hybrid and web-tapered plate girders, use Table 9-36.

[c] Same as for Table 9-36.

Note: Girders so proportioned that the computed shear is less than that given in the right-hand column do not require intermediate stiffeners.

**TABLE 9-36 M**  
 $\frac{\phi_v V_n}{A_w}$  (MPa) for Plate Girders by Appendix G  
 for 250 MPa Yield Stress Steel,  
 Tension Field Action Included<sup>[b]</sup>  
 (Italic values indicate gross area,  
 as percent of  $(h \times t_w)$  required for pairs of  
 intermediate stiffeners of 250 MPa yield stress  
 steel with  $V_u / \phi V_n = 1.0$ )<sup>[a]</sup>

$\frac{h}{t_w}$	Aspect ratio $a / h$ : Stiffener Spacing to Web Depth													Over 3.0 [c]
	0.5	0.6	0.7	0.8	0.9	1.0	1.2	1.4	1.6	1.8	2.0	2.5	3.0	
60	135	135	135	135	135	135	135	135	135	135	135	135	135	135
70	135	135	135	135	135	135	135	135	135	135	135	135	135	134
80	135	135	135	135	135	135	135	135	135	135	133	129	127	117
90	135	135	135	135	135	135	135	132	129	126	124	120	117	101
100	135	135	135	135	135	134	129	125	122	119	115	108	103	81.9
110	135	135	135	135	132	130	124	119	113	108	104	96.9	91.8	67.7
120	135	135	135	132	129	126	118	111	105	100	96.0	88.4	83.0	56.9
130	135	135	132	129	126	120	112	105	98.6	93.7	89.6	81.7	76.2	48.5
140	135	134	130	126	120	115	107	99.5	93.6	88.7	84.5	76.5	70.9	41.8
150	135	132	128	122	116	111	103	95.5	89.6	84.6	80.4	72.2	66.5	36.4
160	134	130	124	118	113	108	99.2	92.2	86.3	81.2	77.0	68.8		32.0
170	132	128	121	115	110	105	96.5	89.4	83.5	78.5 0.3	74.2 0.4			28.3
180	131	125	118	113	107	103	94.2 0.2	87.2 0.7	81.2 1.1	76.2 1.3	71.9 1.5			25.3
200	128	120	114	109 0.1	103 0.9	98.8 1.4	90.6 2.1	83.6 2.5	77.6 2.8					20.5
220	124	117	111 1.1	106 2.0	101 2.6	96.1 3.0	87.9 3.6							16.9
240	121	114 1.5	109 2.7	103 3.4	98.5 3.9	94.0 4.3								14.2
260	118 1.3	112 3.0	107 4.0	102 4.6	96.9 5.0	92.4 5.4								12.1
280	117 2.7	111 4.2	105 5.0	100 5.6										

**TABLE 9-36 M (cont'd)**  
 $\frac{\phi_v V_n}{A_w}$  (MPa) for Plate Girders by Appendix G  
 for 250 MPa Yield Stress Steel,  
 Tension Field Action Included<sup>[b]</sup>

(Italic values indicate gross area,  
 as percent of  $(h \times t_w)$  required for pairs of  
 intermediate stiffeners of 250 MPa yield stress  
 steel with  $V_u / \phi V_n = 1.0$ )<sup>[a]</sup>

$\frac{h}{t_w}$	Aspect ratio $a/h$ : Stiffener Spacing to Web Depth													Over 3.0 [c]
	0.5	0.6	0.7	0.8	0.9	1.0	1.2	1.4	1.6	1.8	2.0	2.5	3.0	
300	115 <i>3.9</i>	109 <i>5.2</i>	104 <i>5.9</i>											
320	114 <i>4.9</i>	108 <i>6.0</i>												

[a] For area of single-angle and single-plate stiffeners, or when  $V_u / \phi V_n < 10$ , see Equation A-G4-1.

[b] For end-panels and all panels in hybrid and web-tapered plate girders, use Table 9-36M.

[c] Same as for Table 9-36M.

Note: Girders so proportioned that the computed shear is less than that given in the right-hand column do not require intermediate stiffeners.



**TABLE 9-50**  
 $\frac{\phi_v V_n}{A_w}$  (ksi) for Plate Girders by Appendix G  
 for 50 ksi Yield Stress Steel,  
 Tension Field Action Included <sup>[b]</sup>  
 (Italic values indicate gross area, as percent of  $(h \times t_w)$   
 required for pairs of intermediate stiffeners of 50 ksi  
 yield stress steel with  $V_u / \phi V_n = 1.0$ ) <sup>[a]</sup>

$\frac{h}{t_w}$	Aspect ratio $a/h$ : Stiffener Spacing to Web Depth													Over 3.0 [c]	
	0.5	0.6	0.7	0.8	0.9	1.0	1.2	1.4	1.6	1.8	2.0	2.5	3.0		
60	27.0	27.0	27.0	27.0	27.0	27.0	27.0	27.0	27.0	27.0	27.0	27.0	27.0	27.0	26.6
70	27.0	27.0	27.0	27.0	27.0	27.0	27.0	27.0	26.9	26.5	26.1	25.4	24.9	22.8	
80	27.0	27.0	27.0	27.0	27.0	27.0	26.5	25.8	25.1	24.6	24.1	23.3	22.4	18.6	
90	27.0	27.0	27.0	27.0	26.8	26.3	25.3	24.4	23.4	22.5	21.7	20.2	19.2	14.7	
100	27.0	27.0	27.0	26.5	25.9	25.3	24.0	22.5	21.4	20.4	19.6	18.0	17.0	11.9	
110	27.0	27.0	26.5	25.8	25.1	24.2	22.4	21.0	19.8	18.8	18.0	16.4	15.3	9.8	
120	27.0	26.7	25.9	25.1	24.0	23.0	21.2	19.8	18.6	17.6	16.8	15.2	14.1	8.3	
130	27.0	26.2	25.4	24.1	23.0	22.0	20.3	18.9	17.7	16.7	15.9	14.2	13.1	7.0	
140	26.7	25.8	24.5	23.3	22.2	21.3	19.6	18.2	17.0	16.0	15.1	13.5	12.3	6.1	
150	26.3	25.2	23.9	22.7	21.6	20.7	19.0	17.6	16.4	15.4	14.5	12.9	11.7	5.3	
160	26.0	24.6	23.3	22.2	21.1	20.2	18.5	17.1	15.9	14.9	14.0	12.4		4.6	
170	25.6	24.1	22.8	21.7	20.7	19.8	18.1	16.7	15.2	14.5	13.6			4.1	
180	25.1	23.7	22.4	21.3	20.3	19.4	17.8	16.4	15.2	14.2	13.3			3.7	
200	24.3	23.0	21.8	20.8	19.8	18.9	17.3	15.9	14.7					3.0	
220	23.7	22.5	21.1	20.4	19.4	18.5	16.9							2.5	
240	23.2	22.1	21.0	20.0	19.1	18.2								2.1	
260	23.0	21.8	20.8	19.8	18.8	18.0									
280	22.7	21.6	20.6	19.6											

[a] For area of single-angle and single-plate stiffeners, or when  $V_u / \phi V_n < 1.0$ , see Equation A-G4-1.

[b] For end-panels and all panels in hybrid and web-tapered plate girders, use Table 9-50.

[c] Same as for Table 9-50.

Note: Girders so proportioned that the computed shear is less than that given in the right-hand column do not require intermediate stiffeners.

**TABLE 9-50 M**  
 $\frac{\phi_v V_n}{A_w}$  (MPa) for Plate Girders by Appendix G  
 for 345 MPa Yield Stress Steel,  
 Tension Field Action Included<sup>[b]</sup>  
 (Italic values indicate gross area, as percent of  $(h \times t_w)$   
 required for pairs of intermediate stiffeners of 345 MPa  
 yield stress steel with  $V_u / \phi V_n = 1.0$ )<sup>[a]</sup>

$\frac{h}{t_w}$	Aspect ratio $a/h$ : Stiffener Spacing to Web Depth													Over 3.0 [c]
	0.5	0.6	0.7	0.8	0.9	1.0	1.2	1.4	1.6	1.8	2.0	2.5	3.0	
60	186	186	186	186	186	186	186	186	186	186	186	186	186	184
70	186	186	186	186	186	186	186	186	186	186	183	180	175	158
80	186	186	186	186	186	186	183	178	174	170	167	161	155	128
90	186	186	186	186	185	181	174	169	162	155	150	140	133	101
100	186	186	186	183	179	175	165	155	147	141	135	125	117	81.9
110	186	186	183	178	173	167	155	145	137	130	124	113	106	67.7
120	186	184	179	173	165	158	147	137	129	122	116	105	97.1	56.9
130	186	181	175	166	159	152	140	130	122	115	110	98.3	90.4	48.5
140	184	178	169	161	154	147	135	125	117	110	104	93.1	85.0	41.8
150	181	174	165	157	149	143	131	121	113	106	100	88.8	80.6	36.4
160	179	170	161	153	146	139	128	118	110	103	96.9	85.3		32.0
									0.2	0.4	0.5	0.8		
170	176	166	158	150	143	136	125	115	107	100	94.1			28.3
							0.5	1.0	1.2	1.4	1.6			
180	173	163	155	147	140	134	123	113	105	97.8	91.8			25.3
					0.4	0.9	1.5	1.9	2.2	2.3	2.5			
200	168	159	151	143	137	130	119	109	101					20.5
			1.0	1.8	2.3	2.7	3.2	3.5	3.7					
220	164	155	148	140	134	128	116							16.9
		1.7	2.7	3.3	3.8	4.1	4.5							
240	161	153	145	138	132	126								14.2
	1.8	3.2	4.0	4.6	4.9	5.2								
260	158	151	143	136	130	124								
	3.2	4.4	5.1	5.6	5.9	6.1								
280	157	149	142	135										
	4.4	5.4	6.0	6.4										

[a] For area of single-angle and single-plate stiffeners, or when  $V_u / \phi V_n < 1.0$ , see Appendix A-G4-1.

[b] For end-panels and all panels in hybrid and web-tapered plate girders, use Table 8-50M.

[c] Same as for Table 8-50M.

Note: Girders so proportioned that the computed shear is less than that given in the right-hand column do not require intermediate stiffeners.

**TABLE 10**  
**Nominal Horizontal Shear Load for**  
**One Connector  $Q_n$ , kips <sup>[a]</sup>**  
**From Equations I5-1 and I5-2**

Connector [b]	Specified Compressive Strength of concrete $f'_c$ , ksi [d]		
	3.0	3.5	4.0
½-in. dia. × 2-in. hooked or headed stud	9.4	10.5	11.6
⅝-in. dia. × 2½ in. hooked or headed stud	14.6	16.4	18.1
¾-in. dia. × 3-in. hooked or headed stud	21.0	23.6	26.1
⅞-in. dia. × 3½-in. hooked or headed stud	28.6	32.1	35.5
Channel C3 × 4.1	10.2 $L_c$ [c]	11.5 $L_c$ [c]	12.7 $L_c$ [c]
Channel C4 × 5.4	11.1 $L_c$ [c]	12.4 $L_c$ [c]	13.8 $L_c$ [c]
Channel C5 × 6.7	11.9 $L_c$ [c]	13.3 $L_c$ [c]	14.7 $L_c$ [c]

[a] Applicable only to concrete made with ASTM C33 aggregates.  
[b] The nominal horizontal loads tabulated may also be used for studs longer than shown.  
[c]  $L_c$  = length of channel, inches.  
[d]  $F_u > 0.5 (f'_c w)^{0.75}$ ,  $w = 145 \text{ lbs./cu. ft.}$

**TABLE 10 M**  
**Nominal Horizontal Shear Load for**  
**One Connector  $Q_n$ , kN<sup>[a]</sup>**  
**From Equations I5-1 and I5-2**

Connector [b]	Specified Compressive Strength of Concrete, $f'_c$ , MPa [d]		
	20	25	30
12.7 mm dia.x 50 mm hooked or headed stud	42	48	55
15.9 mm dia.x 63 mm hooked or headed stud	65	75	86
19.0 mm dia.x 75 mm hooked or headed stud	93	108	123
22.2 mm dia.x 88 mm hooked or headed stud	127	145	167
Channel C75 x 6.1	1.8 $L_c$ [c]	2.1 $L_c$ [c]	2.4 $L_c$ [c]
Channel C100 x 8	1.9 $L_c$ [c]	2.2 $L_c$ [c]	2.6 $L_c$ [c]
Channel C130 x 10.4	2.1 $L_c$ [c]	2.4 $L_c$ [c]	2.7 $L_c$ [c]

[a] Applicable only to concrete made with ASTM C33 aggregates.  
[b] The nominal horizontal loads tabulated may also be used for studs longer than shown.  
[c]  $L_c$  = length of channel, mm.  
[d]  $F_u > 0.1 (f'_c w)^{0.75}$ ,  $w = 2325 \text{ kg/m}^3$

# COMMENTARY

## on the Load and Resistance Factor Design Specification for Structural Steel Buildings

December 27, 1999

### INTRODUCTION

The Specification is intended to be complete for normal design usage.

The Commentary furnishes background information and references for the benefit of the engineer seeking further understanding of the basis, derivations and limits of the specification.

The Specification and Commentary are intended for use by design professionals with demonstrated engineering competence.

# CHAPTER A

## GENERAL PROVISIONS

### A1. SCOPE

Load and Resistance Factor Design (LRFD) is an improved approach to the design of structural steel for buildings. It involves explicit consideration of limit states, multiple load factors, and resistance factors, and implicit probabilistic determination of reliability. The designation LRFD reflects the concept of factoring both loads and resistance. This type of factoring differs from the AISC allowable stress design (ASD) Specification (AISC, 1989), where only the resistance is divided by a factor of safety (to obtain allowable stress) and from the plastic design portion of that Specification, where only the loads are multiplied by a common load factor. The LRFD method was devised to offer the designer greater flexibility, more rationality, and possible overall economy.

The format of using resistance factors and multiple load factors is not new, as several such design codes are in effect [the ACI-318M Building Code Requirements for Structural Concrete (ACI, 1999) and the AASHTO Load and Resistance Factor Design for Bridges (AASHTO, 1996)]. Nor should the new LRFD method give designs radically different from the older methods, since it was tuned, or “calibrated,” to typical representative designs of the earlier methods. The principal new ingredient is the use of a probabilistic mathematical model in the development of the load and resistance factors, which made it possible to give proper weight to the accuracy with which the various loads and resistances can be determined. Also, it provides a rational methodology for transference of test results into design provisions. A more rational design procedure leading to more uniform reliability is the practical result.

### A2. TYPES OF CONSTRUCTION

*Connection Classification.* In the first edition of the LRFD Specification (AISC, 1986), the types of construction were changed from Type 1 through Type 3 (AISC, 1978) to the more general terms of fully-restrained (FR) and partially restrained (PR), to provide appropriate recognition of connection stiffness. The third edition of the LRFD Specification emphasizes the combined importance of stiffness, strength and ductility in connection design.

Examples of connection classification schemes include those described by Ackroyd and Gerstle (1982), Bjorhovde, Colson, and Brozzetti (1990), and Eurocode 3 (1992) (Leon, 1994). The basic assumption made in classifying connections is that their most important behavioral characteristics can be modeled by a moment-rotation ( $M-\theta$ ) curve such as shown in Figure C-A2.1. Implicit in the moment-rotation curve is the definition of the connection as a region of the connected members, along with the connecting elements. The connection is defined in

this way because the rotation is measured over a gage length that incorporates the contributions of both the connecting elements and the members being connected.

*Connection Strength.* Referring to Figure C-A2.1, it is presumed that the nominal connection strength  $M_n$  can be determined on the basis of an ultimate limit state model of the connection or from test data. Further, many PR connections do not exhibit a plateau in their moment-rotation relationship, even at large rotations. In determining their strength based on tests, it is necessary to assume a rotation at which to define the nominal strength. For this purpose, the connection strength can be defined at a rotation of approximately  $\theta_n=0.02$  radians (Hsieh and Deierlein, 1991, and Leon, Hoffman, and Staeger, 1996).

An important aspect of the nominal strength of a connection,  $M_n$ , is its relationship to the strength of the connected beam  $M_{p,beam}$ . A connection is *full strength* if  $M_n > M_{p,beam}$ , otherwise the connection is *partial strength*.

A partial strength PR connection must be designed with sufficient ductility to permit the connection components to deform and to avoid any brittle failure modes.

It is also useful to define a lower limit for the strength, below which the connection can be treated as simple. Connections that transmit less than  $0.2M_{p,beam}$  at a rotation of 0.02 radians can be considered to have no flexural strength for design. It should be recognized, however, that the aggregate strength of many weak partial strength connections (e.g. those with a capacity less than  $0.2M_{p,beam}$ ) can be significant when compared to that of a few strong connections (FEMA, 1997).

*Connection ductility.* Connection ductility is a key parameter when the deformations are concentrated in the connection elements, as is the typical case in partial strength PR connections. The ductility required will depend on the flexibility of the connections and the particular application. For example, the ductility requirement for a braced frame in a non-seismic area will generally be less than for an unbraced frame in a high seismic area. Referring again to Figure C-A2.1, the rotation capacity,  $\theta_u$ , can be defined as the value of the connection rotation at the point where either (a) the resisting strength of the connection has dropped to  $0.8M_n$ , i.e. to 80 percent of the nominal connection strength, or (b) the connection has deformed beyond a reasonable limit, e.g. 0.03 radians. This second criterion for determining  $\theta_u$  is intended to apply to connections where there is no loss in strength until very large rotations occur. For example, tests of double-angle web connections show that some details will deform in a ductile manner beyond the point where the beam

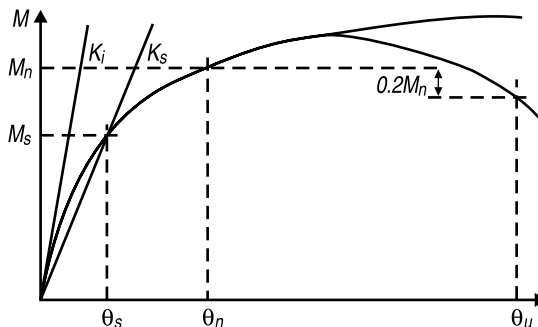

Fig. C-A2.1. Typical moment-rotation response of a partially-restrained connection.

comes into contact with the supporting column. However, it would not be appropriate to rely on these extremely large rotations (typically more than 0.1 radians) for design.

The available ductility,  $\theta_u$ , should be compared with the required rotational ductility under the full factored loads, as determined by an analysis that takes into account the nonlinear behavior of the connection. In the absence of accurate analyses of the required rotation capacity, the connection ductility may be considered adequate when the available ductility is greater than 0.03 radians. This rotation is equal to the minimum beam-to-column connection ductility as specified in the AISC seismic provisions for special moment frames (AISC, 1997 and 1999). Many types of partial strength PR connections, such as top and seat-angle details, meet this criterion.

*Connection Stiffness.* Because many PR connections manifest nonlinear behavior even at low force levels, the initial stiffness of the connection,  $K_i$ , does not characterize the connection response adequately. Short of modeling the nonlinear response, a better measure of behavior is the secant stiffness,  $K_s$  (see Figure C-A2.1). The secant stiffness is defined on the basis of either the moment,  $M_s$ , or the rotation,  $\theta_s$ , that would occur under the applied loads. Generally, two distinct values of secant stiffness should be considered in design, with one corresponding to the behavior under service loads and the other to the behavior under factored loads.

The ratio of connection stiffness to beam stiffness can be defined as  $\alpha = K_s L / EI$ , where  $L$  and  $EI$  are the length and bending rigidity, respectively, of the connected beam. Limiting values of  $\alpha$  are approximate ways of categorizing connection stiffness in order to simplify the analysis. The limits are not exact values, and generally depend on the structural geometry and the limit state used to establish the criterion. For continuous beams in braced frames, for example, limits based on achieving a certain percentage of the fixed-end moment or reaching a deflection limit can be used to establish stiffness criteria (Leon, 1994).

Following such an approach, where  $\alpha$  is defined using the secant stiffness for the serviceability limit state, it is reasonable to classify connections as fully restrained if  $\alpha > 20$ . On the other hand, connections with  $\alpha < 2$  may be approximated as simple.

*Structural Analysis and Design.* When the secant stiffness falls below the fully restrained limit, engineers should account for the PR behavior in determining member and connection forces, displacements, and frame stability effects. This requires, first, that the moment-rotation characteristics of the connection be known, and second, that these characteristics be incorporated in analysis and member design.

Typical moment-rotation curves for many PR connections are available from several databases: Goverdhan (1983); Ang and Morris (1984); Nethercot (1985); and Kishi and Chen (1986), for example. Care should be exercised when utilizing tabulated moment-rotation curves not to extrapolate to sizes or conditions beyond those used to develop the database, since other failure modes may control (ASCE Task Committee on Effective Length, 1997). When the connections to be modeled do not fall within the range of the databases, it is possible to derive the characteristics from tests, simple component modeling, or finite element studies (FEMA, 1995). Examples of how to model connection behavior are given in numerous references (Bjorhovde, Brozzetti, and Colson, 1988; Bjorhovde, Colson, Haaijer, and Stark, 1992; Bjorhovde, Colson, and Zandonini, 1996; Chen and Lui, 1991; Lorenz, Kato,

and Chen, 1993; Chen and Toma, 1994; Chen, Goto, and Liew, 1995; and Leon et al., 1996).

The degree of sophistication of the analysis depends on the problem at hand. Usually design for PR construction requires separate analyses for the serviceability and ultimate limit states. For serviceability, an analysis using linear springs with a secant stiffness  $K_s$  is often sufficient. Under factored loads, a more careful procedure is needed to ensure that the characteristics assumed in the analysis are consistent with those of the connection response. As shown in Figure C-A2.1, the response is especially nonlinear as the applied moment approaches the nominal connection strength,  $M_n$ . In particular, the effect of the connection nonlinearity on second-order moments and other stability checks need to be considered (ASCE Task Committee on Effective Length, 1997). The preferable method of incorporating these effects in the ultimate limit state check is through a second-order analysis that models the nonlinear moment-rotation response of the connections explicitly. Alternatively, for regular structures in regions of low to moderate seismicity, properly calibrated second-order elastic analysis methods or plastic hinge methods (e.g., Leon et al., 1996) can be used. Elastic procedures may, for example, use linear springs with reduced secant-stiffness values determined to be consistent with the maximum rotations calculated under the factored loads.

Prior to this Specification, an analysis procedure was used that ignored the restraining effect of connections for gravity loads. However, the effect was taken into account for lateral load resistance to wind loads. This method was referred to as “simple framing”, and required that three conditions be satisfied (Disque, 1964). Today’s approach of using a predictable degree of connection restraint is a more accurate representation of the structural behavior.

### **A3. MATERIAL**

#### **1. Structural Steel**

##### **1a. ASTM Designations**

The grades of structural steel approved for use under the LRFD Specification, covered by ASTM standard specifications, extend to a yield stress of 100 ksi (690 MPa). Some of these ASTM standards specify a minimum yield point, while others specify a minimum yield strength. The term “yield stress” is used in the Specification as a generic term to denote either the yield point or the yield strength.

It is important to be aware of limitations of availability that may exist for some combinations of strength and size. Not all structural section sizes are included in the various material specifications. For example, the 60 ksi (415 MPa) yield strength steel in the A572/A572M specification includes plate only up to 1¼-in. (32 mm) in thickness. Another limitation on availability is that even when a product is included in the specifications, it may be infrequently produced by the mills. Specifying these products may result in procurement delays or require ordering large quantities directly from the producing mills. Consequently, it is prudent to check availability before completing the details of a design.

Properties in the direction of rolling are of principal interest in the design of steel structures. Hence, yield stress as determined by the standard tensile test is the principal mechanical property recognized in the selection of the steels approved for use



under the Specification. It must be recognized that other mechanical and physical properties of rolled steel, such as anisotropy, ductility, notch toughness, formability, corrosion resistance, etc., may also be important to the satisfactory performance of a structure.

It is not possible to incorporate in the Commentary adequate information to impart full understanding of all factors which might merit consideration in the selection and specification of materials for unique or especially demanding applications. In such a situation the user of the Specification is advised to make use of reference material contained in the literature on the specific properties of concern and to specify supplementary material production or quality requirements as provided for in ASTM material specifications. One such case is the design of highly restrained welded connections (AISC, 1973). Rolled steel is anisotropic, especially insofar as ductility is concerned; therefore, weld contraction strains in the region of highly restrained welded connections may exceed the capabilities of the material if special attention is not given to material selection, details, workmanship, and inspection.

Another special situation is that of fracture control design for certain types of service conditions (AASHTO, 1996). The relatively warm temperatures of steel in buildings, the essentially static strain rates, the stress intensity, and the number of cycles of full design stress make the probability of fracture in building structures extremely remote. Good workmanship and good design details incorporating joint geometry that avoids severe stress concentrations are generally the most effective means of providing fracture-resistant construction. However, for especially demanding service conditions such as low temperatures with impact loading, the specification of steels with superior notch toughness may be warranted.

### **1c. Heavy Shapes**

The web-to-flange intersection and the web center of heavy hot-rolled shapes as well as the interior portions of heavy plates may contain a coarser grain structure and/or lower toughness material than other areas of these products. This is probably caused by ingot segregation, as well as somewhat less deformation during hot rolling, higher finishing temperature, and a slower cooling rate after rolling for these heavy sections. This characteristic is not detrimental to suitability for service for compression members, or for non-welded members.

However, when heavy cross sections are joined by splices or connections using complete-joint-penetration welds which extend through the coarser and/or lower notch-tough interior portions, tensile strains induced by weld shrinkage may result in cracking, for example in a complete-joint-penetration welded connection of a heavy cross section beam to any column section. When members of lesser thickness are joined by complete-joint-penetration welds, which induce smaller weld shrinkage strains, to the finer grained and/or more notch-tough surface material of ASTM A6/A6M Group 4 and 5 shapes and heavy built-up cross sections, the potential for cracking is significantly lower, for example in a complete-joint-penetration groove welded connection of a non-heavy cross-section beam to a heavy cross-section column.

For critical applications such as primary tension members, material should be specified to provide adequate toughness at service temperatures. Because of differences in the strain rate between the Charpy V-notch (CVN) impact test and the strain rate experienced in actual structures, the CVN test is conducted at a temperature higher

than the anticipated service temperature for the structure. The location of the CVN test is shown in Figure C-A3.1.

The toughness requirements of Section A3.1c are intended only to provide material of reasonable toughness for ordinary service applications. For unusual applications and/or low temperature service, more restrictive requirements and/or toughness requirements for other section sizes and thicknesses may be appropriate. To minimize the potential for fracture, the notch toughness requirements of Section A3.1c must be used in conjunction with good design and fabrication procedures. Specific requirements are given in Sections J1.5, J1.6, J2.6, J2.8, and M2.2.

For rotary-straightened W-shapes, an area of reduced notch toughness has been documented in a limited region of the web immediately adjacent to the flange as illustrated in Figure C-A3.2. Preliminary recommendations have been issued (AISC, 1997) and AISC is currently exploring the associated implications for design and construction. It is anticipated that recommendations will be forthcoming, albeit after the publication of this document. For this reason, the reader is encouraged to maintain an awareness of AISC recommendations as they become available.

### 3. Bolts, Washers, and Nuts

The ASTM standard for A307 bolts covers two grades of fasteners. Either grade may be used under the LRFD Specification; however, it should be noted that Gr. B

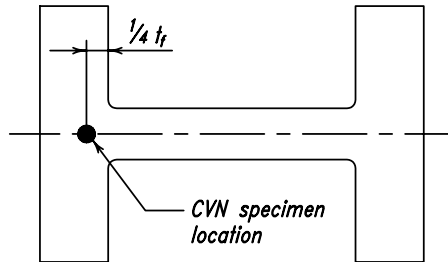

Fig. C-A3.1. Location from which Charpy impact specimen shall be taken.

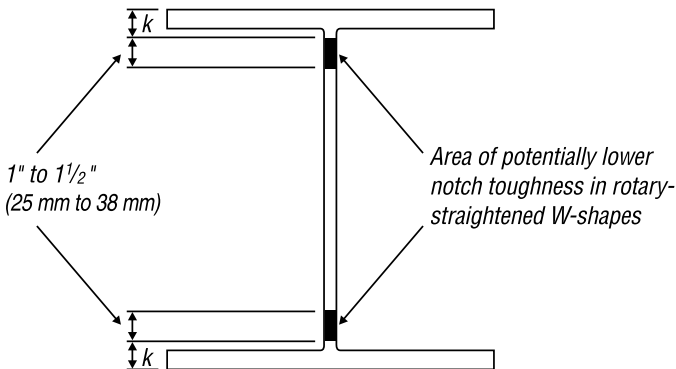

Fig. C-A3.2. "k-area."

is intended for pipe flange bolting and Gr. A is the grade long in use for structural applications.

#### **4. Anchor Rods and Threaded Rods**

Since there is a limit on the maximum available length of A325 or A325M and A490 or A490M bolts, the attempted use of these bolts for anchor rods with design lengths longer than the maximum available lengths has presented problems in the past. The inclusion of A449 and A354 materials in this Specification allows the use of higher strength material for bolts longer than A325 or A325M and A490 or A490M bolts. The designer should be aware that pretensioning of anchor rods is not recommended due to relaxation and the potential for stress corrosion after pretensioning.

The designer should specify the appropriate thread and SAE fit for threaded rods used as load-carrying members.

#### **5. Filler Metal and Flux for Welding**

The filler metal specifications issued by the American Welding Society (AWS) are general specifications which include filler metals suitable for building construction, as well as consumables that would not be suitable for building construction. For example, some electrodes covered by the specifications are specifically limited to single pass applications, while others are restricted to sheet metal applications. Many of the filler metals listed are "low hydrogen," that is, they deposit filler metal with low levels of diffusible hydrogen. Other materials are not. Filler metals listed under the various AWS A5 specifications may or may not have required impact toughness, depending on the specific electrode classification. Section J2.6 has identified certain welded joints where notch toughness of filler metal is needed in building construction. However, on structures subject to dynamic loading, filler metals may be required to deliver notch-tough weld deposits in other joints. Filler metals may be classified in either the as-welded or post weld heat-treated (stress-relieved) condition. Since most structural applications will not involve stress relief, it is important to utilize filler materials that are classified in conditions similar to those experienced by the actual structure.

When specifying filler metal and/or flux by AWS designation, the applicable standard specifications should be carefully reviewed to assure a complete understanding of the designation reference. This is necessary because the AWS designation systems are not consistent. For example, in the case of electrodes for shielded metal arc welding (AWS A5.1), the first two or three digits indicate the nominal tensile strength classification, in ksi, of the filler metal and the final two digits indicate the type of coating. For metric designations, the first two digits times 10 indicate the nominal tensile strength classification in MPa. In the case of mild steel electrodes for submerged arc welding (AWS A5.17), the first one or two digits times 10 indicate the nominal tensile strength classification for both U.S. Customary and metric units, while the final digit or digits times 10 indicate the testing temperature in degrees F (degrees Celsius), for filler metal impact tests. In the case of low-alloy steel covered arc welding electrodes (AWS A5.5), certain portions of the designation indicate a requirement for stress relief, while others indicate no stress relief requirement.

Engineers do not, in general, specify the exact filler metal to be employed on a par-

ticular structure. Rather, the decision as to which welding process and which filler metal is to be utilized is usually left with the fabricator or erector. To ensure that the proper filler metals are used, codes restrict the usage of certain filler materials, or impose qualification testing to prove the suitability of the specific electrode.

#### A4. LOADS AND LOAD COMBINATIONS

The load factors and load combinations are developed in Ellingwood, MacGregor, Galambos, and Cornell (1982) based on the recommended minimum loads given in ASCE 7 (ASCE, 1998).

The load factors and load combinations recognize that when several loads act in combination with the dead load (e.g., dead plus live plus wind), only one of these takes on its maximum lifetime value, while the other load is at its “arbitrary point-in-time value” (i.e., at a value which can be expected to be on the structure at any time). For example, under dead, live, and wind loads the following combinations are appropriate:

$$\gamma_D D + \gamma_L L \quad (\text{C-A4-1})$$

$$\gamma_D D + \gamma_{L_a} L_a + \gamma_W W \quad (\text{C-A4-2})$$

$$\gamma_D D + \gamma_L L + \gamma_{W_a} W_a \quad (\text{C-A4-3})$$

where  $\gamma$  is the appropriate load factor as designated by the subscript symbol. Subscript  $a$  refers to an “arbitrary point-in-time” value.

The mean value of arbitrary point-in-time live load  $L_a$  is on the order of 0.24 to 0.4 times the mean maximum lifetime live load  $L$  for many occupancies, but its dispersion is far greater. The arbitrary point-in-time wind load  $W_a$ , acting in conjunction with the maximum lifetime live load, is the maximum daily wind. It turns out that  $\gamma_{W_a} W_a$  is a negligible quantity so only two load combinations remain:

$$1.2D + 1.6L \quad (\text{C-A4-4})$$

$$1.2D + 0.5L + 1.3W \quad (\text{C-A4-5})$$

The load factor 0.5 assigned to  $L$  in the second formula reflects the statistical properties of  $L_a$ , but to avoid having to calculate yet another load, it is reduced so it can be combined with the maximum lifetime wind load.

The nominal loads  $D$ ,  $L$ ,  $W$ ,  $E$ , and  $S$  are the code loads or the loads given in ASCE 7. The latest edition of the ASCE 7 Standard on structural loads released in 1998 has adopted, in most aspects, the seismic design provisions from NEHRP (1997), as has the AISC *Seismic Provisions for Structural Steel Buildings* (AISC, 1997 and 1999). The reader is referred to the commentaries to these documents for an expanded discussion on seismic loads, load factors, and seismic design of steel buildings.

## A5. DESIGN BASIS

### 1. Required Strength at Factored Loads

LRFD permits the use of both elastic and plastic structural analyses. LRFD provisions result in essentially the same methodology for, and end product of, plastic design as included in the AISC ASD Specification (AISC, 1989) except that the LRFD provisions tend to be slightly more liberal, reflecting added experience and the results of further research. The 10 percent redistribution permitted is consistent with that in the AISC ASD Specification (AISC, 1989).

In some circumstances, as in the proportioning of the bracing members that carry no calculated forces (see Section C3) and of connection components (see Section J1.7), the required strength is explicitly stated in the Specification.

### 2. Limit States

A limit state is a condition which represents the limit of structural usefulness. Limit states may be dictated by functional requirements, such as maximum deflections or drift; they may be conceptual, such as plastic hinge or mechanism formation; or they may represent the actual collapse of the whole or part of the structure, such as fracture or instability. Design criteria ensure that a limit state is violated only with an acceptably small probability by selecting the combination of load and resistance factors and nominal load and resistance values which will never be exceeded under the design assumptions.

Two kinds of limit states apply for structures: limit states of strength which define safety against extreme loads during the intended life of the structure, and limit states of serviceability which define functional requirements. The LRFD Specification, like other structural codes, focuses on the limit states of strength because of overriding considerations of public safety for the life, limb, and property of human beings. This does not mean that limit states of serviceability are not important to the designer, who must equally ensure functional performance and economy of design. However, these latter considerations permit more exercise of judgment on the part of designers. Minimum considerations of public safety, on the other hand, are not matters of individual judgment and, therefore, specifications dwell more on the limit states of strength than on the limit states of serviceability.

Limit states of strength vary from member to member, and several limit states may apply to a given member. The following limit states of strength are the most common: onset of yielding, formation of a plastic hinge, formation of a plastic mechanism, overall frame or member instability, lateral-torsional buckling, local buckling, tensile fracture, development of fatigue cracks, deflection instability, alternating plasticity, and excessive deformation. The most common serviceability limit states include unacceptable elastic deflections and drift, unacceptable vibrations, and permanent deformations.

### 3. Design for Strength

The general format of the LRFD Specification is given by the formula:

$$\sum \gamma_i Q_i \leq \phi R_n \quad (\text{C-A5-1})$$

where

- $\Sigma$  = summation
- $i$  = type of load, i.e., dead load, live load, wind, etc.
- $Q_i$  = nominal load effect
- $\gamma_i$  = load factor corresponding to  $Q_i$
- $\Sigma\gamma_i Q_i$  = required strength
- $R_n$  = nominal strength
- $\phi$  = resistance factor corresponding to  $R_n$
- $\phi R_n$  = design strength

The left side of Equation C-A5-1 represents the required resistance computed by structural analysis based upon assumed loads, and the right side of Equation C-A5-1 represents a limiting structural capacity provided by the selected members. In LRFD, the designer compares the effect of factored loads to the strength actually provided. The term design strength refers to the resistance or strength  $\phi R_n$  that must be provided by the selected member. The load factors  $\gamma$  and the resistance factors  $\phi$  reflect the fact that loads, load effects (the computed forces and moments in the structural elements), and the resistances can be determined only to imperfect degrees of accuracy. The resistance factor  $\phi$  is equal to or less than 1.0 because there is always a chance for the actual resistance to be less than the nominal value  $R_n$  computed by the equations given in Chapters D through K. Similarly, the load factors  $\gamma$  reflect the fact that the actual load effects may deviate from the nominal values of  $Q_i$  computed from the specified nominal loads. These factors account for unavoidable inaccuracies in the theory, variations in the material properties and dimensions, and uncertainties in the determination of loads. They provide a margin of reliability to account for unexpected loads. They do not account for gross error or negligence.

The LRFD Specification is based on (1) probabilistic models of loads and resistance, (2) a calibration of the LRFD criteria to the 1978 edition of the AISC ASD Specification for selected members, and (3) the evaluation of the resulting criteria by judgment and past experience aided by comparative design office studies of representative structures.

The following is a brief summary of the probabilistic basis for LRFD (Ravindra and Galambos, 1978, and Ellingwood, MacGregor, Galambos, and Cornell, 1982). The load effects  $Q$  and the resistance factors  $R$  are assumed to be statistically independent random variables. In Figure C-A5.1, frequency distributions for  $Q$  and  $R$  are portrayed as separate curves on a common plot for a hypothetical case. As long as the resistance  $R$  is greater than (to the right of) the effects of the loads  $Q$ , a margin of safety for the particular limit state exists. However, because  $Q$  and  $R$  are random variables, there is some small probability that  $R$  may be less than  $Q$ , ( $R < Q$ ). The probability of this limit state is related to the degree of overlap of the frequency distributions in Figure C-A5.1, which depends on their relative positioning ( $R_m$  vs.  $Q_m$ ) and their dispersions.

An equivalent situation may be represented as in Figure C-A5.2. If the expression  $R < Q$  is divided by  $Q$  and the result expressed logarithmically, the result will be a single frequency distribution curve combining the uncertainties of both  $R$  and  $Q$ . The probability of attaining a limit state ( $R < Q$ ) is equal to the probability that  $\ln(R/Q) < 0$  and is represented by the shaded area in the diagram.

The shaded area may be reduced and thus reliability increased in either of two ways: (1) by moving the mean of  $\ln(R/Q)$  to the right, or (2) by reducing the spread of the curve for a given position of the mean relative to the origin. A convenient way of combining these two approaches is by defining the position of the mean using the standard deviation of  $\ln(R/Q)$  as the unit of measure. Thus, the distance from the origin to the mean is measured as the number of standard deviations of the function  $\ln(R/Q)$ . As shown in Figure C-A5.2, this is stated as  $\beta$  times  $\sigma_{\ln(R/Q)}$ , the standard deviation of  $\ln(R/Q)$ . The factor  $\beta$  therefore is called the “reliability index.”

If the actual shape of the distribution of  $\ln(R/Q)$  were known, and if an acceptable value of the probability of reaching the limit state could be agreed upon, one could establish a completely probability-based set of design criteria. Unfortunately, this much information frequently is not known. The distribution shape of each of the many variables (material, loads, etc.) has an influence on the shape of the distribution of  $\ln(R/Q)$ . Often only the means and the standard deviations of the many variables involved in the makeup of the resistance and the load effect can be estimated. However, this information is enough to build an approximate design criterion which is independent of the knowledge of the distribution, by stipulating the following design condition:

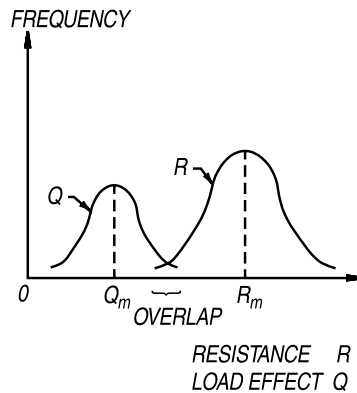

Fig. C-A5.1. Frequency distribution of load effect  $Q$  and resistance  $R$ .

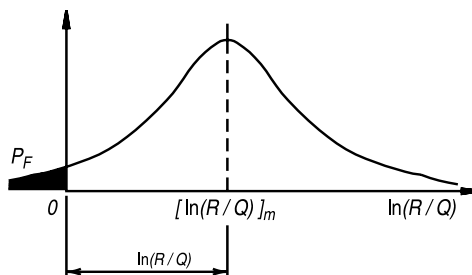

Fig. C-A5.2. Definition of Reliability Index.

$$\beta \sigma_{\ln(R/Q)} \approx \beta \sqrt{V_R^2 + V_Q^2} \leq \ln(R_m / Q_m) \quad (\text{C-A5-2})$$

In this equation, the standard deviation has been replaced by the approximation  $\sqrt{V_R^2 + V_Q^2}$ , where  $V_R = \sigma_R / R_m$  and  $V_Q = \sigma_Q / Q_m$  ( $\sigma_R$  and  $\sigma_Q$  are the standard deviations,  $R_m$  and  $Q_m$  are the mean values,  $V_R$  and  $V_Q$  are the coefficients of variation, respectively, of the resistance  $R$  and the load effect  $Q$ ). For structural elements and the usual loading,  $R_m$ ,  $Q_m$ , and the coefficients of variation,  $V_R$  and  $V_Q$ , can be estimated, so a calculation of

$$\beta = \frac{\ln(R_m / Q_m)}{\sqrt{V_R^2 + V_Q^2}} \quad (\text{C-A5-3})$$

will give a comparative value of the measure of reliability of a structure or component.

The description of the determination of  $\beta$  as given above is a simple way of defining the probabilistic method used in the development of LRFD. A more refined method, which can accommodate more complex design situations (such as the beam-column interaction equation) and include probabilistic distributions other than the lognormal distribution used to derive Equation C-A5-3, has been developed since the publication of Ravindra and Galambos (1978), and is fully described in Galambos, Ellingwood, MacGregor, and Cornell (1982). This latter method has been used in the development of the recommended load combinations in ASCE 7. The two methods give essentially the same  $\beta$  values for most steel structural members and connections.

Statistical properties (mean values and coefficients of variations) are presented for the basic material properties and for steel beams, columns, composite beams, plate girders, beam-columns, and connection elements in a series of eight articles in the September 1978 issue of the *Journal of the Structural Division of ASCE* (Vol. 104, ST9). The corresponding load statistics are given in Galambos, et al. (1982). Based on these statistics, the values of  $\beta$  inherent in the 1978 edition of the AISC ASD Specification were evaluated under different load combinations (live/dead, wind/dead, etc.), and for various tributary areas for typical members (beams, columns, beam-columns, structural components, etc.). As might be expected, there was a considerable variation in the range of  $\beta$  values. Examination of the many  $\beta$  values associated with ASD revealed certain trends. For example, compact rolled beams (flexure) and tension members (yielding) had  $\beta$  values that decreased from about 3.1 at  $L/D = 0.50$  to 2.4 at  $L/D = 4$ . This decrease is a result of ASD applying the same factor to dead load, which is relatively predictable, and live load, which is more variable. For bolted or welded connections,  $\beta$  was on the order of 4 to 5. Reliability indices for load combinations involving wind and earthquake loads tended to be lower. Based on a thorough assessment of implied reliabilities in existing acceptable design practice, common load factors for various structural materials (steel, reinforced concrete, etc.) were developed in Ellingwood et al. (1982).

One of the features of the probability-based method used in the development of LRFD is that the variations of  $\beta$  values can be reduced by specifying several "target"  $\beta$  values and selecting multiple load and resistance factors to meet these targets. The Committee on Specifications set the point at which LRFD is calibrated



to ASD at  $L/D = 3.0$  for braced compact beams in flexure and tension members at yield. The resistance factor,  $\phi$ , for these limit states is 0.90, and the implied  $\beta$  is approximately 2.6 for members and 4.0 for connections; this larger  $\beta$  value for connections reflects the fact that connections are expected to be stronger than the members that they connect. Limit states for other members are handled consistently.

Computer methods as well as charts are given in Ellingwood et al. (1982) for the use of specification writers to determine the resistance factors  $\phi$ . These factors can also be approximately determined by the following:

$$\phi = (R_m / R_n) \exp(-0.55\beta V_r) \quad (\text{C-A5-4})^*$$

where

$R_m$  = mean resistance

$R_n$  = nominal resistance according to the equations in Chapters D through K

$V_r$  = coefficient of variation of the resistance

#### 4. Design for Serviceability and Other Considerations

Nominally, serviceability should be checked at the unfactored loads. For combinations of gravity and wind or seismic loads some additional reduction factor may be warranted.

---

\*Note that  $\exp(x)$  is identical to the more familiar  $e^x$

## CHAPTER B

### DESIGN REQUIREMENTS

#### B2. NET AREA

Critical net area is based on net width and load transfer at a particular chain.

#### B3. EFFECTIVE AREA OF TENSION MEMBERS

Section B3 deals with the effect of shear lag, which is applicable to both welded and bolted tension members. The reduction coefficient  $U$  is applied to the net area  $A_n$  of bolted members and to the gross area  $A_g$  of welded members. As the length of connection  $l$  is increased, the shear lag effect is diminished. This concept is expressed empirically by the equation for  $U$ . Munse and Chesson (1963) have shown that using this expression to compute an effective area, with few exceptions, the estimated strength of some 1,000 bolted and riveted connection test specimens correlated with observed test results within a scatterband of  $\pm 10$  percent. Newer research (Easterling and Gonzales, 1993) provides further justification for current provisions.

For any given profile and connected elements,  $\bar{x}$  is a fixed geometric property. It is illustrated as the distance from the connection plane, or face of the member, to the centroid of the member section resisting the connection force. See Figure C-B3.1. The length  $l$  is dependent upon the number of fasteners or equivalent length of weld required to develop the given tensile force, and this in turn is dependent upon the mechanical properties of the member and the capacity of the fasteners or weld used. The length  $l$  is illustrated as the distance, parallel to the line of force, between the first and last fasteners in a line for bolted connections. The number of bolts in a line, for the purpose of the determination of  $l$ , is determined by the line with the maximum number of bolts in the connection. For staggered bolts, the out-to-out dimension is used for  $l$ . See Figure C-B3.2. There is insufficient data to establish a value of  $U$  if all lines have only one bolt, but it is probably conservative to use  $A_e$  equal to the net area of the connected element. For welded connections,  $l$  is the length of the weld parallel to the line of force. For combinations of longitudinal and transverse welds (see Figure C-B3.3),  $l$  is the length of longitudinal weld because the transverse weld has little or no effect on the shear lag problem, i.e., it does little to get the load into the unattached portions of the member.

Previous issues of this Specification have presented values for  $U$  for bolted or riveted connections of W, M, and S shapes, tees cut from these shapes, and other shapes. These values are acceptable for use in lieu of calculated values and are retained here for the convenience of designers.

For bolted or riveted connections the following values of  $U$  may be used:

- (a) W, M, or S shapes with flange widths not less than two-thirds the depth, and

structural tees cut from these shapes, provided the connection is to the flanges and has no fewer than three fasteners per line in the direction of stress,  $U = 0.90$ .

- (b) W, M, or S shapes not meeting the conditions of subparagraph a, structural tees cut from these shapes, and all other shapes including built-up cross sections, provided the connection is to the flanges and has no fewer than three fasteners per line in the direction of stress,  $U = 0.85$ .

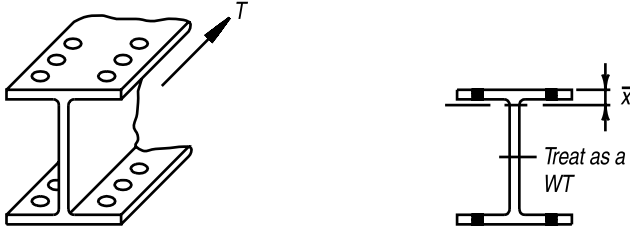

(a)

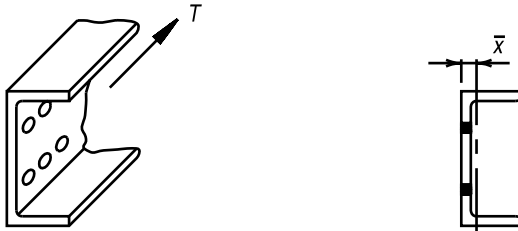

(b)

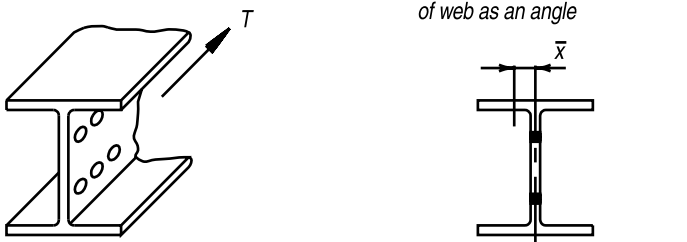

(c)

Fig. C-B3.1. Determination of  $\bar{x}$  for  $U$ .

- (c) All members having only two fasteners per line in the direction of stress,  $U = 0.75$ .

When a tension load is transmitted by fillet welds to some but not all elements of a cross section, the weld strength will control.

## B5. LOCAL BUCKLING

For the purposes of this Specification, steel sections are divided into compact sections, noncompact sections, and sections with slender compression elements. Compact sections are capable of developing a *fully plastic* stress distribution and they possess a rotational capacity of approximately 3 before the onset of local buckling (Yura, Galambos, and Ravindra, 1978). Noncompact sections can develop the yield stress in compression elements before local buckling occurs, but will not resist inelastic local buckling at the strain levels required for a fully plastic stress distribution. Slender compression elements buckle elastically before the yield stress is achieved.

The dividing line between compact and noncompact sections is the limiting width-thickness ratio  $\lambda_p$ . For a section to be compact, all of its compression elements must have width-thickness ratios equal to or smaller than the limiting  $\lambda_p$ .

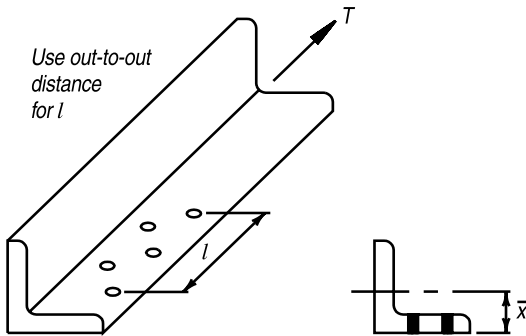

Fig. C-B3.2. Staggered holes.

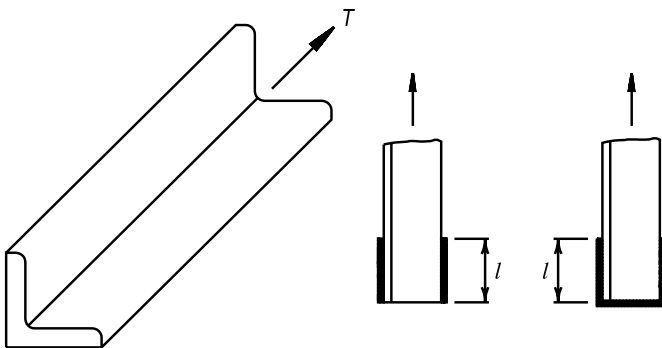

Fig. C-B3.3. Longitudinal and transverse welds.

**TABLE C-B5.1**  
**Limiting Width-Thickness Ratios for Compression Elements**

Description of Element	Width-Thickness Ratio	Limiting Width-thickness Ratios $\lambda_p$	
		Non-seismic	Seismic
Flanges of I-shaped sections (including hybrid sections) and channels in flexure [a]	$b / t$	$0.38\sqrt{E/F_y}$	$0.31\sqrt{E/F_y}$
Webs in combined flexural and axial compression	$h / t_w$	For $P_u / \phi_b P_y \leq 0.125$	
		$3.76\sqrt{\frac{E}{F_y}} \left( 1 - \frac{2.75P_u}{\phi_b P_y} \right)$	$3.05\sqrt{\frac{E}{F_y}} \left( 1 - \frac{1.54P_u}{\phi_b P_y} \right)$
		For $P_u / \phi_b P_y > 0.125$	
		$1.12\sqrt{\frac{E}{F_y}} \left( 2.33 - \frac{P_u}{\phi_b P_y} \right) \geq 1.49\sqrt{\frac{E}{F_y}}$	
[a] For hybrid beams use $F_{yf}$ in place of $F_y$			

A greater inelastic rotation capacity than provided by the limiting values  $\lambda_p$  given in Table C-B5.1 may be required for some structures in areas of high seismicity. It has been suggested that in order to develop a ductility of from 3 to 5 in a structural member, ductility factors for elements would have to lie in the range of 5 to 15. Thus, in this case it is prudent to provide for an inelastic rotation of 7 to 9 times the elastic rotation (Chopra and Newmark, 1980). In order to provide for this rotation capacity, the limits  $\lambda_p$  for local flange and web buckling would be as shown in Table C-B5.1 (Galambos, 1976).

More information on seismic design is contained in the AISC *Seismic Provisions for Structural Steel Buildings* (AISC, 1997) and the *Seismic Provisions for Structural Steel Buildings Supplement No. 1* (AISC, 1999).

Another limiting width-thickness ratio is  $\lambda_r$ , representing the distinction between noncompact sections and sections with slender compression elements. As long as the width-thickness ratio of a compression element does not exceed the limiting value  $\lambda_r$ , local elastic buckling will not govern its strength. However, for those cases where the width-thickness ratios exceed  $\lambda_r$ , elastic buckling strength must be considered. A design procedure for such slender-element compression sections, based on elastic buckling of plates, is given in Appendix B5.3. The effective width Equation A-B5-12 applies strictly to stiffened elements under uniform compression. It does not apply to cases where the compression element is under stress gradient. A method of dealing with the stress gradient in a compression element is provided in Section B2 of the AISI *Specification for the Design of Cold-Formed Steel Structural Members* (1996). Exceptions are girders with slender webs. Such plate girders are capable of developing postbuckling strength in excess of the elastic buckling

load. A design procedure for plate girders including tension field action is given in Appendix G.

The values of the limiting ratios  $\lambda_p$  and  $\lambda_r$  specified in Table B5.1 are similar to those in AISC (1989) and Table 2.3.3.3 of Galambos (1976), except that: (1)  $\lambda_p = 0.38\sqrt{E/F_y}$ , limited in Galambos (1976) to indeterminate beams when moments are determined by elastic analysis and to determinate beams, was adopted for all conditions on the basis of Yura et al. (1978); and (2)  $\lambda_p = 0.045E/F_y$  for plastic design of circular hollow sections was obtained from Sherman (1976).

The high shape factor for circular hollow sections makes it impractical to use the same slenderness limits to define the regions of behavior for different types of loading. In Table B5.1, the values of  $\lambda_p$  for a compact shape that can achieve the plastic moment, and  $\lambda_r$  for bending, are based on an analysis of test data from several projects involving the bending of pipes in a region of constant moment (Sherman and Tanavde, 1984, and Galambos, 1998). The same analysis produced the equation for the inelastic moment capacity in Table A-F1.1 in Appendix F1. However, a more restrictive value of  $\lambda_p$  is required to prevent inelastic local buckling from limiting the plastic hinge rotation capacity needed to develop a mechanism in a circular hollow beam section (Sherman, 1976).

The values of  $\lambda_r$  for axial compression and for bending are both based on test data. The former value has been used in building specifications since 1968 (Winter, 1970). Appendices B5 and F1 also limit the diameter-to-thickness ratio for any circular section to  $0.45E/F_y$ . Beyond this, the local buckling strength decreases rapidly, making it impractical to use these sections in building construction.

Following the SSRC recommendations (Galambos, 1998) and the approach used for other shapes with slender compression elements, a  $Q$  factor is used for circular sections to account for interaction between local and column buckling. The  $Q$  factor is the ratio between the local buckling stress and the yield stress. The local buckling stress for the circular section is taken from the inelastic AISI criteria (Winter, 1970) and is based on tests conducted on fabricated and manufactured cylinders. Subsequent tests on fabricated cylinders (Galambos, 1998) confirm that this equation is conservative.

The definitions of the width and thickness of compression elements agree with the 1978 AISC ASD Specification with minor modifications. Their applicability extends to sections formed by bending and to unsymmetrical and hybrid sections.

For built-up I-shaped sections under axial compression, modifications have been made to the flange local buckling criterion to include web-flange interaction. The  $k_c$  in the  $\lambda_r$  limit, in Equations A-B5-7 and A-B5-8 and the elastic buckling Equation A-B5-8 are the same that are used for flexural members. Theory indicates that the web-flange interaction in axial compression is at least as severe as in flexure. Rolled shapes are excluded from this criterion because there are no standard sections with proportions where the interaction would occur. In built-up sections where the interaction causes a reduction in the flange local buckling strength, it is likely that the web is also a thin stiffened element.

The  $k_c$  factor accounts for the interaction of flange and web local buckling demonstrated in experiments conducted by Johnson (1985). The maximum limit of 0.763 corresponds to  $F_{cr} = 0.69E / \lambda^2$  which was used as the local buckling strength in

earlier editions of both the ASD and LRFD Specifications. An  $h/t_w = 27.5$  is required to reach  $k_c = 0.763$ . Fully fixed restraint for an unstiffened compression element corresponds to  $k_c = 1.3$  while zero restraint gives  $k_c = 0.42$ . Because of web-flange interactions it is possible to get  $k_c < 0.42$  from the new  $k_c$  formula. If  $h/t_w > 5.70\sqrt{E/F_y}$  use  $h/t_w = 5.70\sqrt{E/F_y}$  in the  $k_c$  equation, which corresponds to the 0.35 limit.

Illustrations of some of the requirements of Table B5.1 are shown in Figure C-B5.1.

## **B7. LIMITING SLENDERNESS RATIOS**

Chapters D and E provide reliable criteria for resistance of axially loaded members based on theory and confirmed by tests for all significant parameters including slenderness. The advisory upper limits on slenderness contained in Section B7 are based on professional judgment and practical considerations of economics, ease of handling, and care required to minimize inadvertent damage during fabrication, transport, and erection. Out-of-straightness within reasonable tolerances does not affect the strength of tension members, and the effect of out-of-straightness within specified tolerances on the strength of compression members is accounted for in formulas for resistance. Applied tension tends to reduce, whereas compression tends to amplify, out-of-straightness. Therefore, more liberal criteria are suggested for tension members, including those subject to small compressive forces resulting from transient loads such as earthquake and wind. For members with slenderness ratios greater than 200, these compressive forces correspond to  $\phi_c F_{cr}$  less than 5.33 ksi (18 MPa).

	BENDING		AXIAL COMPRESSION
	$\lambda_p = 0.38 \sqrt{\frac{E}{F_y}}$	$\lambda_r = 0.83 \sqrt{\frac{E}{F_L}}$	$\lambda_r = 0.56 \sqrt{\frac{E}{F_y}}$
	$\lambda_p = 3.75 \sqrt{\frac{E}{F_y}}$	$\lambda_r = 5.70 \sqrt{\frac{E}{F_y}}$	$\lambda_r = 1.49 \sqrt{\frac{E}{F_y}}$
	(perforated $\lambda_p = 1.12 \sqrt{\frac{E}{F_y}}$ )	$\lambda_r = 1.86 \sqrt{\frac{E}{F_y}}$	$\lambda_r = 1.86 \sqrt{\frac{E}{F_y}}$
	$\lambda_p = 0.38 \sqrt{\frac{E}{F_y}}$	$\lambda_r = 1.40 \sqrt{\frac{E}{F_y}}$	$\lambda_r = 1.40 \sqrt{\frac{E}{F_y}}$
	$\lambda_p = 0.38 \sqrt{\frac{E}{F_y}}$	$\lambda_r = 0.95 \sqrt{\frac{E}{F_L / k_c}}$	$\lambda_r = 0.64 \sqrt{\frac{E}{F_y / k_c}}$
		$\lambda_r = 0.56 \sqrt{\frac{E}{F_y}}$	$\lambda_r = 0.64 \sqrt{\frac{E}{F_y / k_c}}$
	$\lambda_p = 3.76 \sqrt{\frac{E}{F_y}}$	$\lambda_r = 5.70 \sqrt{\frac{E}{F_y}}$	$\lambda_r = 1.49 \sqrt{\frac{E}{F_y}}$
	$\lambda_p = 1.12 \sqrt{\frac{E}{F_y}}$	$\lambda_r = 1.40 \sqrt{\frac{E}{F_y}}$	$\lambda_r = 1.40 \sqrt{\frac{E}{F_y}}$
	$\lambda_p = 3.76 \sqrt{\frac{E}{F_y}}$	$\lambda_r = 5.70 \sqrt{\frac{E}{F_y}}$	$\lambda_r = 1.40 \sqrt{\frac{E}{F_y}}$
		$\lambda_r = 1.49 \sqrt{\frac{E}{F_y}}$	$\lambda_r = 1.49 \sqrt{\frac{E}{F_y}}$
		$\lambda_r = 5.70 \sqrt{\frac{E}{F_y}}$	$\lambda_r = 1.49 \sqrt{\frac{E}{F_y}}$

Fig. C-B5.1 Selected examples of Table B5.1 requirements.



## CHAPTER C

### FRAMES AND OTHER STRUCTURES

#### C1. SECOND ORDER EFFECTS

While resistance to wind and seismic loading can be provided in certain buildings by means of shear walls, which also provide for overall frame stability at factored gravity loading, other building frames must provide this resistance by frame action. This resistance can be achieved in several ways, e.g., by a system of bracing, by a moment-resisting frame, or by any combination of lateral force-resisting elements.

For frames under combined gravity and lateral loads, drift (horizontal deflection caused by applied loads) occurs at the start of loading. At a given value of the applied loads, the frame has a definite amount of drift  $\Delta$ . In unbraced frames, additional secondary bending moments, known as the  $P\Delta$  moments, may be developed in the columns and beams of the lateral load-resisting systems in each story.  $P$  is the total gravity load above the story and  $\Delta$  is the story drift. As the applied load increases, the  $P\Delta$  moments also increase. Therefore, the  $P\Delta$  effect must often be accounted for in frame design. Similarly, in braced frames, increases in axial forces occur in the members of the bracing systems; however, such effects are usually less significant. The designer should consider these effects for all types of frames and determine if they are significant. Since  $P\Delta$  effects can cause frame drifts to be larger than those calculated by ignoring them, they should also be included in the service load drift analysis when they are significant.

In unbraced frames designed by plastic analysis, the limit of  $0.75\phi_c P_y$  on column axial loads has been retained to help ensure stability.

The designer may use second-order elastic analysis to compute the maximum factored forces and moments in a member. These represent the required strength. Alternatively, for structures designed on the basis of elastic analysis, the designer may use first order analysis and the amplification factors  $B_1$  and  $B_2$ .

In the general case, a member may have first order moments not associated with sidesway which are multiplied by  $B_1$ , and first order moments produced by forces causing sidesway which are multiplied by  $B_2$ .

The factor  $B_2$  applies only to moments caused by forces producing sidesway and is calculated for an entire story. In building frames designed to limit  $\Delta_{oh}/L$  to a predetermined value, the factor  $B_2$  may be found in advance of designing individual members.

Drift limits may also be set for design of various categories of buildings so that the effect of secondary bending can be insignificant (Kanchanalai and Lu, 1979, and ATC, 1978). It is conservative to use the  $B_2$  factor with the sum of the sway and the no-sway moments, i.e., with  $M_{lt} + M_{nt}$ .

The two kinds of first order moment  $M_{nt}$  and  $M_{lt}$  may both occur in sidesway frames from gravity loads.  $M_{nt}$  is defined as a moment developed in a member with frame sidesway prevented. If a significant restraining force is necessary to prevent sidesway of an unsymmetrical structure (or an unsymmetrically loaded symmetrical structure), the moments induced by releasing the restraining force will be  $M_{lt}$  moments, to be multiplied by  $B_2$ . In most reasonably symmetric frames, this effect will be small. If such a moment  $B_2 M_{lt}$  is added algebraically to the  $B_1 M_{nt}$  moment developed with sidesway prevented, a fairly accurate value of  $M_{lt}$  will result. End moments produced in sidesway frames by lateral loads from wind or earthquake will always be  $M_{lt}$  moments to be multiplied by  $B_2$ .

When first order end moments in members subjected to axial compression are magnified by  $B_1$  and  $B_2$  factors, equilibrium requires that they be balanced by moments in connected members (Figure C-C1.1). This can generally be accomplished satisfactorily by distributing the difference between the magnified moment and the first order moment to any other moment-resisting members attached to the compressed member (or members) in proportion to the relative stiffness of the uncompressed members. Minor imbalances may be neglected in the judgment of the engineer. However, complex conditions, such as occur when there is significant magnification in several members meeting at a joint, may require a second order elastic analysis. Connections shall also be designed to resist the magnified end moments.

The center-to-center member length is usually used in the structural analysis. In braced and unbraced frames,  $P_n$  is governed by the maximum slenderness ratio regardless of the plane of bending. However,  $P_{e1}$  and  $P_{e2}$  are always calculated using the slenderness ratio in the plane of bending. Thus, when flexure is about the strong

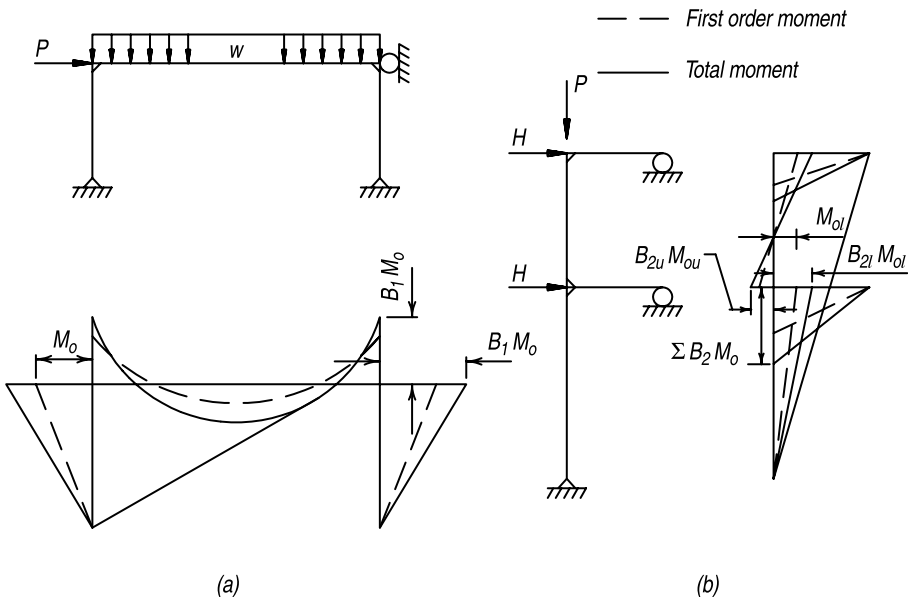

Fig. C-C1.1. Moment amplification.

axis only, two different values of slenderness ratio may be involved in solving a given problem.

When second order analysis is used, it must account for the interaction of the factored load effects, that is, combinations of factored loads must be used in analysis. Superposition of forces obtained from separate analyses is not adequate.

When bending occurs about both the x and the y axes, the required flexural strength calculated about each axis is adjusted by the value of  $C_m$  and  $P_{e1}$  or  $P_{e2}$  corresponding to the distribution of moment and the slenderness ratio in its plane of bending, and is then taken as a fraction of the design bending strength,  $\phi_b M_n$ , about that axis, with due regard to the unbraced length of the compression flange where this is a factor.

Equations C1-2 and C1-3 approximate the maximum second order moments in compression members with no relative joint translation and no transverse loads between the ends of the member. This approximation is compared to an exact solution (Ketter, 1961) in Figure C-C1.2. For single curvature, Equation C1-3 is slightly unconservative, for a zero end moment it is almost exact, and for double curvature it is conservative. The 1978 AISC ASD Specification imposed the limit  $C_m \geq 0.4$  which corresponds to a  $M_1 / M_2$  ratio of 0.5. However, Figure C-C1.2 shows that if, for example,  $M_1 / M_2 = 0.8$ , the  $C_m = 0.28$  is already very conservative, so the limit has been removed. The limit was originally adopted from Austin (1961), which was intended to apply to lateral-torsional buckling, not second-order in-plane bending strength. The AISC Specifications, both in the 1989 ASD and LRFD, use a modification factor  $C_b$  as given in Equation F1-3 for lateral-torsional buckling.  $C_b$  is approximately the inverse of  $C_m$  as presented in Austin (1961) with a 0.4 limit. In

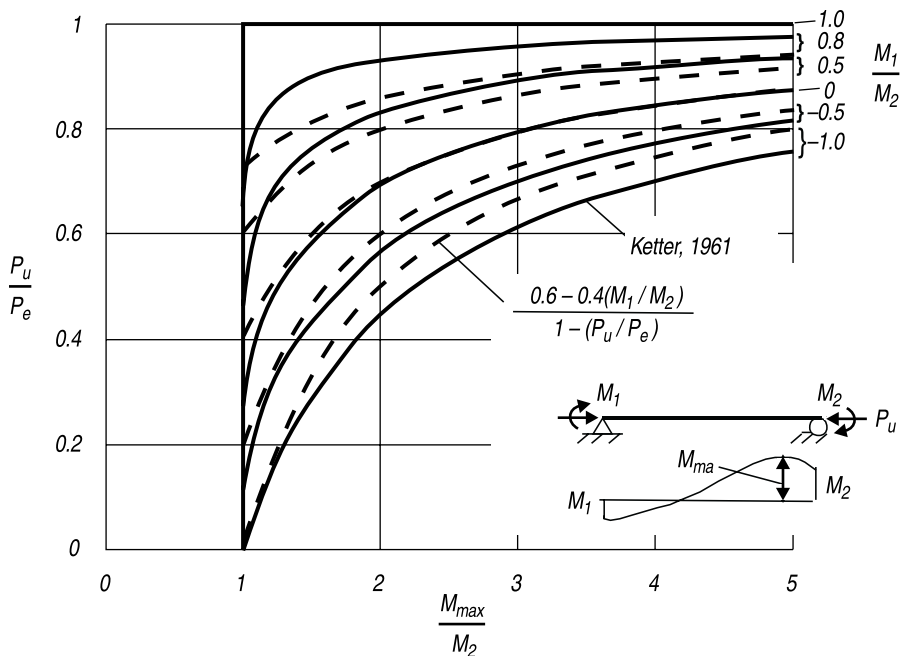
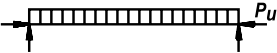

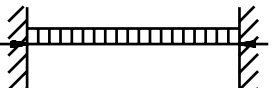
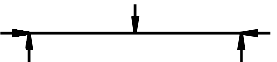
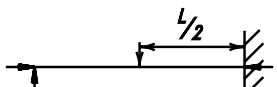
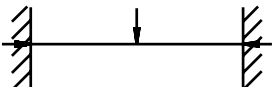

Fig. C-C1.2. Second-order moments for beam-columns in braced frames.

**TABLE C-C1.1**  
**Amplification Factors  $\psi$  and  $C_m$**

Case	$\psi$	$C_m$
	0	1.0
	-0.4	$1 - 0.4 \frac{P_u}{P_{e1}}$
	-0.4	$1 - 0.4 \frac{P_u}{P_{e1}}$
	-0.2	$1 - 0.2 \frac{P_u}{P_{e1}}$
	-0.3	$1 - 0.3 \frac{P_u}{P_{e1}}$
	-0.2	$1 - 0.2 \frac{P_u}{P_{e1}}$

Galambos (1961) it was pointed out that Equation C1-3 could be used for in-plane second order moments if the 0.4 limit was eliminated. Unfortunately, Austin (1961) was misinterpreted and a lateral-torsional buckling solution was used for an in-plane second-order analysis. This oversight has now been corrected.

For beam columns with transverse loadings, the second-order moment can be approximated by using the following equation

$$C_m = 1 + \psi P_u / P_{e1}$$

for simply supported members

where

$$\psi = \frac{\pi^2 \delta_o EI}{M_o L^2} - 1$$

$\delta_o$  = maximum deflection due to transverse loading, in. (mm)

$M_o$  = maximum factored design moment between supports due to transverse loading, kip-in. (N-mm)

For restrained ends, some limiting cases are given in Table C-C1.1 together with two cases of simply supported beam-columns (Iwankiw, 1984). These values of  $C_m$  are always used with the maximum moment in the member. For the restrained-end

cases, the values of  $B_1$  will be most accurate if values of  $K < 1.0$  corresponding to the end boundary conditions are used in calculating  $P_{e1}$ . In lieu of using the equations above,  $C_m = 1.0$  can be used conservatively for transversely loaded members with unrestrained ends and 0.85 for restrained ends.

If, as in the case of a derrick boom, a beam-column is subject to transverse (gravity) load and a calculable amount of end moment, the value  $\delta_0$  should include the deflection between supports produced by this moment.

Stiffness reduction adjustment due to column inelasticity is permitted.

## C2. FRAME STABILITY

The stability of structures must be considered from the standpoint of the structure as a whole, including not only the compression members, but also the beams, bracing system, and connections. The stability of individual elements must also be provided. Considerable attention has been given in the technical literature to this subject, and various methods of analysis are available to assure stability. The *Guide to Stability Design Criteria for Metal Structures* (Galambos, 1998) considers the stability of individual elements, and the effects of individual elements on the stability of the structure as a whole.

The effective length concept is one method of estimating the interaction effects of the total frame on a compression element being considered. This concept uses  $K$  factors to equate the strength of a framed compression element of length  $L$  to an equivalent pin-ended member of length  $KL$  subject to axial load only. Other rational methods are available for evaluating the stability of frames subject to gravity and side loading and individual compression members subject to axial load and moments. Although the concept is completely valid for ideal structures, its practical implementation involves several assumptions of idealized conditions which will be mentioned later.

Two conditions, opposite in their effect upon column strength under axial loading, must be considered. If enough axial load is applied to the columns in an unbraced frame dependent entirely on their own bending stiffness for resistance to lateral deflection of the tops of the columns with respect to their bases (see Figure C-C2.1), the effective length of these columns will exceed the actual length. On the other hand, if the same frame were braced to resist such lateral movement, the effective length would be less than the actual length, due to the restraint (resistance to joint translation) provided by the bracing or other lateral support. The ratio  $K$ , effective column length to actual unbraced length, may be greater or less than 1.0.

The theoretical  $K$  values for six idealized conditions in which joint rotation and translation are either fully realized or nonexistent are tabulated in Table C-C2.1.

Also shown are suggested design values recommended by the Structural Stability Research Council (SSRC) for use when these conditions are approximated in actual design. In general, these suggested values are slightly higher than their theoretical equivalents, since joint fixity is seldom fully realized.

If the column base in Case (f) of Table C-C2.1 were truly pinned,  $K$  would actually exceed 2.0 for a frame such as that pictured in Figure C-C2.1, because the flexibility of the horizontal member would prevent realization of full fixity at the top of the column. On the other hand, it has been shown (Galambos, 1960) that the restraining

**Table C-C2.1**  
**K Values for Columns**

Buckled shape of column is shown by dashed line.	(a)	(b)	(c)	(d)	(e)	(f)
Theoretical $K$ value	0.5	0.7	1.0	1.0	2.0	2.0
Recommended design value when ideal conditions are approximated	0.65	0.80	1.2	1.0	2.10	2.0
End condition code	<div style="display: flex; flex-direction: column; align-items: center;"> <div style="display: flex; align-items: center; margin-bottom: 5px;"> <span>Rotation fixed and translation fixed</span> </div> <div style="display: flex; align-items: center; margin-bottom: 5px;"> <span>Rotation free and translation fixed</span> </div> <div style="display: flex; align-items: center; margin-bottom: 5px;"> <span>Rotation fixed and translation free</span> </div> <div style="display: flex; align-items: center;"> <span>Rotation free and translation free</span> </div> </div>					

influence of foundations, even where these footings are designed only for vertical load, can be very substantial in the case of flat-ended column base details with ordinary anchorage. For this condition, a design  $K$  value of 1.5 would generally be conservative in Case (f).

While in some cases masonry walls provide enough lateral support for building frames to control lateral deflection, light curtain wall construction and wide column spacing can create a situation where only the bending stiffness of the frame provides this support. In this case the effective length factor  $K$  for an unbraced length of column  $L$  is dependent upon the bending stiffness provided by the other in-plane members entering the joint at each end of the unbraced segment. If the combined stiffness provided by the beams is sufficiently small, relative to that of the unbraced column segments,  $KL$  could exceed two or more story heights (Bleich, 1952).

Translation of the joints in the plane of a truss is inhibited and, due to end restraint, the effective length of compression members might be assumed to be less than the distance between panel points. However, it is usual practice to take  $K$  as equal to 1.0 (ASCE Task Committee on Effective Length, 1997). If all members of the truss reached their ultimate load capacity simultaneously, the restraints at the ends of the compression members would be greatly reduced.

Several rational methods are available to estimate the effective length of the columns in an unbraced frame with sufficient accuracy for design. These range from simple interpolation between the idealized cases shown in Table C-C2.1 to compre-

hensive analytical procedures. Once a trial selection of framing members has been made, the use of the alignment chart in Figures C-C2.2a and b affords a fairly rapid method for determining adequate  $K$  values. However, it should be noted that this alignment chart is based upon assumptions of idealized conditions which seldom exist in real structures (ASCE Task Committee on Effective Length, 1997). These assumptions are as follows:

- (1) Behavior is purely elastic.
- (2) All members have constant cross section.
- (3) All joints are rigid.
- (4) For braced frames, rotations at opposite ends of beams are equal in magnitude, producing single-curvature bending.
- (5) For unbraced frames, rotations at opposite ends of the restraining beams are equal in magnitude, producing reverse-curvature bending (inflection point at the beam midspan from lateral loading only).
- (6) The stiffness parameter  $L\sqrt{P/EI}$  of all columns are equal.
- (7) Joint restraint is distributed to the column above and below the joint in proportion to  $I/L$  of the two columns.
- (8) All columns buckle simultaneously.
- (9) No significant axial compression force exists in the girders.

The alignment chart for sidesway uninhibited shown in Figure C-C2.2b is based on the following equation:

$$\frac{G_A G_B (\pi/K)^2 - 36}{6(G_A + G_B)} - \frac{(\pi/K)}{\tan(\pi/K)} = 0 \quad (\text{C-C2-1})$$

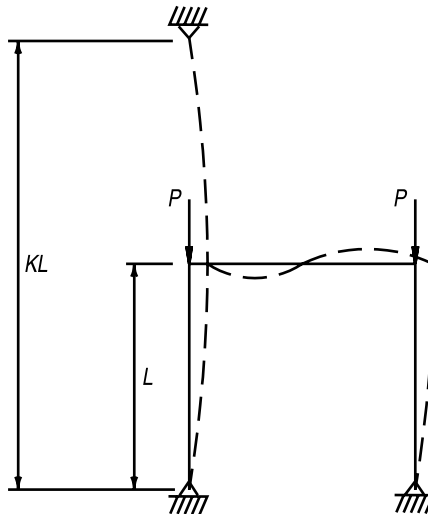
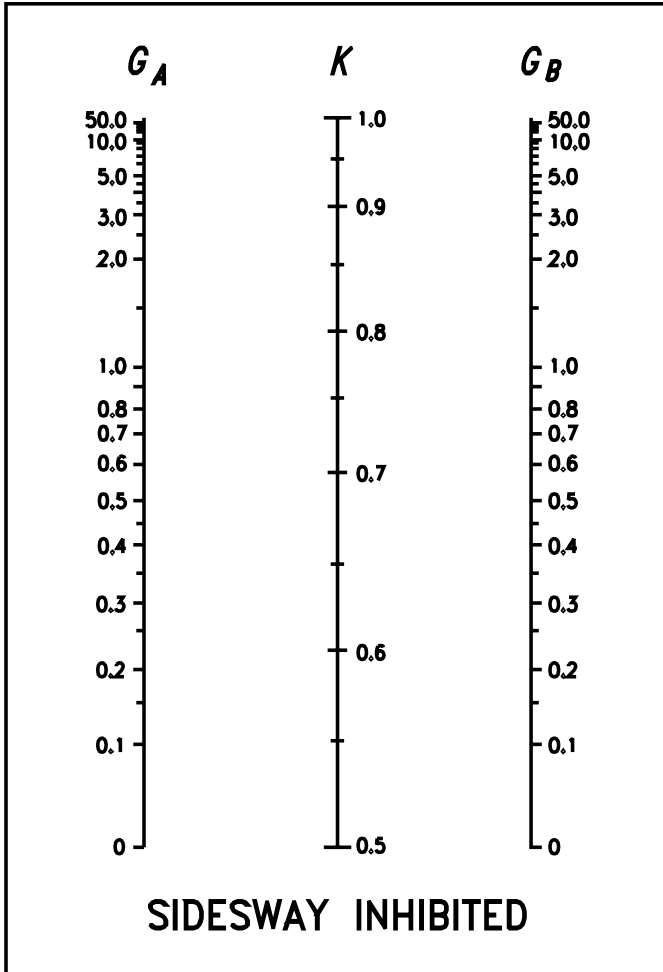

Fig. C-C2.1. Column effective length.



Notes for Fig. C-C2.2a and b: The subscripts A and B refer to the joints at the two ends of the column section being considered.  $G$  is defined as

$$G = \frac{\Sigma(I_c / L_c)}{\Sigma(I_g / L_g)}$$

in which  $\Sigma$  indicates a summation of all members rigidly connected to that joint and lying on the plane in which buckling of the column is being considered.  $I_c$  is the moment of inertia and  $L_c$  the unsupported length of a column section, and  $I_g$  is the moment of inertia and  $L_g$  the unsupported length of a girder or other restraining member.  $I_c$  and  $I_g$  are taken about axes perpendicular to the plane of buckling being considered.

For column ends supported by but not rigidly connected to a footing or foundation,  $G$  is theoretically infinity, but, unless actually designed as a true friction-free pin, may be taken as "10" for practical designs. If the column end is rigidly attached to a properly designed footing,  $G$  may be

Fig. C-C2.2a. Alignment chart for effective length of columns in continuous frames – Sidesway Inhibited.



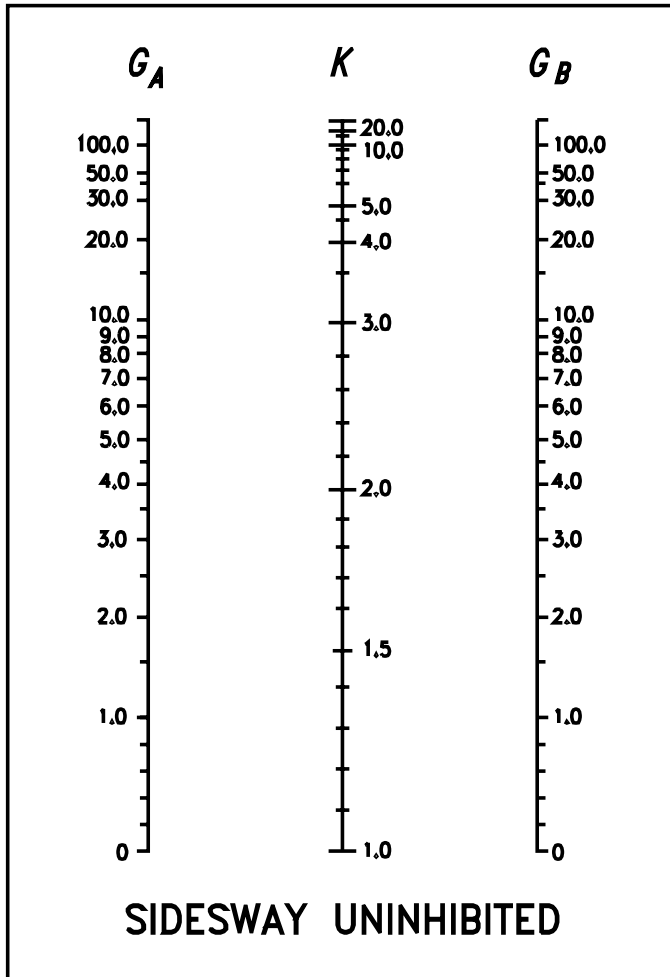

See Notes in Fig. C-C2.2a.

Fig. C-C2.2b. Alignment chart for effective length of columns in continuous frames – Sidesway Uninhibited.

with  $G$  defined as

$$G = \frac{\sum(EI / L)_c}{\sum(EI / L)_g} \tag{C-C2-2}$$

The expression for  $G$  given in the footnote of the alignment chart has assumed that  $E$  of the beams and columns are the same. However the alignment chart is valid for different materials if Equation C-C2-2 is used. An equation for the sidesway-inhibited chart can be found in ASCE Task Committee on Effective Length (1997).

Where the actual conditions differ from the assumptions above, unrealistic  $K$  factors may result. There are modifications available that may be used with Figure C-C2.2b or Equation C-C2-1 to give buckling loads that better reflect the conditions in real structures (ASCE Task Committee on Effective Length, 1997 and Chen and Lui, 1987). Some of the modifications are summarized below.

Columns loaded into the inelastic range of column behavior can be viewed as having a tangent modulus  $E_T$  that is smaller than  $E$ . For such columns,  $E_c/E_g = E_T/E$  in Equation C-C2-2, which gives smaller  $G$  values, and therefore, smaller  $K$  factors than those based on elastic behavior (assumption 1). It is conservative to base the column design on elastic  $K$  factors. For less conservative solutions, inelastic  $K$  factors can be determined by using  $\tau E$  for  $E_c$  in Equation C-C2-2 where  $\tau = E_T/E$  is a stiffness reduction factor (SRF). Yura (1971) and Disque (1973) showed that the SRF could be determined from the ratio of the inelastic column design strength to the elastic column design strength. Using the column design strengths  $\phi P_u$  from Equation E2-2 (inelastic) and E2-3 (elastic) gives

$$(a) \text{ For } (P_u / P_y) \leq \frac{1}{3} \text{ (elastic); } \tau = 1.0$$

$$(b) \text{ For } (P_u / P_y) > \frac{1}{3} \text{ (inelastic)}$$

$$\tau = -7.38(P_u / P_y) \log \left( \frac{(P_u / P_y)}{0.85} \right) \quad (C-C2-3)$$

where  $P_y$  is the column squash load,  $(F_y A_g)$ , and  $P_u$  is the required column strength.  $P_u$  must not exceed  $\phi_c P_y$ .

When a beam connection at the column under consideration is a shear connection (no moment), then that beam cannot be considered in the  $\sum(EI/L)_g$  term of Equation C-C2-2. Only FR connections can be used directly in the determination of  $G$  (assumption 3). PR connections with a documented moment-rotation response can be utilized, but the  $(EI/L)_g$  of each beam must be adjusted to account for the connection flexibility. ASCE Task Committee on Effective Length (1997) provides a detailed discussion of frame stability with PR connections. PR connections cannot be considered as rigid (FR) connections when assessing frame stability. Section A2 contains additional information on PR connections.

A beam stiffness of  $6EI/L$  was used in the development of Equation C-C2-1 (assumption 5). For other values of beam stiffness, use  $m(EI/L)_g$  in determining  $G$  where  $m = (\text{actual girder stiffness coefficient})/6$ . When the far end of a girder has a shear connection instead of a FR connection,  $m = 0.5$ . A general expression for  $m$  when the inflection point from a lateral load analysis is located anywhere along the girder span is available (ASCE Task Committee on Effective Length, 1997).

Compressive axial load in a girder reduces its stiffness, which will have an adverse effect on  $K$  of the column (see assumption 9). To account for any compressive axial load in a girder, the girder stiffness parameter  $(EI/L)_g$  in Equation C-C2-2 should be modified by the factor

$$\left[ 1 - \frac{Q}{Q_{cr}} \right] \quad (C-C2-4)$$

where  $Q$  is the axial load in the girder and  $Q_{cr}$  is the in plane buckling load of the girder based on  $K = 1.0$ . Tensile axial load in the girders can be ignored when determining  $G$ .

Sidesway instability of an unbraced frame is a story phenomenon involving the sum of the sway resistances of each column in the story and the sum of the factored gravity loads in the columns in that story. If each column in a story of an unbraced frame is designed to support its own  $P$  and  $P\Delta$  moment, then all the columns will buckle simultaneously (assumption 8). Under this condition, there is no interaction among the columns in the story; column sway instability and frame instability occur at the same time. Framing systems can be used that redistribute the story  $\Sigma P\Delta$  to the columns in that story in proportion to their individual stiffnesses. In an unbraced frame that contains columns that contribute little or nothing to the sway stiffness of the story, such columns can be designed using  $K = 1.0$  (leaning columns), but the other columns in the story must be designed to support the destabilizing  $P\Delta$  moments developed from the loads on such columns. Similarly, more highly loaded columns in a story will redistribute some of their  $P\Delta$  moments to more lightly loaded columns.

Two methods for evaluating story frame stability are recognized, the story stiffness method (LeMessurier, 1976 and 1977) and the story buckling method (Yura, 1971) as reflected in Equations C1-4 and C1-5, respectively. For an individual column in the sway-resisting system,

$$\lambda_c^2 = \frac{(KL)^2}{\pi^2 EI} A_g F_y = \frac{P_y}{P_{e2}}$$

To account for the redistribution of the  $P\Delta$  moments within a story, determine  $P_n$  for an individual column in the sway-resisting system by substituting  $\lambda'_c$  for  $\lambda_c$ , where

$$\lambda'_c = \frac{K'L}{\pi r} \sqrt{\frac{F_y}{E}}$$

and  $K'$  is given below.

For the story stiffness method

$$K' = \sqrt{\frac{P_e}{0.822 P_u} \sum P_u \left( \frac{\Delta_{oh}}{\sum HL} \right)} \quad (\text{C-C2-5})$$

where

$$P_e = \frac{\pi^2 EI}{L^2}.$$

The 0.822 factor is the ratio of the lateral column shear force per radian of drift to the buckling load of a sway permitted column with large end restraint,  $G = 0$ . This factor will approach 1.0 for more flexible systems or systems with a large percent-

age of leaner columns. Less conservative methods are given in ASCE Task Committee on Effective Length (1997). The term,

$$\Sigma P_u \left( \frac{\Delta_{oh}}{\Sigma HL} \right)$$

is a constant for all rigidly connected columns in a story and is the same term used in Equation C1-4.

For the story buckling approach

$$K' = \sqrt{\frac{P_e}{P_u} \left( \frac{\Sigma P_u}{\Sigma P_{e2}} \right)} \quad (\text{C-C2-6})$$

where  $(\Sigma P_u / \Sigma P_{e2})$  is the same term found in Equation C1-5 and is a constant for all rigidly-connected columns in a story.

The value of  $P_n$  calculated using  $K'$  by either method cannot be taken greater than  $P_n$  based on sidesway inhibited buckling. Additional simplified methods were given in the previous edition of this commentary. Although they are not repeated here, they are equally valid within the limitations placed on them in that edition. A comparison of the influence of those methods may be found in Geschwindner (1994).

The theoretical  $K$ -factors that are less than 1.0 (Cases (a) and (b) in Table C-C2.1 and the sidesway inhibited alignment chart in Figure C-C2.2a), are based on the assumption that there is no relative lateral movement of the ends of the column. When bracing is proportioned by the requirements of Section C3,  $K$  equal to 1.0 should be used, not values less than 1.0, because a small relative movement of the brace points is anticipated.

### C3. STABILITY BRACING

#### 1. Scope

The design requirements consider two general types of bracing systems, relative and nodal, as shown in Fig. C-C3.1. A relative column brace system (such as diagonal bracing or shear walls) is attached to two locations along the length of the column that defines the unbraced length. The relative brace system shown consists of the diagonal and the strut that controls the movement at one end of the unbraced length, A, with respect to the other end of the unbraced length, B. The diagonal and the strut both contribute to the strength and stiffness of the relative brace system. However, when the strut is a floor beam, its stiffness is large compared to the diagonal so the diagonal controls the strength and stiffness of the relative brace. A nodal brace controls the movement only at the particular brace point, without direct interaction with adjacent braced points. Therefore to define an unbraced length there must be additional adjacent brace points as shown in Figure C-C3.1. The two nodal column braces at C and D that are attached to the rigid abutment define the unbraced length for which  $K = 1.0$  can be used. For beams a cross frame between two adjacent beams at midspan is a nodal brace because it prevents twist of the beams only at the particular cross frame location. The unbraced length is half the span length. The twist at the ends of the two beams is prevented by the beam-to-column connections at the end supports. Similarly, a nodal lateral brace attached at midspan to the top

flange of the beams and a rigid support assumes that there is no lateral movement at the column locations.

The brace requirements will enable a member to potentially reach a maximum load based on the unbraced length between the brace points and  $K = 1.0$ . This is not the same as the no-sway buckling load as illustrated in Figure C-C3.2 for the braced cantilever. The critical stiffness is  $1.0 P_e/L$ , corresponding to  $K = 1.0$ . A brace with five times this stiffness is necessary to reach 95 percent of the  $K = 0.7$  limit. Theoretically, an infinitely stiff brace is required to reach the no-sway limit. Bracing required to reach specified rotation capacities or ductility limits is beyond the scope of these recommendations. Member inelasticity has no significant effect on the brace requirements (Yura, 1995).

Winter (1958 and 1960) developed the concept of dual criterion for bracing design, strength and stiffness. The brace force is a function of the initial column out-of-straightness,  $\Delta_o$ , and the brace stiffness,  $\beta$ . For a relative brace system, the relationship between column load, brace stiffness and sway displacement is shown in Figure C-C3.3. If  $\beta = \beta_i$ , the critical brace stiffness for a perfectly plumb member, then  $P = P_e$  only if the sway deflection gets very large. Unfortunately, such large dis-

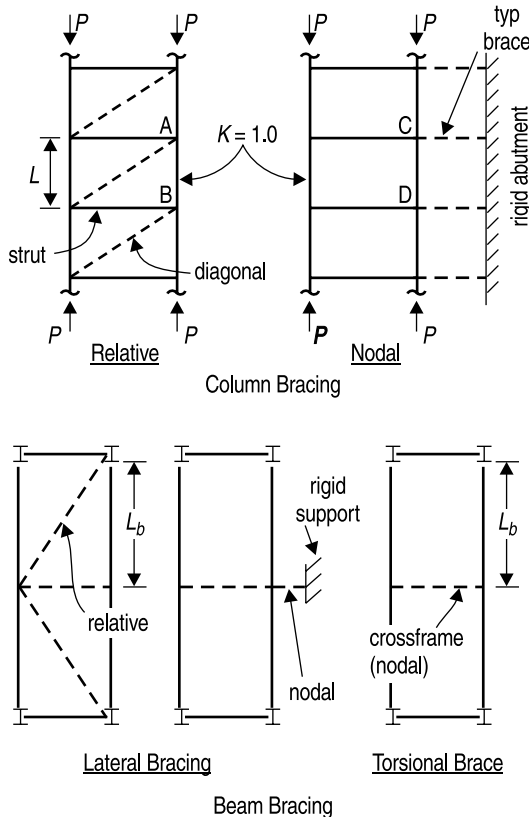

Fig. C-C3.1. Types of bracing.

placements produce large brace forces. For practical design,  $\Delta$  must be kept small at the factored load level.

The brace stiffness requirements,  $\beta_{br}$ , for frames, columns, and beams were chosen as twice the critical stiffness. The  $\phi = 0.75$  specified for all brace stiffness requirements is consistent with the implied resistance factor for elastic Euler column buckling, i.e.  $0.877 \times \phi_c = 0.75$ . For the relative brace system shown in Figure C-C3.3,  $\beta_{br} = 2\beta_i$  gives  $P_{br} = 0.4\% P_e$  for  $\Delta_o = 0.002L$ . If the brace stiffness provided,  $\beta_{act}$ , is different from the requirement, then the brace force or brace moment can be multiplied by the following factor:

$$\frac{1}{2 - \frac{\beta_{br}}{\beta_{act}}} \quad (C-C3-1)$$

No  $\phi$  is specified in the brace strength requirements since  $\phi$  is included in the component design strength provisions in other chapters of this Specification.

The initial displacement,  $\Delta_o$ , for relative and nodal braces is defined with respect to the distance between adjacent braces, as shown in Figure C-C3.4. The initial  $\Delta_o$  is a displacement from the straight position at the brace points caused by sources other than brace elongations from gravity loads or compressive forces, such as displacements caused by wind or other lateral forces, erection tolerances, column shorten-

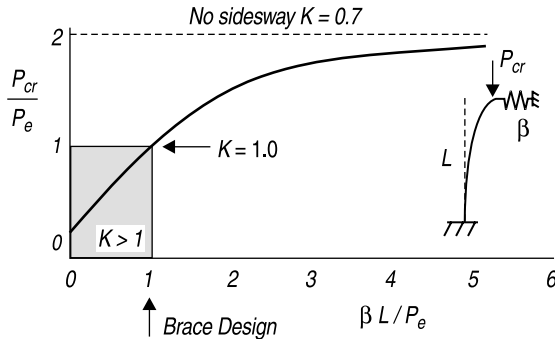

Fig. C-C3.2. Braced cantilever.

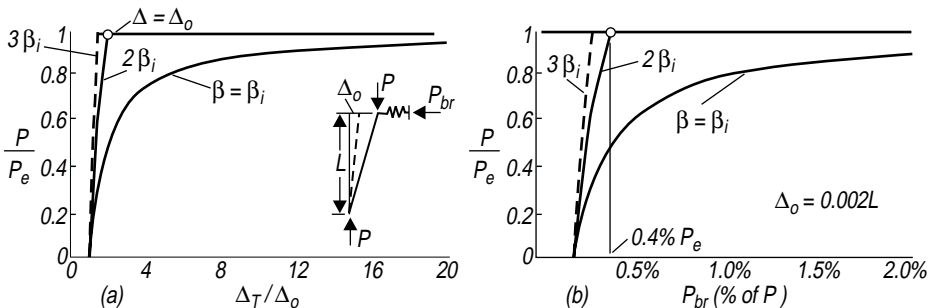

Fig. C-C3.3. Effect of initial out-of-plumbness.

ing, etc. The brace force recommendations for frames, columns and beam lateral bracing are based on an assumed  $\Delta_o = 0.002L$ , where  $L$  is the distance between adjacent brace points. For torsional bracing of beams, an initial twist angle,  $\theta_o$ , is assumed where  $\theta_o = 0.002L/h_o$ , and  $h_o$  is the distance between flange centroids. For other  $\Delta_o$  and  $\theta_o$  values, use direct proportion to modify the brace strength requirements,  $P_{br}$  and  $M_{br}$ . For cases where it is unlikely that all columns in a story are out-of-plumb in the same direction, Chen and Tong (1994) recommend an average  $\Delta_o = 0.002L / \sqrt{n_o}$  where  $n_o$  columns, each with a random  $\Delta_o$ , are to be stabilized by the brace system. This reduced  $\Delta_o$  would be appropriate when combining the stability brace forces with wind and seismic forces.

Brace connections, if they are flexible or can slip, should be considered in the evaluation of the bracing stiffness as follows:

$$\frac{1}{\beta_{act}} = \frac{1}{\beta_{conn}} + \frac{1}{\beta_{brace}} \quad (\text{C-C3-2})$$

The brace system stiffness,  $\beta_{act}$ , is less than the smaller of the connection stiffness,  $\beta_{conn}$ , or the stiffness of the brace,  $\beta_{brace}$ . Slip in connections with standard holes need not be considered except when only a few bolts are used. When evaluating the bracing of rows of columns or beams, consideration must be given to the accumulation of the brace forces along the length of the brace that results in a different displacement at each beam or column location. In general, brace forces can be minimized by increasing the number of braced bays and using stiff braces.

### 3. Columns

For nodal column bracing, the critical stiffness is a function of the number of intermediate braces (Winter, 1958 and 1960). For one intermediate brace,  $\beta_i = 2P/L_b$ , and for many braces  $\beta_i = 4P/L_b$ . The relationship between the critical stiffness and the number of braces,  $n$ , can be approximated (Yura, 1995) as  $\beta_i = N_i P/L_b$ , where  $N_i = 4 - 2/n$ . The most severe case (many braces) was adopted for the brace stiffness requirement,  $\beta_{br} = 2 \times 4P/L_b$ . The brace stiffness, Equation C3-6, can be reduced by the ratio,  $N_i/4$ , to account for the actual number of braces.

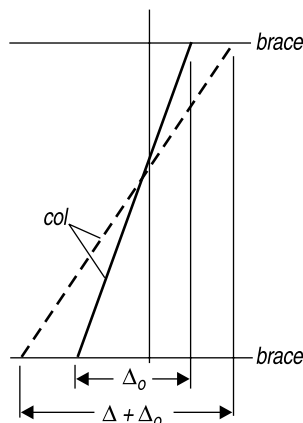

Fig. C-C3.4. Definitions.

The unbraced length,  $L_b$ , in Equations C3-4 and C3-6 is assumed to be equal to the length  $L_q$  that enables the column to reach  $P_u$ . When the actual bracing spacing is less than  $L_q$ , the calculated required stiffness may become quite conservative since the stiffness equations are inversely proportional to  $L_b$ . In such cases,  $L_q$  can be substituted for  $L_b$ . For example, a W12×53 (W310×79) with  $P_u = 400$  kips (1 780 kN) can have a maximum unbraced length of 14 ft (4.3 m) for A36 (A36M) steel. If the actual bracing spacing is 8 ft (2.4 m), then 14 ft (4.3 m) may be used in Equations C3-4 and C3-6 to determine the required stiffness.

Winter's rigid model would derive a brace force of 0.8 percent  $P_u$  which accounts only for lateral displacement force effects. To account for the additional force due to member curvature, this theoretical force has been increased to one percent  $P_u$ .

#### 4. Beams

Beam bracing must prevent twist of the section, not lateral displacement. Both lateral bracing (for example, joists attached to the compression flange of a simply supported beam) and torsional bracing (for example, a cross frame or diaphragm between adjacent girders) can effectively control twist. Lateral bracing systems that are attached near the beam centroid are ineffective. For beams with double curvature, the inflection point can not be considered a brace point because twist occurs at that point (Galambos, 1998). A lateral brace on one flange near the inflection point also is ineffective. In double curvature cases the lateral brace near the inflection point must be attached to both flanges to prevent twist, or torsional bracing must be used. The beam brace requirements are based on the recommendations by Yura (1993).

##### 4a. Lateral Bracing

For lateral bracing, the following stiffness requirement was derived following Winter's approach:

$$\beta_{br} = 2N_i (C_b P_f) C_t C_d / \phi L_b \quad (\text{C-C3-3})$$

where

$N_i = 1.0$  for relative bracing

$= (4-2/n)$  for discrete bracing

$n =$  number of intermediate braces

$P_f =$  beam compressive flange force

$= \pi^2 EI_{yc} / L_b^2$

$I_{yc} =$  out-of-plane moment of inertia of the compression flange

$C_b =$  moment modifier from Chapter F

$C_t =$  accounts for top flange loading (use  $C_t = 1.0$  for centroidal loading)  
 $= 1 + (1.2/n)$

$C_d =$  double curvature factor (compression in both flanges)  
 $= 1 + (M_S / M_L)^2$

$M_S =$  smallest moment causing compression in each flange

$M_L =$  largest moment causing compression in each flange

The  $C_d$  factor varies between 1.0 and 2.0 and is applied only to the brace closest to the inflection point. The term  $(2N_i C_t)$  can be conservatively approximated as 10 for any number of nodal braces and 4 for relative bracing and  $(C_b P_f)$  can be approximated by  $M_u / h$  which simplifies Equation C-C3-3 to the stiffness requirements



given by Equations C3-8 and C3-10. Equation C-C3-3 can be used in lieu of Equations C3-8 and C3-10.

The brace strength requirement for relative bracing is

$$P_{br} = 0.004 M_u C_t C_d / h_o \quad (\text{C-C3-4a})$$

and for nodal bracing

$$P_{br} = 0.01 M_u C_t C_d / h_o \quad (\text{C-C3-4b})$$

They are based on an assumed initial lateral displacement of the compression flange of  $0.002L_b$ . The brace strength requirements of Equations C3-7 and C3-9 are derived from Equations C-C3-4a and C-C3-4b assuming top flange loading ( $C_t = 2$ ). Equations C-C3-4a and C-C3-4b can be used in lieu of Equations C3-7 and C3-9 respectively.

#### 4b. Torsional Bracing

Torsional bracing can either be attached continuously along the length of the beam (for example, metal deck or slabs) or be located at discrete points along the length of the member (for example, cross frames). Torsional bracing attached to the tension flange is just as effective as a brace attached at mid depth or the compression flange. Partially restrained connections can be used if their stiffness is considered in evaluating the torsional brace stiffness.

The torsional brace requirements are based on the buckling strength of a beam with a continuous torsional brace along its length developed by Taylor and Ojalvo (1966) and modified for cross-section distortion by Yura (1993).

$$M_u \leq M_{cr} = \sqrt{(C_{bu} M_o)^2 + \frac{C_b^2 EI_y \bar{\beta}_T}{2C_{tt}}} \quad (\text{C-C3-5})$$

The term  $(C_{bu} M_o)$  is the buckling strength of the beam without torsional bracing.  $C_{tt} = 1.2$  when there is top flange loading and  $C_{tt} = 1.0$  for centroidal loading.  $\bar{\beta}_T = n\beta_T / L$  is the continuous torsional brace stiffness per unit length or its equivalent when  $n$  nodal braces, each with a stiffness  $\beta_T$ , are used along the span  $L$  and the 2 accounts for initial out-of-straightness. Neglecting the unbraced beam buckling term gives a conservative estimate of the torsional brace stiffness requirement (Equation C3-13). A more accurate estimate of the brace requirements can be obtained by replacing  $M_u$  with  $(M_u - C_{bu} M_o)$  in Equations C3-11 and C3-13. The  $\beta_{sec}$  term in Equations C3-12, C3-14 and C3-15 accounts for cross-section distortion. A web stiffener at the brace point reduces cross-sectional distortion and improves the effectiveness of a torsional brace. When a cross frame is attached near both flanges or a diaphragm is approximately the same depth as the girder, then web distortion will be insignificant so  $\beta_{sec}$  equals infinity. The required bracing stiffness,  $\beta_{Tb}$ , given by Equation C3-12 was obtained by solving the following expression that represents the brace system stiffness including distortion effects:

$$\frac{1}{\beta_T} = \frac{1}{\beta_{Tb}} + \frac{1}{\beta_{sec}} \quad (\text{C-C3-6})$$

The brace moment requirements are based on an assumed initial twist of  $0.002L_b / h_o$ .

Parallel chord trusses with both chords extended to the end of the span and attached to supports can be treated like beams. In Equations C3-7 through C3-11,  $M_u$  may be taken as the maximum compressive chord force times the depth of the truss to determine the brace strength and stiffness requirements. Cross-section distortion effects,  $\beta_{sec}$ , need not be considered when full-depth cross frames are used for bracing. When either chord does not extend to the end of the span, consideration should be given to control twist near the ends of the span by the use of cross frames or ties.

# CHAPTER D

## TENSION MEMBERS

### D1. DESIGN TENSILE STRENGTH

Due to strain hardening, a ductile steel bar loaded in axial tension can resist, without fracture, a force greater than the product of its gross area and its coupon yield stress. However, excessive elongation of a tension member due to uncontrolled yielding of its gross area not only marks the limit of its usefulness, but can precipitate failure of the structural system of which it is a part. On the other hand, depending upon the reduction of area and other mechanical properties of the steel, the member can fail by fracture of the net area at a load smaller than required to yield the gross area. Hence, general yielding of the gross area and fracture of the net area both constitute failure limit states. The relative values of  $\phi_t$  given for yielding and fracture reflect the same basic difference in factor of safety as between design of members and design of connections in the AISC ASD Specification.

The length of the member in the net area is negligible relative to the total length of the member. As a result, the strain hardening condition is quickly reached and yielding of the net area at fastener holes does not constitute a limit state of practical significance.

### D2. BUILT-UP MEMBERS

The slenderness ratio  $L / r$  of tension members other than rods, HSS, or straps should preferably not exceed the limiting value of 300. This slenderness limit recommended for tension members is not essential to the structural integrity of such members; it merely assures a degree of stiffness such that undesirable lateral movement (“slapping” or vibration) will be unlikely.

See Section B7 and Commentary Section E4.

### D3. PIN-CONNECTED MEMBERS AND EYEBARS

Forged eyebars have generally been replaced by pin-connected plates or eyebars thermally cut from plates. Provisions for the proportioning of eyebars contained in the LRFD Specification are based upon standards evolved from long experience with forged eyebars. Through extensive destructive testing, eyebars have been found to provide balanced designs when they are thermally cut instead of forged. The somewhat more conservative rules for pin-connected members of nonuniform cross section and those not having enlarged “circular” heads are likewise based on the results of experimental research (Johnston, 1939).

Somewhat stockier proportions are provided for eyebars and pin-connected members fabricated from steel having a yield stress greater than 70 ksi (485 MPa), in order to eliminate any possibility of their “dishing” under the higher design stress.

## CHAPTER E

### COLUMNS AND OTHER COMPRESSION MEMBERS

#### E1. EFFECTIVE LENGTH AND SLENDERNESS LIMITATIONS

##### 1. Effective Length

The Commentary on Section C2 regarding frame stability and effective length factors applies here. Further analytic methods, formulas, charts, and references for the determination of effective length are provided in Chapter 15 of the SSRC Guide (Galambos, 1998).

##### 2. Design by Plastic Analysis

The limitation on  $\lambda_c$  is essentially the same as that for  $l/r$  in Chapter N of the 1989 AISC Specification—Allowable Stress Design and Plastic Design.

#### E2. DESIGN COMPRESSIVE STRENGTH FOR FLEXURAL BUCKLING\*

Equations E2-2 and E2-3 are based on a reasonable conversion of research data into design equations. Conversion of the allowable stress design (ASD) equations which was based on the CRC—Column Research Council—curve (Galambos, 1998) was found to be cumbersome for two reasons. The first was the nature of the ASD variable safety factor. Secondly, the difference in philosophical origins of the two design procedures requires an assumption of a live load-to-dead load ratio ( $L/D$ ).

Since all  $L/D$  ratios could not be considered, a value of approximately 1.1 at  $\lambda$  equal to 1.0 was used to calibrate the exponential equation for columns with the lower range of  $\lambda$  against the appropriate ASD provision. The coefficient with the Euler equation was obtained by equating the ASD and LRFD expressions at  $\lambda$  of 1.5.

Equations E2-2 and E2-3 are essentially the same curve as column-strength curve 2P of the Structural Stability Research Council which is based on an initial out-of-straightness curve of  $l/1500$  (Bjorhovde, 1972 and 1988; Galambos, 1998; Tide, 1985).

It should be noted that this set of column equations has a range of reliability ( $\beta$ ) values. At low- and high-column slenderness,  $\beta$  values exceeding 3.0 and 3.3 respectively are obtained compared to  $\beta$  of 2.60 at  $L/D$  of 1.1. This is considered satisfactory, since the limits of out-of-straightness combined with residual stress have not been clearly established. Furthermore, there has been no history of unacceptable

---

\*For tapered members see Commentary Appendix F3.

behavior of columns designed using the ASD procedure. This includes cases with  $L/D$  ratios greater than 1.1.

Equations E2-2 and E2-3 can be restated in terms of the more familiar slenderness ratio  $Kl/r$ . First, Equation E2-2 is expressed in exponential form,

$$F_{cr} = \left[ \exp(-0.419\lambda_c^2) \right] F_y \quad (\text{C-E2-1})$$

Note that  $\exp(x)$  is identical to  $e^x$ . Substitution of  $\lambda_c$  according to definition of  $\lambda_c$  in Section E2 gives,

$$\text{For } \frac{Kl}{r} \leq 4.71 \sqrt{\frac{E}{F_y}}$$

$$F_{cr} = \left\{ \exp \left[ -0.0424 \frac{F_y}{E} \left( \frac{Kl}{r} \right)^2 \right] \right\} F_y \quad (\text{C-E2-2})$$

$$\text{For } \frac{Kl}{r} > 4.71 \sqrt{\frac{E}{F_y}}$$

$$F_{cr} = \frac{0.877\pi^2 E}{\left( \frac{Kl}{r} \right)^2} \quad (\text{C-E2-3})$$

### E3. DESIGN COMPRESSIVE STRENGTH FOR FLEXURAL-TORSIONAL BUCKLING

Torsional buckling of symmetric shapes and flexural-torsional buckling of unsymmetric shapes are failure modes usually not considered in the design of hot-rolled columns. They generally do not govern, or the critical load differs very little from the weak axis planar buckling load. Such buckling loads may, however, control the capacity of symmetric columns made from relatively thin plate elements and unsymmetric columns. Design equations for determining the strength of such columns are given in Appendix E3. The AISC Design Guide, *Torsional Analysis of Structural Steel Members* (Seaburg and Carter, 1997) provides an overview of the fundamentals and basic theory of torsional loading for structural steel members. Design examples are also included.

Tees that conform to the limits in Table C-E3.1 need not be checked for flexural-torsional buckling.

A simpler and more accurate design strength for the special case of tees and double-angles is based on Galambos (1991) wherein the y-axis of symmetry flexural-buckling strength component is determined directly from the column formulas.

The separate AISC *Specification for Load and Resistance Factor Design of Single-Angle Members* contains detailed provisions not only for the limit state of compression, but also for tension, shear, flexure, and combined forces.

**TABLE C-E3.1**  
**Limiting Proportions for Tees**

Shape	Ratio of Full Flange Width to Profile Depth	Ratio of Flange Thickness to Web or Stem Thickness
Built-up tees	≥ 0.50	≥ 1.25
Rolled tees	≥ 0.50	≥ 1.10

#### **E4. BUILT-UP MEMBERS**

Requirements for detailing and design of built-up members, which cannot be stated in terms of calculated stress, are based upon judgment and experience.

The longitudinal spacing of connectors connecting components of built-up compression members must be such that the slenderness ratio  $l/r$  of individual shapes does not exceed three-fourths of the slenderness ratio of the entire member. Additional requirements are imposed for built-up members consisting of angles. However, these minimum requirements do not necessarily ensure that the effective slenderness ratio of the built-up member is equal to that for the built-up member acting as a single unit. Section E4 gives formulas for modified slenderness ratios that are based on research and take into account the effect of shear deformation in the connectors (Zandonini, 1985). Equation E4-1 for snug-tight intermediate connectors is empirically based on test results (Zandonini, 1985). Equation E4-2 is derived from theory and verified by test data. In both cases the end connection must be welded or slip-critical bolted (Aslani and Goel, 1991). The connectors must be designed to resist the shear forces which develop in the buckled member. The shear stresses are highest where the slope of the buckled shape is maximum (Bleich, 1952).

Maximum fastener spacing less than that required for strength may be needed to ensure a close fit over the entire faying surface of components in continuous contact. Specific requirements are given for weathering steel members exposed to atmospheric corrosion (Brockenbrough, 1983).

The provisions governing the proportioning of perforated cover plates are based upon extensive experimental research (Stang and Jaffe, 1948).

# CHAPTER F

## BEAMS AND OTHER FLEXURAL MEMBERS

### F1. DESIGN FOR FLEXURE

#### 1. Yielding

The bending strength of a laterally braced compact section is the plastic moment  $M_p$ . If the shape has a large shape factor (ratio of plastic moment to the moment corresponding to the onset of yielding at the extreme fiber), significant inelastic deformation may occur at service load if the section is permitted to reach  $M_p$  at factored load. The limit of  $1.5M_y$  at factored load will control the amount of inelastic deformation for sections with shape factors greater than 1.5. This provision is not intended to limit the plastic moment of a hybrid section with a web yield stress lower than the flange yield stress. Yielding in the web does not result in significant inelastic deformations. In hybrid sections,  $M_y = F_{yf} S$ .

Lateral-torsional buckling cannot occur if the moment of inertia about the bending axis is equal to or less than the moment of inertia out of plane. Thus, for shapes bent about the minor axis and shapes with  $I_x = I_y$ , such as square or circular shapes, the limit state of lateral-torsional buckling is not applicable and yielding controls if the section is compact.

#### 2. Lateral-Torsional Buckling

##### 2a. Doubly Symmetric Shapes and Channels with $L_b \leq L_r$

The basic relationship between nominal moment  $M_n$  and unbraced length  $L_b$  is shown in Figure C-F1.1 for a compact section with  $C_b = 1.0$ . There are four principal zones defined on the basic curve by  $L_{pd}$ ,  $L_p$ , and  $L_r$ . Equation F1-4 defines the maximum unbraced length  $L_p$  to reach  $M_p$  with uniform moment. Elastic lateral-torsional buckling will occur when the unbraced length is greater than  $L_r$ , given by Equation F1-6. Equation F1-2 defines the inelastic lateral-torsional buckling as a straight line between the defined limits  $L_p$  and  $L_r$ . Buckling strength in the elastic region  $L_b > L_r$  is given by Equation F1-14 for I-shaped members.

For other moment diagrams, the lateral buckling strength is obtained by multiplying the basic strength by  $C_b$  as shown in Figure C-F1.1. The maximum  $M_n$ , however, is limited to  $M_p$ . Note that  $L_p$  given by Equation F1-4 is merely a definition which has physical meaning when  $C_b = 1.0$ . For  $C_b$  greater than 1.0, larger unbraced lengths are permitted to reach  $M_p$ , as shown by the curve for  $C_b > 1.0$ . For design, this length could be calculated by setting Equation F1-2 equal to  $M_p$  and solving this equation for  $L_b$  using the desired  $C_b$  value.

The equation

$$C_b = 1.75 + 1.05(M_1 / M_2) + 0.3(M_1 / M_2)^2 \leq 2.3 \quad (\text{C-F1-1})$$

has been used since 1961 to adjust the flexural-torsional buckling equation for variations in the moment diagram within the unbraced length. This equation is applicable only to moment diagrams that are straight lines between braced points. The equation provides a lower bound fit to the solutions developed by Salvadori (1956) which are shown in Figure C-F1.2. Another equation

$$C_b = \frac{1}{0.6 - 0.4 \frac{M_1}{M_2}} \leq 2.5 \tag{C-F1-2}$$

fits the average value theoretical solutions when the beams are bent in reverse curvature and also provides a reasonable fit to the theory. If the maximum moment

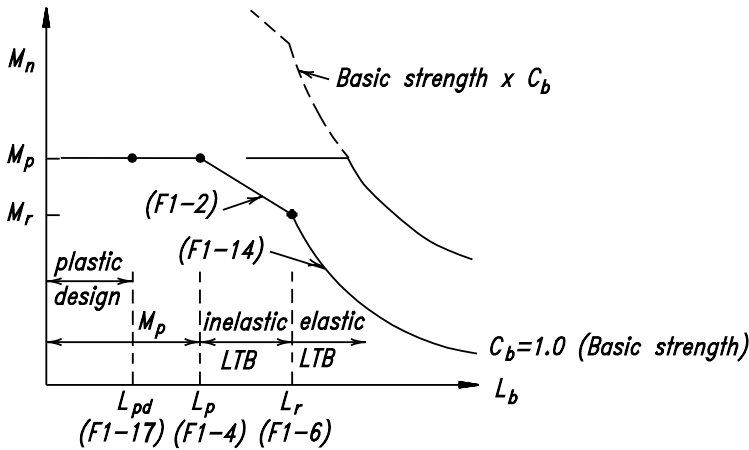

Fig. C-F1.1. Nominal moment as a function of unbraced length and moment gradient.

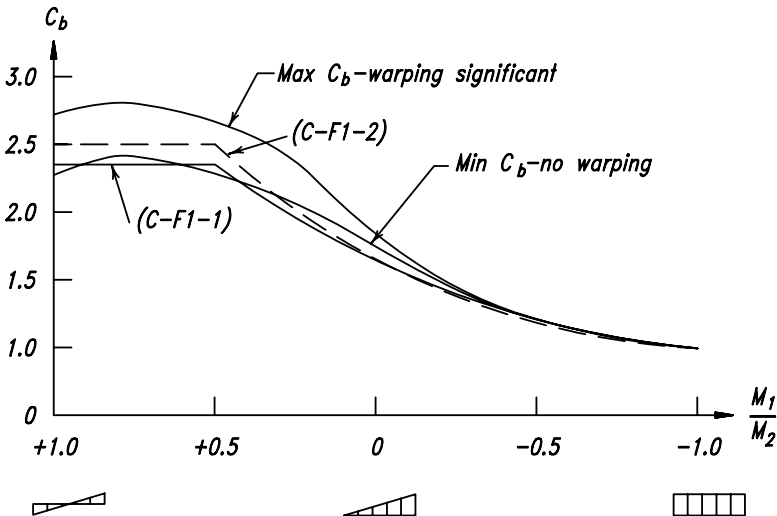

Fig. C-F1.2. Moment modifier  $C_b$  for beams.



within the unbraced segment is equal to or larger than the end moment,  $C_b = 1.0$  is used.

The equations above can be easily misinterpreted and misapplied to moment diagrams that are not straight within the unbraced segment. Kirby and Nethercot (1979) presented an equation which applies to various shapes of moment diagrams within the unbraced segment. Their equation has been adjusted slightly to the following

$$C_b = \frac{12.5M_{max}}{2.5M_{max} + 3M_A + 4M_B + 3M_C} \tag{C-F1-3}$$

This equation gives more accurate solutions for fixed-end beams, and the adjusted equation reduces exactly to Equation C-F1-2 for a straight line moment diagram in single curvature. The  $C_b$  equation used in the specification is shown in Figure C-F1.3 for straight line moment diagrams. Other moment diagrams along with exact theoretical solutions in the SSRC Guide (Galambos, 1998) show good comparison with the new equation. The absolute value of the three interior quarter-point moments plus the maximum moment, regardless of its location are used in the equation. The maximum moment in the unbraced segment is always used for comparison with the resistance. The length between braces, not the distance to inflection points, and  $C_b$  are used in the resistance equation.

It is still satisfactory to use the former  $C_b$  factor, Equation C-F1-1, for straight line moment diagrams within the unbraced length.

The elastic strength of hybrid beams is identical to homogeneous beams. The strength advantage of hybrid sections becomes evident only in the inelastic and plastic slenderness ranges.

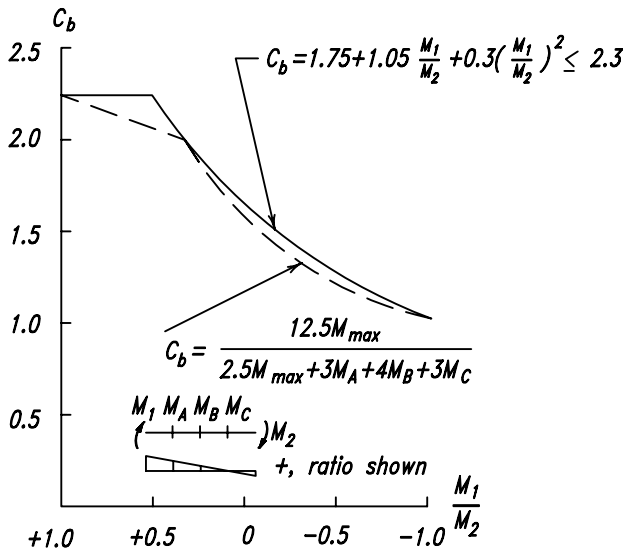

C-F1.3.  $C_b$  for a straight line moment diagram—prismatic beam.

## 2b. Doubly Symmetric Shapes and Channels with $L_b > L_r$

The equation given in the Specification assumes that the loading is applied along the beam centroidal axis. If the load is placed on the top flange and the flange is not braced, there is a tipping effect that reduces the critical moment; conversely, if the load is suspended from the bottom flange and is not braced, there is a stabilizing effect which increases the critical moment (Galambos, 1998). For unbraced top flange loading, the reduced critical moment may be conservatively approximated by setting the warping buckling factor  $X_2$  to zero.

An effective length factor of unity is implied in these critical moment equations to represent a worst case pinned-pinned unbraced segment. Including consideration of any end restraint of the adjacent segments on the critical segment can increase its buckling capacity. The effects of beam continuity on lateral-torsional buckling have been studied and a simple and conservative design method, based on the analogy of end-restrained nonsway columns with an effective length factor less than one, has been proposed (Galambos, 1998).

## 2c. Tees and Double-Angles

The lateral-torsional buckling strength (LTB) of singly symmetric tee beams is given by a fairly complex formula (Galambos, 1998). Equation F1-15 is a simplified formulation based on Kitipornchai and Trahair (1980). See also Ellifritt, Wine, Sputo, and Samuel (1992).

The  $C_b$  used for I-shaped beams is unconservative for tee beams with the stem in compression. For such cases  $C_b=1.0$  is appropriate. When beams are bent in reverse curvature, the portion with the stem in compression may control the LTB resistance even though the moments may be small relative to other portions of the unbraced length with  $C_b \approx 1.0$ . This is because the LTB strength of a tee with the stem in compression may be only about one-fourth of the capacity for the stem in tension. Since the buckling strength is sensitive to the moment diagram,  $C_b$  has been conservatively taken as 1.0. In cases where the stem is in tension, connection details should be designed to minimize any end restraining moments which might cause the stem to be in compression.

## 3. Design by Plastic Analysis

Equation F1-17 sets a limit on unbraced length adjacent to a plastic hinge for plastic analysis. There is a substantial increase in unbraced length for positive moment ratios (reverse curvature) because the yielding is confined to zones close to the brace points (Yura et al., 1978).

Equation F1-18 is an equation in similar form for solid rectangular bars and symmetric box beams. Equations F1-17 and F1-18 assume that the moment diagram within the unbraced length next to plastic hinge locations is reasonably linear. For nonlinear diagrams between braces, judgment should be used in choosing a representative ratio.

Equations F1-17 and F1-18 were developed to provide rotation capacities of at least 3.0, which are sufficient for most applications (Yura et al., 1978). When inelastic rotations of 7 to 9 are deemed appropriate in areas of high seismicity, as discussed in Commentary Section B5, Equation F1-17 would become:

$$L_{pd} = 0.086 \left( \frac{E}{F_y} \right) r_y \quad (\text{C-F1-4})$$

## F2. DESIGN FOR SHEAR

For unstiffened webs  $k_v = 5.0$ , therefore

$$1.10\sqrt{Ek_v / F_{yw}} = 2.45\sqrt{E / F_{yw}}, \text{ and } 1.37\sqrt{Ek_v / F_{yw}} = 3.07\sqrt{E / F_{yw}}$$

For webs with  $h/t_w \leq 1.10\sqrt{Ek_v / F_{yw}}$ , the nominal shear strength  $V_n$  is based on shear yielding of the web, Equation F2-1 and Equation A-F2-1. This  $h/t_w$  limit was determined by setting the critical stress causing shear buckling  $F_{cr}$  equal to the yield stress of the web  $F_{yw}$  in Equation 35 of Cooper, Galambos, and Ravindra (1978) and Timoshenko and Gere (1961). When  $h/t_w > 1.10\sqrt{Ek_v / F_{yw}}$ , the web shear strength is based on buckling. Basler (1961) suggested taking the proportional limit as 80 percent of the yield stress of the web. This corresponds to  $h/t_w = (1.10/0.8)\sqrt{Ek_v / F_{yw}}$ . Thus, when  $h/t_w > 1.37\sqrt{Ek_v / F_{yw}}$ , the web strength is determined from the elastic buckling stress given by Equation 6 of Cooper et al. (1978) and Timoshenko and Gere (1961):

$$F_{cr} = \frac{\pi^2 Ek_v}{12(1-\nu^2)(h/t_w)^2} \quad (\text{C-F2-1})$$

The nominal shear strength, given by Equation F2-3 and A-F2-3, was obtained by multiplying  $F_{cr}$  by the web area and using  $E = 29,000$  ksi (200 000 MPa) and  $\nu = 0.3$ . A straight line transition, Equation F2-2 and A-F2-2, is used between the limits  $1.10\sqrt{Ek_v / F_{yw}}$  and  $1.37\sqrt{Ek_v / F_{yw}}$ .

The shear strength of flexural members follows the approach used in the AISC ASD Specification, except for two simplifications. First, the expression for the plate buckling coefficient  $k_v$  has been simplified; it corresponds to that given by AASHTO *Standard Specification for Highway Bridges* (1996). The earlier expression for  $k_v$  was a curve fit to the exact expression; the new expression is just as accurate. Second, the alternate method (tension field action) for web shear strength is placed in Appendix G because it was desired that only one method appear in the main body of the Specification with alternate methods given in the Appendix. When designing plate girders, thicker unstiffened webs will frequently be less costly than lighter stiffened web designs because of the additional fabrication. If a stiffened girder design has economic advantages, the tension field method in Appendix G will require fewer stiffeners.

The equations in this section were established assuming monotonically increasing loads. If a flexural member is subjected to load reversals causing cyclic yielding over large portions of a web, such as may occur during a major earthquake, special design considerations may apply (Popov, 1980).

## F4. BEAMS AND GIRDERS WITH WEB OPENINGS

Web openings in structural floor members may be necessary to accommodate various mechanical, electrical, and other systems. Strength limit states, including local

buckling of the compression flange, web, and tee-shaped compression zone above or below the opening, lateral buckling and moment-shear interaction, or serviceability may control the design of a flexural member with web openings. The location, size, and number of openings are important and empirical limits for them have been identified. One general procedure for assessing these effects and the design of any needed reinforcement for both steel and composite beams is given in Darwin (1990) and in ASCE Task Committee on Design Criteria for Composite Structures in Steel and Concrete (1992 and 1992a).

# CHAPTER H

## MEMBERS UNDER COMBINED FORCES AND TORSION

### H1. SYMMETRIC MEMBERS SUBJECT TO BENDING AND AXIAL FORCE

Equations H1-1a and H1-1b are simplifications and clarifications of similar equations used in the AISC ASD Specification since 1961. Previously, both equations had to be checked. In the new formulation the applicable equation is governed by the value of the first term,  $P_u/\phi P_n$ . For bending about one axis only, the equations have the form shown in Figure C-H1.1.

The first term  $P_u/\phi P_n$  has the same significance as the axial load term  $f_a/F_a$  in Equations H1-1 of the AISC ASD Specification. This means that for members in compression  $P_n$  must be based on the largest effective slenderness ratio  $Kl/r$ . In the development of Equations H1-1a and H1-1b, a number of alternative formulations were compared to the exact inelastic solutions of 82 sidesway cases reported in Kanchanalai (1977). In particular, the possibility of using  $Kl/r$  as the actual column length ( $K = 1$ ) in determining  $P_n$ , combined with an elastic second order moment  $M_u$ , was studied. In those cases where the true  $P_n$  based on  $Kl/r$ , with  $K = 1.0$ , was in the inelastic range, the errors proved to be unacceptably large without the additional check that  $P_u \leq \phi_c P_n$ ,  $P_n$  being based on effective length. Although deviations from exact solutions were reduced, they still remained high.

In summary, it is not possible to formulate a safe general interaction equation for compression without considering effective length directly (or indirectly by a sec-

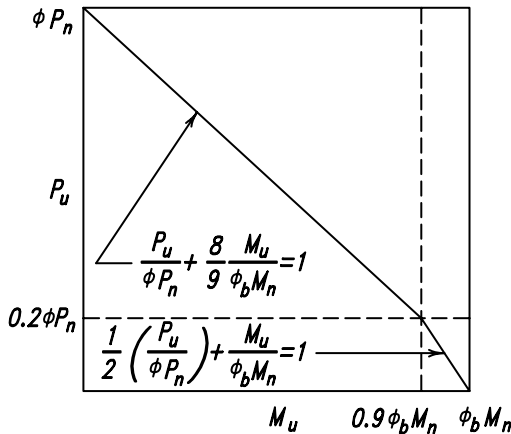

Fig. C-H1.1. Beam-column interaction equations.

ond equation). Therefore, the requirement that the nominal compressive strength  $P_n$  be based on the effective length  $KL$  in the general equation is continued in the LRFD Specification as it has been in the AISC ASD Specification since 1961. It is not intended that these provisions be applicable to limit nonlinear secondary flexure that might be encountered in large amplitude earthquake stability design (ATC, 1978).

The defined term  $M_n$  is the maximum moment in a member. In the calculation of this moment, inclusion of beneficial second order effects of tension is optional. But consideration of detrimental second order effects of axial compression and translation of gravity loads is required. Provisions for calculation of these effects are given in Chapter C.

The interaction equations in Appendix H3 have been recommended for biaxially loaded H and wide flange shapes in Galambos (1998) and Springfield (1975). These equations which can be used only in braced frames represent a considerable liberalization over the provisions given in Section H1; it is, therefore, also necessary to check yielding under service loads, using the appropriate load and resistance factors for the serviceability limit state in Equation H1-1a or H1-1b with  $M_{ux} = S_x F_y$  and  $M_{uy} = S_y F_y$ . Appendix H3 also provides interaction equations for rectangular box-shaped beam-columns. These equations are taken from Zhou and Chen (1985).

## **H2. UNSYMMETRIC MEMBERS AND MEMBERS UNDER TORSION AND COMBINED TORSION, FLEXURE, SHEAR, AND/OR AXIAL FORCE**

This section deals with types of cross sections and loadings not covered in Section H1, especially where torsion is a consideration. For such cases it is recommended to perform an elastic analysis based on the theoretical numerical methods available from the literature for the determination of the maximum normal and shear stresses, or for the elastic buckling stresses. In the buckling calculations an equivalent slenderness parameter is determined for use in Equation E2-2 or E2-3, as follows:

$$\lambda_e = \sqrt{F_y / F_e}$$

where  $F_e$  is the elastic buckling stress determined from a stability analysis. This procedure is similar to that of Appendix E3.

For the analysis of members with open sections under torsion refer to AISC (1997).

# CHAPTER I

## COMPOSITE MEMBERS

### II. DESIGN ASSUMPTIONS AND DEFINITIONS

*Force Determination.* Loads applied to an unshored beam before the concrete has hardened are resisted by the steel section alone, and only loads applied after the concrete has hardened are considered as resisted by the composite section. It is usually assumed for design purposes that concrete has hardened when it attains 75 percent of its design strength. In beams properly shored during construction, all loads may be assumed as resisted by the composite cross section. Loads applied to a continuous composite beam with shear connectors throughout its length, after the slab is cracked in the negative moment region, are resisted in that region by the steel section and by properly anchored longitudinal slab reinforcement.

For purposes of plastic analysis all loads are considered resisted by the composite cross section, since a fully plastic strength is reached only after considerable yielding at the locations of plastic hinges.

*Elastic Analysis.* The use of constant stiffness in elastic analyses of continuous beams is analogous to the practice in reinforced concrete design. The stiffness calculated using a weighted average of moments of inertia in the positive moment region and negative moment regions may take the following form:

$$I_t = aI_{pos} + bI_{neg}$$

where

$I_{pos}$  = effective moment of inertia for positive moment, in.<sup>4</sup> (mm<sup>4</sup>)

$I_{neg}$  = effective moment of inertia for negative moment, in.<sup>4</sup> (mm<sup>4</sup>)

The effective moment of inertia shall be based on the cracked transformed section considering degree of composite actions. For continuous beams subjected to gravity loads only, the value of  $a$  may be taken as 0.6 and the value of  $b$  may be taken as 0.4. For the case of composite beams in moment resisting frames, the value of  $a$  and  $b$  may be taken as 0.5.

*Plastic Analysis.* For composite beams with shear connectors, plastic analysis may be used only when the steel section in the positive moment region has a compact web, i.e.,  $h/t_w \leq 3.76\sqrt{E/F_{yf}}$ , and when the steel section in the negative moment region is compact, as required for steel beams alone. No compactness limitations are placed on encased beams, but plastic analysis is permitted only if the direct contribution of concrete to the strength of sections is neglected; the concrete is relied upon only to prevent buckling.

*Plastic Stress Distribution for Positive Moment.* Plastic stress distributions are

described in Commentary Section I3, and a discussion of the composite participation of slab reinforcement is presented.

*Plastic Stress Distribution for Negative Moment.* Plastic stress distributions are described in Commentary Section I3.

*Elastic Stress Distribution.* The strain distribution at any cross section of a composite beam is related to slip between the structural steel and concrete elements. Prior to slip, strain in both steel and concrete is proportional to the distance from the neutral axis for the elastic transformed section. After slip, the strain distribution is discontinuous, with a jump at the top of the steel shape. The strains in steel and concrete are proportional to distances from separate neutral axes, one for steel and the other for concrete.

*Fully Composite Beam.* Either the tensile yield strength of the steel section or the compressive stress of the concrete slab governs the maximum flexural strength of a fully composite beam subjected to a positive moment. The tensile yield strength of the longitudinal reinforcing bars in the slab governs the maximum flexural strength of a fully composite beam subjected to a negative moment. When shear connectors are provided in sufficient numbers to fully develop this maximum flexural strength, any slip that occurs prior to yielding is minor and has negligible influence both on stresses and stiffness.

*Partially Composite Beam.* The effects of slip on elastic properties of a partially composite beam can be significant and should be accounted for in calculations of deflections and stresses at service loads. Approximate elastic properties of partially composite beams are given in Commentary Section I3. For simplified design methods, see Hansell, Galambos, Ravindra, and Viest (1978).

*Concrete-Encased Beam.* When the dimensions of a concrete slab supported on steel beams are such that the slab can effectively serve as the flange of a composite T-beam, and the concrete and steel are adequately tied together so as to act as a unit, the beam can be proportioned on the assumption of composite action.

Two cases are recognized: fully encased steel beams, which depend upon natural bond for interaction with the concrete, and those with mechanical anchorage to the slab (shear connectors), which do not have to be encased.

## **I2. COMPRESSION MEMBERS**

### **1. Limitations**

- (1) The lower limit of four percent on the cross-sectional area of structural steel differentiates between composite and reinforced concrete columns. If the area is less than four percent, a column with a structural steel core should be designed as a reinforced concrete column.
- (2) The specified minimum quantity of transverse and longitudinal reinforcement in the encasement should be adequate to prevent severe spalling of the surface concrete during fires.
- (3) Very little of the supporting test data involved concrete strengths in excess of 6 ksi (41 MPa), even though the cylinder strength for one group of four columns was 9.6 ksi (66 MPa). Normal weight concrete is believed to have been used in all tests. Thus, the upper limit of concrete strength is specified as 8 ksi (55



MPa) for normal weight concrete. A lower limit of 3 ksi (21 MPa) is specified for normal weight concrete and 4 ksi (28 MPa) for lightweight concrete to encourage the use of good quality, yet readily available, grades of structural concrete.

- (4) In addition to the work of Bridge and Roderick (1978), SSRC Task Group 20 (1979), and Galambos and Chapuis (1980), recent work by Kenny, Bruce, and Bjorhovde (1994) has shown that due to concrete confinement effects, the previous limitation of 55 ksi (380 MPa) for the maximum steel yield stress is highly restrictive. Further, the most commonly used reinforcing steel grade has a yield stress of 60 ksi (415 MPa). The increase is therefore a rational recognition of material properties and structural behavior.

The 60 ksi (415 MPa) limitation for the yield stress is very conservative for tubular composite columns, where the concrete confinement provided by the tube walls is very significant. Kenny et al. have proposed raising the value of  $F_y$  for such columns to whatever the yield stress is for the steel grade used, but not higher than 80 ksi (550 MPa).

- (5) The specified minimum wall thicknesses are identical to those in the 1995 ACI Building Code (1995). The purpose of this provision is to prevent buckling of the steel pipe or HSS before yielding.

## 2. Design Strength

The procedure adopted for the design of axially loaded composite columns is described in detail in Galambos and Chapuis (1980). It is based on the equation for the strength of a short column derived in Galambos and Chapuis (1980), and the same reductions for slenderness as those specified for steel columns in Section E2. The design follows the same path as the design of steel columns, except that the yield stress of structural steel, the modulus of elasticity of steel, and the radius of gyration of the steel section are modified to account for the effect of concrete and longitudinal reinforcing bars. A detailed explanation of the origin of these modifications may be found in SSRC Task Group 20 (1979). Galambos and Chapuis (1980) includes comparisons of the design procedure with 48 tests of axially loaded stub columns, 96 tests of concrete-filled pipes or tubing (HSS), and 26 tests of concrete-encased steel shapes. The mean ratio of the test failure loads to the predicted strengths was 1.18 for all 170 tests, and the corresponding coefficient of variation was 0.19.

## 3. Columns with Multiple Steel Shapes

This limitation is based on Australian research reported in Bridge and Roderick (1978), which demonstrated that after hardening of the concrete the composite column will respond to loading as a unit even without lacing, tie plates, or batten plates connecting the individual steel sections.

## 4. Load Transfer

To avoid overstressing either the structural steel section or the concrete at connections, a transfer of load by direct bearing, shear connectors, or a combination of both is required. When shear connectors are used, a uniform spacing is appropriate in most situations, but when large forces are applied, other connector arrangements

may be needed to avoid overloading the component (steel section or concrete encasement) to which the load is applied directly.

Although it is recognized that force transfer also occurs by bond between the steel and concrete, this is disregarded for encased sections (Griffis, 1992). Force transfer by bond is commonly used in concrete-filled hollow structural sections (API, 1993) as long as the connections are detailed to limit local deformations, but no guidelines are available for structures other than fixed offshore platforms.

When a supporting concrete area is wider on all sides than the loaded area, the nominal bearing strength for concrete can be taken as

$$0.85\phi_B f'_c \sqrt{A_2 / A_1}$$

where  $A_1$  is the loaded area and  $A_2$  is the base of a frustum extending  $45^\circ$  in plan and at a 50 percent slope in elevation from the loaded area (ACI, 1995, 1995a). The value of  $\sqrt{A_2 / A_1}$  must be less than or equal to 2. In most practical cases, this limit will be reached and thus the Specification uses a nominal bearing strength of  $1.7\phi_B f'_c A_B$ . The resistance factor for bearing,  $\phi_B$ , is 0.65 in accordance with Appendix C in ACI 318 and ACI 318M.

### 13. FLEXURAL MEMBERS

#### 1. Effective Width

LRFD provisions for effective width omit any limit based on slab thickness, in accordance with both theoretical and experimental studies, as well as composite beam codes in other countries (ASCE, 1979). The same effective width rules apply to composite beams with a slab on either one side or both sides of the beam. To simplify design, effective width is based on the full span, center-to-center of supports, for both simple and continuous beams.

#### 2. Design Strength of Beams with Shear Connectors

This section applies to simple and continuous composite beams with shear connectors, constructed with or without temporary shores.

*Positive Flexural Design Strength.* Flexural strength of a composite beam in the positive moment region may be limited by the plastic strength of the steel section, the concrete slab, or shear connectors. In addition, web buckling may limit flexural strength if the web is slender and a significantly large portion of the web is in compression.

According to Table B5.1, local web buckling does not reduce the plastic strength of a bare steel beam if the beam depth-to-web thickness ratio is not larger than  $3.76\sqrt{E / F_y}$ . In the absence of web buckling research on composite beams, the same ratio is conservatively applied to composite beams. Furthermore, for more slender webs, the LRFD Specification conservatively adopts first yield as the flexural strength limit. In this case, stresses on the steel section from permanent loads applied to unshored beams before the concrete has hardened must be superimposed on stresses on the composite section from loads applied to the beams after hardening of concrete. In this superposition, all permanent loads should be multiplied by the dead load factor and all live loads should be multiplied by the live load factor. For shored beams, all loads may be assumed as resisted by the composite section.

When first yield is the flexural strength limit, the elastic transformed section is used to calculate stresses on the composite section. The modular ratio  $n = E / E_c$  used to determine the transformed section depends on the specified unit weight and strength of concrete. Note that this procedure for compact beams differs from the requirements of Section I2 of the 1989 AISC ASD Specification.

*Plastic Stress Distribution for Positive Moment.* When flexural strength is determined from the plastic stress distribution shown in Figure C-I3.1, the compression force  $C$  in the concrete slab is the smallest of:

$$C = A_{sw} F_{yw} + 2A_{sf} F_{yf} \quad (\text{C-I3-1})$$

$$C = 0.85 f'_c A_c \quad (\text{C-I3-2})$$

$$C = \Sigma Q_n \quad (\text{C-I3-3})$$

For a non-hybrid steel section, Equation C-I3-1 becomes  $C = A_s F_y$

where

$f'_c$  = specified compressive strength of concrete, ksi (MPa)

$A_c$  = area of concrete slab within effective width, in.<sup>2</sup> (mm<sup>2</sup>)

$A_s$  = area of steel cross section, in.<sup>2</sup> (mm<sup>2</sup>)

$A_{sw}$  = area of steel web, in.<sup>2</sup> (mm<sup>2</sup>)

$A_{sf}$  = area of steel flange, in.<sup>2</sup> (mm<sup>2</sup>)

$F_y$  = minimum specified yield stress of steel, ksi (MPa)

$F_{yw}$  = minimum specified yield stress of web steel, ksi (MPa)

$F_{yf}$  = minimum specified yield stress of flange steel, ksi (MPa)

$\Sigma Q_n$  = sum of nominal strengths of shear connectors between the point of maximum positive moment and the point of zero moment to either side, kips (N)

Longitudinal slab reinforcement makes a negligible contribution to the compression force, except when Equation C-I3-2 governs. In this case, the area of longitudinal reinforcement within the effective width of the concrete slab times the yield stress of the reinforcement may be added in determining  $C$ .

The depth of the compression block is

$$a = \frac{C}{0.85 f'_c b} \quad (\text{C-I3-4})$$

where

$b$  = effective width of concrete slab, in. (mm)

A fully composite beam corresponds to the case of  $C$  governed by the yield strength of the steel beam or the compressive strength of the concrete slab, as in Equation C-I3-1 or C-I3-2. The number and strength of shear connectors govern  $C$  for a partially composite beam as in Equation C-I3-3.

The plastic stress distribution may have the plastic neutral axis (PNA) in the web, in the top flange of the steel section or in the slab, depending on the value of  $C$ .

The nominal plastic moment resistance of a composite section in positive bending is given by the following equation and Figure C-I3.1:

$$M_n = C(d_1 + d_2) + P_y(d_3 - d_2) \quad (\text{C-I3-5})$$

where

$P_y$  = tensile strength of the steel section; for a non-hybrid steel section,  $P_y = A_s F_y$ , kips (N)

$d_1$  = distance from the centroid of the compression force  $C$  in concrete to the top of the steel section, in. (mm)

$d_2$  = distance from the centroid of the compression force in the steel section to the top of the steel section, in. (mm). For the case of no compression in the steel section  $d_2 = 0$ .

$d_3$  = distance from  $P_y$  to the top of the steel section, in. (mm)

Equation C-I3-5 is generally applicable including both non-hybrid and hybrid steel sections symmetrical about one or two axes.

*Approximate Elastic Properties of Partially Composite Beams.* Elastic calculations for stress and deflection of partially composite beams should include the effects of slip.

The effective moment of inertia  $I_{eff}$  for a partially composite beam is approximated by

$$I_{eff} = I_s + \sqrt{(\Sigma Q_n / C_f)}(I_{tr} - I_s) \quad (\text{C-I3-6})$$

where

$I_s$  = moment of inertia for the structural steel section, in.<sup>4</sup> (mm<sup>4</sup>)

$I_{tr}$  = moment of inertia for the fully composite uncracked transformed section, in.<sup>4</sup> (mm<sup>4</sup>)

$\Sigma Q_n$  = strength of shear connectors between the point of maximum positive moment and the point of zero moment to either side, kips (N)

$C_f$  = compression force in concrete slab for fully composite beam; smaller of Equations C-I3-1 and C-I3-2, kips (N)

The effective section modulus  $S_{eff}$ , referred to the tension flange of the steel section for a partially composite beam, is approximated by

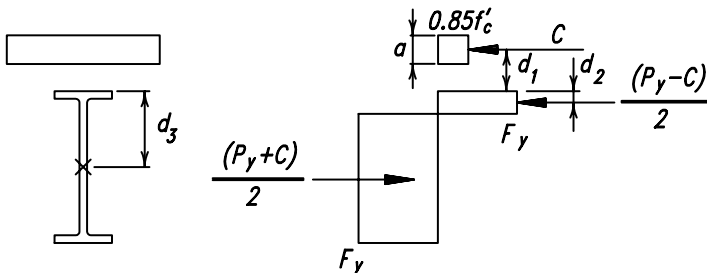

Fig. C-I3.1. Plastic stress distribution for positive moment in composite beams.

$$S_{eff} = S_s + \sqrt{(\Sigma Q_n / C_f)} (S_{tr} - S_s) \quad (\text{C-I3-7})$$

where

$S_s$  = section modulus for the structural steel section, referred to the tension flange, in.<sup>3</sup> (mm<sup>3</sup>)

$S_{tr}$  = section modulus for the fully composite uncracked transformed section, referred to the tension flange of the steel section, in.<sup>3</sup> (mm<sup>3</sup>)

Equations C-I3-6 and C-I3-7 should not be used for ratios  $\Sigma Q_n / C_f$  less than 0.25. This restriction is to prevent excessive slip, as well as substantial loss in beam stiffness. Studies indicate that Equations C-I3-6 and C-I3-7 adequately reflect the reduction in beam stiffness and strength, respectively, when fewer connectors are used than required for full composite action (Grant, Fisher, and Slutter, 1977).

It is not practical to make accurate deflection calculations of composite flexural sections in the design office. Careful comparisons to short-term deflection tests indicate that the effective moment of inertia,  $I_{eff}$ , is 15 to 30 percent lower than that calculated based on linear elastic theory. Therefore, for realistic deflection calculations,  $I_{eff}$  should be taken as 0.80  $I_{eff}$  or 0.75  $I_{eff}$ . As an alternative, it has been shown that one may use lower bound moment of inertia,  $I_{lb}$ , as defined below:

$$I_{lb} = I_x + A_s (Y_{ENA} - d_3)^2 + (\Sigma Q_n / F_y) (2d_3 + d_1 - Y_{ENA})^2 \quad (\text{C-I3-8})$$

where

$d_1$  = distance from the centroid of the longitudinal slab reinforcement to the top of the steel section, in. (mm)

$d_3$  = distance from  $P_{yc}$  to the top of the steel section, in. (mm)

$I_{lb}$  = lower bound moment of inertia, in.<sup>3</sup> (mm<sup>3</sup>)

$Y_{ENA} = [A_s d_3 + (\Sigma Q_n / F_y) (2d_3 + d_1)] / (A_s + (\Sigma Q_n / F_y))$

Calculations for long-term deformations due to creep and shrinkage may also be carried out. Because the basic properties of the concrete are not known to the designer, simplified models such as those proposed by Viest, Fountain, and Singleton (1958), Branson (1964), Chien and Ritchie (1984), and Viest, Colaco, Furlong, Griffis, Leon, and Wylie (1997) can be used.

*Negative Flexural Design Strength.* The flexural strength in the negative moment region is the strength of the steel beam alone or the plastic strength of the composite section made up of the longitudinal slab reinforcement and the steel section.

*Plastic Stress Distribution for Negative Moment.* When an adequately braced compact steel section and adequately developed longitudinal reinforcing bars act compositely in the negative moment region, the nominal flexural strength is determined from the plastic stress distributions as shown in Figure C-I3.2. The tensile force  $T$  in the reinforcing bars is the smaller of:

$$T = A_r F_{yr} \quad (\text{C-I3-9})$$

$$T = \Sigma Q_n \quad (\text{C-I3-10})$$

where

$A_r$  = area of properly developed slab reinforcement parallel to the steel beam and within the effective width of the slab, in.<sup>2</sup> (mm<sup>2</sup>)

$F_{yr}$  = specified yield stress of the slab reinforcement, ksi (MPa)

$\Sigma Q_n$  = sum of the nominal strengths of shear connectors between the point of maximum negative moment and the point of zero moment to either side, kips (N)

A third theoretical limit on  $T$  is the product of the area and yield stress of the steel section. However, this limit is redundant in view of practical limitations on slab reinforcement.

The nominal plastic moment resistance of a composite section in negative bending is given by the following equation:

$$M_n = T(d_1 + d_2) + P_{yc}(d_3 - d_2) \quad (\text{C-I3-11})$$

where

$P_{yc}$  = the compressive strength of the steel section; for a non-hybrid section  $P_{yc} = A_s F_y$ , kips (N)

$d_1$  = distance from the centroid of the longitudinal slab reinforcement to the top of the steel section, in. (mm)

$d_2$  = distance from the centroid of the tension force in the steel section to the top of the steel section, in. (mm)

$d_3$  = distance from  $P_{yc}$  to the top of the steel section, in. (mm)

*Transverse Reinforcement for the Slab.* Where experience has shown that longitudinal cracking detrimental to serviceability is likely to occur, the slab should be reinforced in the direction transverse to the supporting steel section. It is recommended that the area of such reinforcement should be at least 0.002 times the concrete area in the longitudinal direction of the beam and should be uniformly distributed.

### 3. Design Strength of Concrete-Encased Beams

Tests of concrete-encased beams demonstrated that (1) the encasement drastically reduces the possibility of lateral-torsional instability and prevents local buckling of the encased steel, (2) the restrictions imposed on the encasement practically prevent bond failure prior to first yielding of the steel section, and (3) bond failure does not necessarily limit the moment capacity of an encased steel beam (ASCE, 1979).

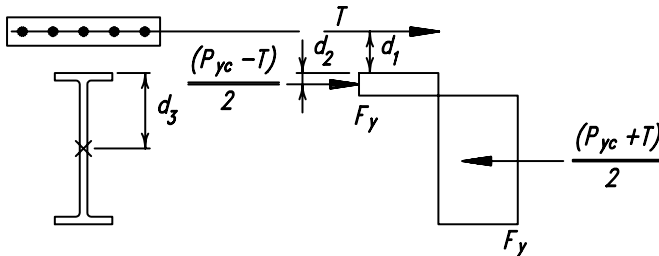

Fig. C-I3.2. Plastic stress distribution for negative moment.

Accordingly, the LRFD Specification permits three alternate design methods: one based on the first yield in the tension flange of the composite section; one based on the plastic moment capacity of the steel beam alone; and a third method based upon the plastic moment capacity of the composite section applicable only when shear connectors are provided along the steel section and reinforcement of the concrete encasement meets the specified detailing requirements. No limitations are placed on the slenderness of either the composite beam or the elements of the steel section, since the encasement effectively inhibits both local and lateral buckling.

In the method based on first yield, stresses on the steel section from permanent loads applied to unshored beams before the concrete has hardened must be superimposed on stresses on the composite section from loads applied to the beams after hardening of the concrete. In this superposition, all permanent loads should be multiplied by the dead load factor and all live loads should be multiplied by the live load factor. For shored beams, all loads may be assumed as resisted by the composite section. Complete interaction (no slip) between the concrete and steel is assumed.

The contribution of concrete to the strength of the composite section is ordinarily larger in positive moment regions than in negative moment regions. Accordingly, design based on the composite section is more advantageous in the regions of positive moments.

#### 4. Strength During Construction

When temporary shores are not used during construction, the steel beam alone must resist all loads applied before the concrete has hardened enough to provide composite action. Unshored beam deflection caused by wet concrete tends to increase slab thickness and dead load. For longer spans this may lead to instability analogous to roof ponding. An excessive increase of slab thickness may be avoided by beam camber.

When forms are not attached to the top flange, lateral bracing of the steel beam during construction may not be continuous and the unbraced length may control flexural strength, as defined in Section F1.

The LRFD Specification does not include special requirements for a margin against yield during construction. According to Section F1, maximum factored moment during construction is  $0.90F_yZ$  where  $F_yZ$  is the plastic moment ( $0.90F_yZ \approx 0.90 \times 1.1F_y S$ ). This is equivalent to approximately the yield moment,  $F_yS$ . Hence, required flexural strength during construction prevents moment in excess of the yield moment.

Load factors for construction loads should be determined for individual projects according to local conditions, using the factors stipulated in ASCE 7 as a guide. As a minimum it is suggested that 1.2 be the factor for the loading from steel framing plus concrete plus formed steel deck, and a factor of 1.6 be used for the live load of workmen plus equipment which should not be taken as less than 20 psf (unfactored).

#### 5. Formed Steel Deck

Figure C-I3.3 is a graphic presentation of the terminology used in Section I3.5.

When studs are used on beams with formed steel deck, they may be welded directly through the deck or through prepunched or cut-in-place holes in the deck. The usual

procedure is to install studs by welding directly through the deck; however, when the deck thickness is greater than 16 gage (1.5 mm) for single thickness, or 18 (1.2 mm) gage for each sheet of double thickness, or when the total thickness of galvanized coating is greater than 1.25 ounces/sq. ft (0.38 kg/m<sup>2</sup>), special precautions and procedures recommended by the stud manufacturer should be followed.

The design rules for composite construction with formed steel deck are based upon a study (Grant et al., 1977) of the then available test results. The limiting parameters listed in Section I3.5 were established to keep composite construction with formed steel deck within the available research data.

Seventeen full size composite beams with concrete slab on formed steel deck were

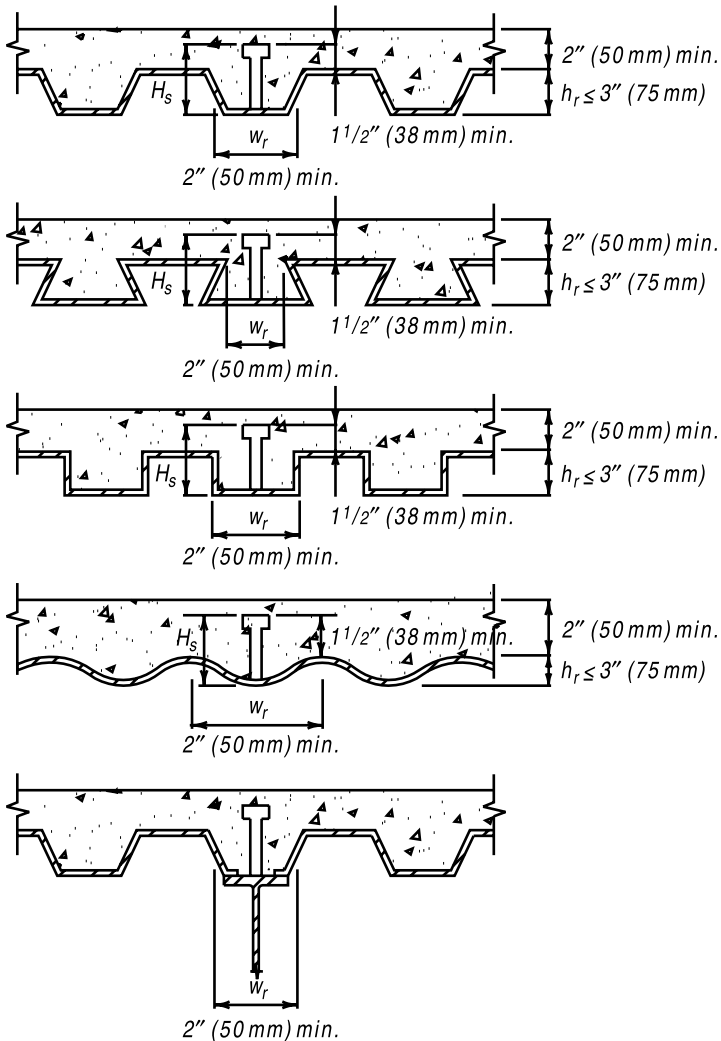

Fig. C-I3.3. Steel deck limits.



tested at Lehigh University and the results supplemented by the results of 58 tests performed elsewhere. The range of stud and steel deck dimensions encompassed by the 75 tests were limited to:

- (1) Stud dimensions:  $\frac{3}{4}$ -in. dia.  $\times$  3.00 to 7.00 in.
- (2) Rib width: 1.94 in. to 7.25 in.
- (3) Rib height: 0.88 in. to 3.00 in.
- (4) Ratio  $w_r/h_r$ : 1.30 to 3.33
- (5) Ratio  $H_s/h_r$ : 1.50 to 3.41
- (6) Number of studs in any one rib: 1, 2, or 3

The strength of stud connectors installed in the ribs of concrete slabs on formed steel deck with the ribs oriented perpendicular to the steel beam is reasonably estimated by the strength of stud connectors in flat soffit composite slabs multiplied by values computed from Equation I3-1.

The 1999 edition of the Specification includes a new upper limit of 0.75 on the reduction factor of Equation I3-1 for single studs located in deck ribs oriented perpendicular to the beam. This limit has been imposed as a temporary measure in response to a mounting set of test data (e.g., Easterling, Gibbings, and Murray, 1993; Kemp and Trincherro, 1997) that indicates that stud strengths calculated by the product of Equations I3-1 and I5-1 may be unconservative when a single stud per rib is used. Research to further resolve this issue and to assess whether stud pairs are also affected is currently underway. Differences between recent test results and those originally used to develop Equation I5-1 for ribbed decks (Grant et al., 1977) appear to be due to the fact that (1) most of the earlier tests reported by Grant et al. were for beams with studs placed in pairs centered within the ribs, (2) stud strengths used to originally calibrate Equation I5-1 were back calculated from moment strengths of beam specimens which tend to mask variations in the stud strengths, and (3) differences in modern steel deck profiles that affect the placement of studs in the rib. The last reason may be particularly important. As shown in Figure C-I3.4, modern steel deck profiles with stiffeners (reinforcing rib) located along the center line of the rib require that studs be placed off-center in the rib. Depending on the location of the stud relative to the direction of shear transfer, for studs in the “weak position”, the resulting reduction in edge distance between the stud and rib wall can lead to premature failure accompanied by punching of the stud through the steel deck. Therefore, in addition to applying the required cap of 0.75 on the reduction factor (Equation I3-1) for single studs in a rib, it is recommended to avoid situations where all the studs may be located in the “weak position” by either alternating stud placement between the “weak” and “strong” positions or coordinating placement of studs to ensure they are all installed in the strong position.

For the case where ribs run parallel to the beam, limited testing (Grant et al., 1977) has shown that shear connection is not significantly affected by the ribs. However, for narrow ribs, where the ratio  $w_r/h_r$  is less than 1.5, a shear stud reduction factor, Equation I3-2, has been employed in view of lack of test data.

The Lehigh study (Grant et al., 1977) also indicated that Equation C-I3-7 for effective section modulus and Equation C-I3-6 for effective moment of inertia were valid for composite construction with formed steel deck.

Based on the Lehigh test data (Grant et al., 1977), the maximum spacing of steel deck anchorage to resist uplift was increased from 16 (405 mm) to 18 in. (460 mm) in order to accommodate current production profiles.

When metal deck includes units for carrying electrical wiring, crossover headers are commonly installed over the cellular deck perpendicular to the ribs. They create trenches which completely or partially replace sections of the concrete slab above the deck. These trenches, running parallel to or transverse to a composite beam, may reduce the effectiveness of the concrete flange. Without special provisions to replace the concrete displaced by the trench, the trench should be considered as a complete structural discontinuity in the concrete flange.

When trenches are parallel to the composite beam, the effective flange width should be determined from the known position of the trench.

Trenches oriented transverse to composite beams should, if possible, be located in areas of low bending moment and the full required number of studs should be placed between the trench and the point of maximum positive moment. Where the trench cannot be located in an area of low moment, the beam should be designed as non-composite.

## 6. Design Shear Strength

A conservative approach to vertical shear provisions for composite beams is adopted by assigning all shear to the steel section web. This neglects any concrete slab contribution and serves to simplify the design.

## 14. COMBINED COMPRESSION AND FLEXURE

The procedure adopted for the design of beam-columns is described and supported by comparisons with test data in Galambos and Chapuis (1980). The basic approach is identical to that specified for steel columns in Section H1.

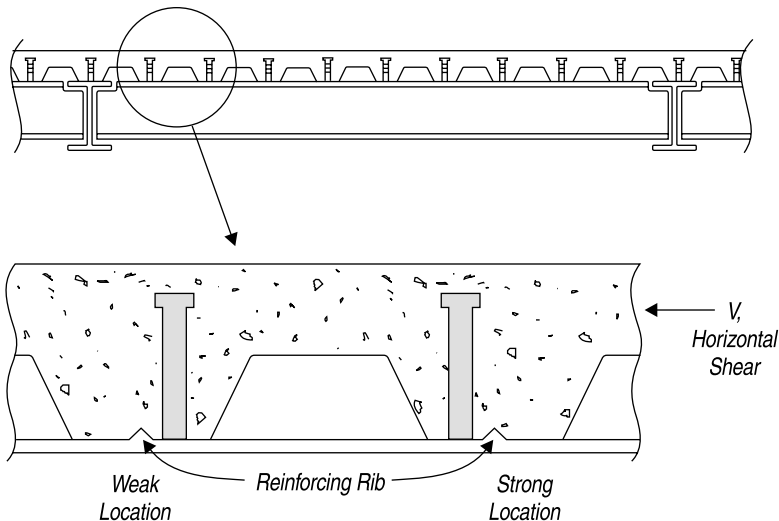

Fig. C-13.4. Alternative shear stud positions in rib decked profiles.

The nominal axial strength of a beam-column is obtained from Section I2.2, while the nominal flexural strength is determined from the plastic stress distribution on the composite section. An approximate formula for this plastic moment resistance of a composite column is given in Galambos and Chapuis (1980).

$$M_n = M_p = ZF_y + \frac{(h_2 - 2c_r)}{3} A_r F_{yr} + \left( \frac{h_2}{2} - \frac{A_w F_y}{1.7 f'_c h_1} \right) A_w F_y \quad (\text{C-I4-1})$$

where

- $A_w$  = web area of encased steel shape; for concrete-filled HSS,  $A_w = 0$ , in.<sup>2</sup> (mm<sup>2</sup>)
- $Z$  = plastic section modulus of the steel section, in.<sup>3</sup> (mm<sup>3</sup>)
- $c_r$  = average of distance from compression face to longitudinal reinforcement in that face and distance from tension face to longitudinal reinforcement in that face, in. (mm)
- $h_1$  = width of composite cross section perpendicular to the plane of bending, in. (mm)
- $h_2$  = width of composite cross section parallel to the plane of bending, in. (mm)

The supporting comparisons with beam-column tests included 48 concrete filled pipes or tubing and 44 concrete-encased steel shapes (Galambos and Chapuis, 1980). The overall mean test-to-prediction ratio was 1.23 and the coefficient of variation 0.21.

The last paragraph in Section I4 provides a transition from beam-columns to beams. It involves bond between the steel section and concrete. Section I3 for beams requires either shear connectors or full, properly reinforced encasement of the steel section. Furthermore, even with full encasement, it is assumed that bond is capable of developing only the moment at first yielding in the steel of the composite section. No test data are available on the loss of bond in composite beam-columns. However, consideration of tensile cracking of concrete suggests  $P_u / \phi_c P_n = 0.3$  as a conservative limit. It is assumed that when  $P_u / \phi_c P_n$  is less than 0.3, the nominal flexural strength is reduced below that indicated by plastic stress distribution on the composite cross section unless the transfer of shear from the concrete to the steel is provided for by shear connectors.

## 15. SHEAR CONNECTORS

### 1. Materials

Tests (Ollgaard, Slutter, and Fisher, 1971) have shown that fully composite beams with concrete meeting the requirements of Part 3, Chapter 4, "Concrete Quality," of ACI (1999), made with ASTM C33 or rotary-kiln produced C330 aggregates, develop full flexural capacity.

### 2. Horizontal Shear Force

Composite beams in which the longitudinal spacing of shear connectors was varied according to the intensity of the static shear, and duplicate beams in which the connectors were uniformly spaced, exhibited the same ultimate strength and the same amount of deflection at normal working loads. Only a slight deformation in the concrete and the more heavily stressed connectors is needed to redistribute the horizon-

tal shear to other less heavily stressed connectors. The important consideration is that the total number of connectors be sufficient to develop the shear  $V_h$  on either side of the point of maximum moment. The provisions of the LRFD Specification are based upon this concept of composite action.

In computing the design flexural strength at points of maximum negative bending, reinforcement parallel to the steel beam within the effective width of the slab may be included, provided such reinforcement is properly anchored beyond the region of negative moment. However, enough shear connectors are required to transfer the ultimate tensile force in the reinforcement, from the slab to the steel beam.

### 3. Strength of Stud Shear Connectors

Studies have defined stud shear connector strength in terms of normal weight and lightweight aggregate concretes as a function of both concrete modulus of elasticity and concrete strength as given by Equation I5-1.

Equation I5-1, obtained from Ollgaard et al. (1971), corresponds to Tables I4.1 and I4.2 in Section I4 of the 1989 AISC ASD Specification. Note that an upper bound on stud shear strength is the product of the cross-sectional area of the stud times its ultimate tensile strength.

The LRFD Specification does not specify a resistance factor for shear connector strength. The resistance factor for the flexural strength of a composite beam accounts for all sources of variability, including those associated with the shear connectors.

### 4. Strength of Channel Shear Connectors

Equation I5-2 is a modified form of the formula for the strength of channel connectors developed by Slutter and Driscoll (1965). The modification has extended its use to lightweight concrete.

### 6. Shear Connector Placement and Spacing

Uniform spacing of shear connectors is permitted except in the presence of heavy concentrated loads.

Studs not located directly over the web of a beam tend to tear out of a thin flange before attaining full shear-resisting capacity. To guard against this contingency, the size of a stud not located over the beam web is limited to  $2\frac{1}{2}$  times the flange thickness (Goble, 1968).

The minimum spacing of connectors along the length of the beam, in both flat soffit concrete slabs and in formed steel deck with ribs parallel to the beam, is six diameters; this spacing reflects development of shear planes in the concrete slab (Ollgaard et al., 1971). Since most test data are based on the minimum transverse spacing of four diameters, this transverse spacing was set as the minimum permitted. If the steel beam flange is narrow, this spacing requirement may be achieved by staggering the studs with a minimum transverse spacing of three diameters between the staggered row of studs. The reduction in connector capacity in the ribs of formed steel decks is provided by the factor  $0.85 / \sqrt{N_r}$ , which accounts for the reduced capacity of multiple connectors, including the effect of spacing. When deck ribs are parallel to the beam and the design requires more studs than can be

placed in the rib, the deck may be split so that adequate spacing is available for stud installation. Figure C-15.1 shows possible connector arrangements.

## 16. SPECIAL CASES

Tests are required for construction that falls outside the limits given in the Specification. Different types of shear connectors may require different spacing and other detailing than stud and channel connectors.

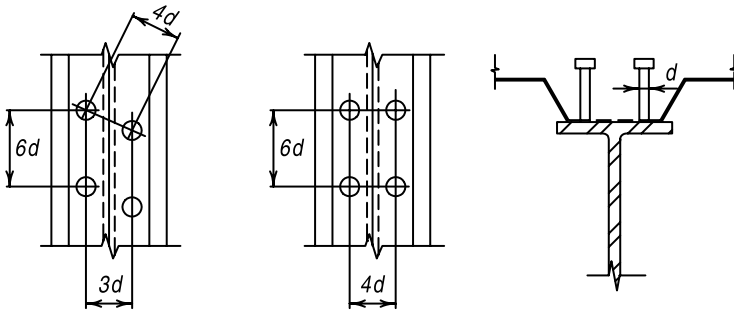

Fig. C-15.1. Shear connector arrangements.

## CHAPTER J

### CONNECTIONS, JOINTS, AND FASTENERS

#### J1. GENERAL PROVISIONS

##### 5. Splices in Heavy Sections

Solidified but still-hot filler metal contracts significantly as it cools to ambient temperature. Shrinkage of large welds between elements which are not free to move to accommodate the shrinkage causes strains in the material adjacent to the weld that can exceed the yield point strain. In thick material the weld shrinkage is restrained in the thickness direction, as well as in the width and length directions, causing triaxial stresses to develop that may inhibit the ability of ductile steel to deform in a ductile manner. Under these conditions, the possibility of brittle fracture increases.

When splicing ASTM A6/A6M Group 4 and 5 rolled sections or heavy welded built-up members, the potentially harmful weld shrinkage strains can be avoided by using bolted splices or fillet-welded lap splices or splices that combine a welded and bolted detail (see Figure C-J1.1). Details and techniques that perform well for materials of modest thickness usually must be changed or supplemented by more demanding requirements when welding thick material. Also, the provisions of the *Structural Welding Code*, AWS D1.1, are minimum requirements that apply to most structural welding situations; however, when designing and fabricating welded splices of ASTM A6/A6M Group 4 and 5 shapes and similar built-up cross sections, special consideration must be given to all aspects of the welded splice detail.

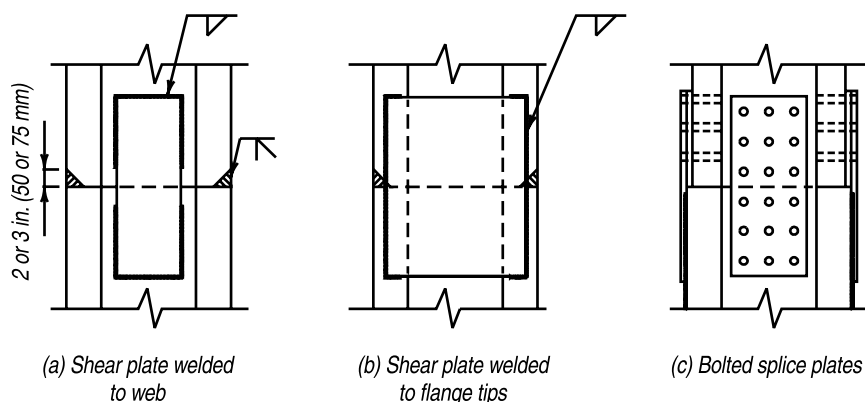
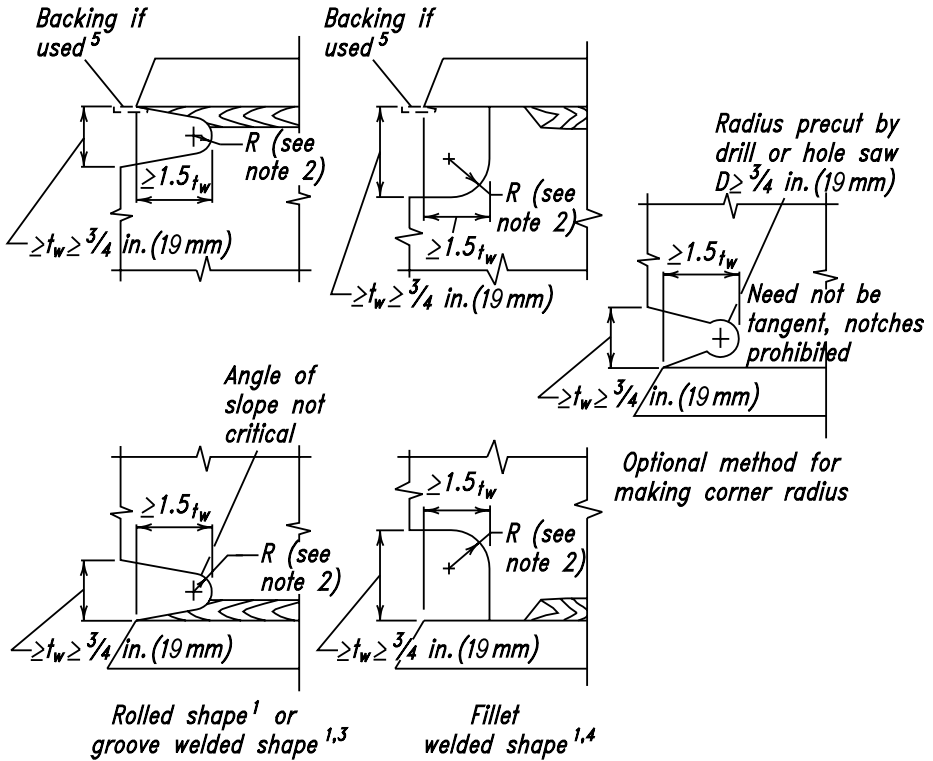

Fig. C-J1.1. Alternative splices that minimize weld restraint tensile stresses.

- Notch-toughness requirements should be specified for tension members. See Commentary Section A3.
- Generously sized weld access holes, Figure C-J1.2, are required to provide increased relief from concentrated weld shrinkage strains, to avoid close juncture of welds in orthogonal directions, and to provide adequate clearance for the exercise of high quality workmanship in hole preparation, welding, and ease of inspection.



Notes:

1. For ASTM A6 Group 4 and 5 shapes and welded built-up shapes with plate thickness more than 2 in. (50 mm), preheat to 150°F (65° C) prior to thermal cutting, grind and inspect thermally cut edges of access hole using magnetic particle or dye penetration methods prior to making web and flange splice groove welds.
2. Radius shall provide smooth notch-free transition;  $R \geq \frac{3}{8}$ -in. (10 mm) (typical  $\frac{1}{2}$ -in. (13 mm))
3. Access opening made after welding web to flange.
4. Access opening made before welding web to flange.
5. These are typical details for joints welded from one side against steel backing. Alternative joint designs should be considered.

Fig. C-J1.2. Weld access hole geometry.

- Preheating for thermal cutting is required to minimize the formation of a hard surface layer.
- Grinding to bright metal and inspection using magnetic particle or dye-penetrant methods is required to remove the hard surface layer and to assure smooth transitions free of notches or cracks.

In addition to tension splices of truss chord members and tension flanges of flexural members, other joints fabricated of heavy sections subject to tension should be given special consideration during design and fabrication.

## 8. Placement of Welds and Bolts

Slight eccentricities between the gravity axis of single and double angle members and the center of gravity of connecting rivets or bolts have long been ignored as having negligible effect on the static strength of such members. Tests (Gibson and Wake, 1942) have shown that similar practice is warranted in the case of welded members in statically loaded structures.

However, the fatigue life of eccentrically loaded welded angles has been shown to be very short (Kloppel and Seeger, 1964). Notches at the roots of fillet welds are harmful when alternating tensile stresses are normal to the axis of the weld, as could occur due to bending when axial cyclic loading is applied to angles with end welds not balanced about the neutral axis. Accordingly, balanced welds are indicated when such members are subjected to cyclic loading (see Figure C-J1.3).

## 9. Bolts in Combination with Welds

Welds will not share the load equally with mechanical fasteners in bearing-type connections. Before ultimate loading occurs, the fastener will slip and the weld will carry an indeterminately larger share of the load.

Accordingly, the sharing of load between welds and A307 bolts or high-strength bolts in a bearing-type connection is not recommended. For similar reasons, A307 bolts and rivets should not be assumed to share loads in a single group of fasteners.

For high-strength bolts in slip-critical connections to share the load with welds it is

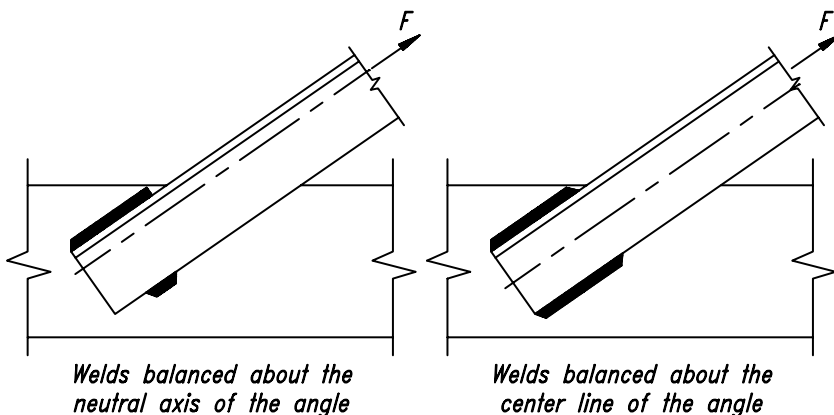

Figure C-J1.3. Balanced welds.



advisable to fully tension the bolts before the weld is made. If the weld is placed first, angular distortion from the heat of the weld might prevent the faying action required for development of the slip-critical force. When the bolts are fully tensioned before the weld is made, the slip-critical bolts and the weld may be assumed to share the load on a common shear plane (Kulak, Fisher, and Struik, 1987). The heat of welding near bolts will not alter the mechanical properties of the bolts.

In making alterations to existing structures, it is assumed that whatever slip is likely to occur in high-strength bolted bearing-type connections or riveted connections will have already taken place. Hence, in such cases the use of welding to resist all stresses, other than those produced by existing dead load present at the time of making the alteration, is permitted.

It should be noted that combinations of fasteners as defined herein does not refer to connections such as shear plates for beam-to-column connections which are welded to the column and bolted to the beam flange or web (Kulak et al., 1987) and other comparable connections.

## **10. High-Strength Bolts in Combination with Rivets**

When high-strength bolts are used in combination with rivets, the ductility of the rivets permits the direct addition of the strengths of both fastener types.

## **J2. WELDS**

### **1. Groove Welds**

The engineer preparing contract design drawings cannot specify the depth of groove without knowing the welding process and the position of welding. Accordingly, only the effective throat for partial-joint-penetration groove welds should be specified on design drawings, allowing the fabricator to produce this effective throat with his own choice of welding process and position. The weld reinforcement is not used in determining the effective throat thickness of a groove weld (see Table J2.1).

### **2. Fillet Welds**

#### **2a. Effective Area**

The effective throat of a fillet weld is based upon the root of the joint and the face of the diagrammatic weld, hence this definition gives no credit for weld penetration or reinforcement at the weld face. If the fillet weld is made by the submerged arc welding process, some credit for penetration is made. If the leg size of the resulting fillet weld exceeds  $\frac{3}{8}$ -in. (10 mm), then 0.11 in. (3 mm) is added to the theoretical throat. This increased weld throat is allowed because the submerged arc process produces deep penetration of welds of consistent quality. However, it is necessary to run a short length of fillet weld to be assured that this increased penetration is obtained. In practice, this is usually done initially by cross-sectioning the runoff plates of the joint. Once this is done, no further testing is required, as long as the welding procedure is not changed.

## 2b. Limitations

Table J2.4 provides a minimum size of fillet weld for a given thickness of the thicker part joined.

The requirements are not based upon strength considerations, but upon the quench effect of thick material on small welds. Very rapid cooling of weld metal may result in a loss of ductility. Further, the restraint to weld metal shrinkage provided by thick material may result in weld cracking. Because a  $\frac{5}{16}$ -in. (8 mm) fillet weld is the largest that can be deposited in a single pass by SMAW process,  $\frac{5}{16}$ -in. (8 mm) applies to all material  $\frac{3}{4}$ -in. (19 mm) and greater in thickness, but minimum preheat and interpass temperature are required by AWS D1.1.\* Both the design engineer and the shop welder must be governed by the requirements.

Table J2.3 gives the minimum effective throat of a partial-joint-penetration groove weld. Notice that Table J2.3 for partial-joint-penetration groove welds goes up to a plate thickness of over 6 in. (150 mm) and a minimum weld throat of  $\frac{5}{8}$ -in. (16 mm), whereas, for fillet welds Table J2.4 goes up to a plate thickness of over  $\frac{3}{4}$ -in. (19 mm) and a minimum leg size of fillet weld of only  $\frac{5}{16}$ -in. (8 mm). The additional thickness for partial-joint-penetration groove welds is to provide for reasonable proportionality between weld and material thickness.

For plates of  $\frac{1}{4}$ -in. (6 mm) or more in thickness, it is necessary that the inspector be able to identify the edge of the plate to position the weld gage. This is assured if the weld is kept back at least  $\frac{1}{16}$ -in. (2 mm) from the edge, as shown in Figure C-J2.1.

Where longitudinal fillet welds are used alone in a connection (see Figure C-J2.2), Section J2.2b requires the length of each weld to be at least equal to the width of the connecting material because of shear lag (Freeman, 1930).

By providing a minimum lap of five times the thickness of the thinner part of a lap

\* See Table J2.4.

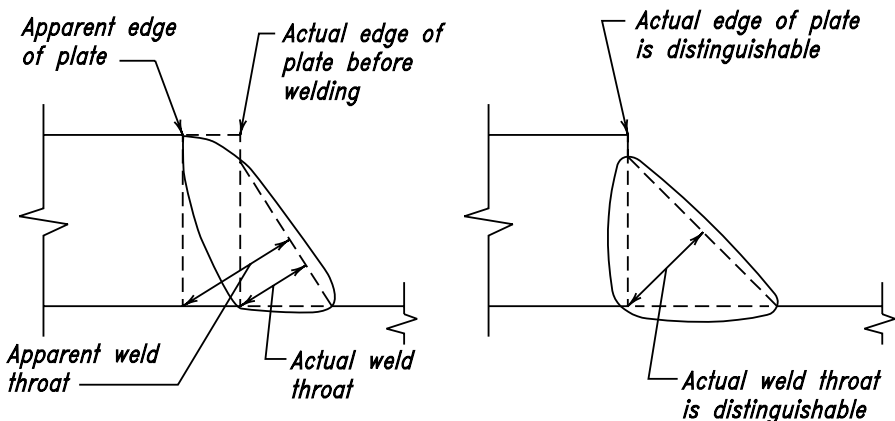

Fig. C-J2.1. Identification of plate edge.

joint, the resulting rotation of the joint when pulled will not be excessive, as shown in Figure C-J2.3. Fillet welded lap joints under tension tend to open and apply a tearing action at the root of the weld as shown in Figure C-J2.4b, unless restrained by a force  $F$  as shown in Figure C-J2.4a.

End returns are not essential for developing the capacity of fillet welded connections and have a negligible effect on their strength. Their use has been encouraged to insure that the weld size is maintained over the length of the weld, to enhance the fatigue resistance of cyclically loaded flexible end connections, and to increase the plastic deformation capability of such connections.

The weld capacity database on which the specifications were developed had no end returns. This includes the study by Higgins and Preece (1968), seat angle tests by Lyse and Schreiner (1935), the seat and top angle tests by Lyse and Gibson (1937), beam webs welded directly to column or girder by fillet welds by Johnston and Deits (1942), and the eccentrically loaded welded connections reported by Butler, Pal, and Kulak (1972). Hence, the current design-resistance values and joint-capacity models do not require end returns when the required weld size is provided. Johnston and Green (1940) noted that movement consistent with the design assumption of no end restraint (i.e., joint flexibility) was enhanced without end returns. They also verified that greater plastic deformation of the connection was achieved when end returns existed, although the strength was not significantly different.

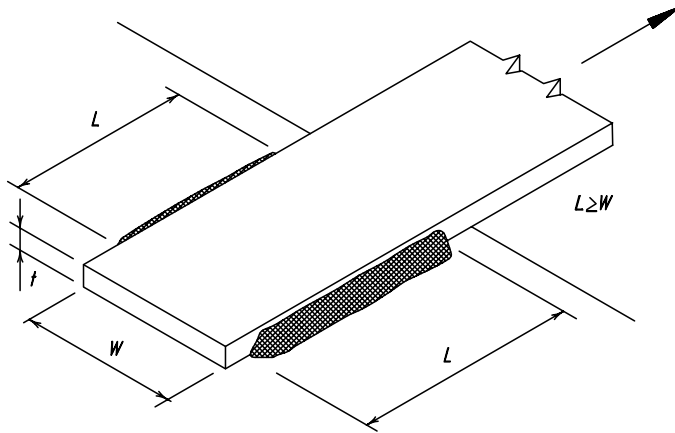

Fig. C-J2.2. Longitudinal fillet welds.

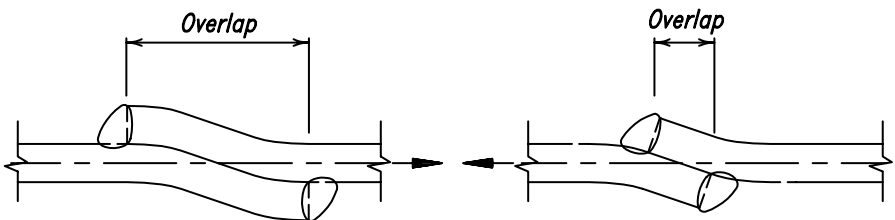

Fig. C-J2.3. Minimum lap.

When longitudinal fillet welds parallel to the stress are used to transmit the load to the end of an axially loaded member, the welds are termed “end loaded”. Typical examples of such welds would include, but are not necessarily limited to, longitudinally welded lap joints at the end of axially loaded members, welds attaching bearing stiffeners, and similar cases. Typical examples of longitudinally loaded fillet welds which are not considered end loaded include, but are not limited to, welds that connect plates or shapes to form built-up cross sections in which the shear force is applied to each increment of length of weld stress depending upon the distribution of shear load along the length of the member, welds attaching beam web connection angles and shear plates because the flow of shear force from the beam or girder web to the weld is essentially uniform throughout the weld length, that is, the weld is not end-loaded despite the fact that it is loaded parallel to the weld axis. Neither does the reduction factor apply to welds attaching stiffeners to webs because the stiffeners and welds are not subject to calculated axial stress but merely serve to keep the web flat.

The distribution of stress along the length of end loaded fillet welds is far from uniform and is dependent upon complex relationships between the stiffness of the longitudinal fillet weld relative to the stiffness of the connected materials. Beyond some length, it is non-conservative to assume that the average stress over the total length of the weld may be taken as equal to the full design strength. Experience has shown that when the length of the weld is equal to approximately 100 times the weld size or less, it is reasonable to assume the effective length is equal to the actual length. For weld lengths greater than 100 times the weld size, the effective length should be taken less than the actual length. The reduction coefficient,  $\beta$ , provided in Section J2.2b is the equivalent of Eurocode 3, which is a simplified approximation to exponential formulas developed by finite element studies and tests performed in Europe over many years. The criterion is based upon combined consideration of nominal strength for fillet welds with leg size less than  $\frac{1}{4}$  in. (6 mm) and upon a judgement based serviceability limit of slightly less than  $\frac{1}{32}$  in. (1 mm) displacement at the end of the weld for welds with leg size  $\frac{1}{4}$  in. (6 mm) and larger. Mathematically, the application of the  $\beta$  factor implies that the minimum strength of an end-loaded weld is achieved when the length is approximately 300 times the leg size. Because it is illogical to conclude that the total strength of a weld longer than 300 times the weld size would be less than a shorter weld, the length reduction coefficient is taken as 0.6 when the weld length is greater than 300 times the leg size.

*Fillet weld terminations* do not affect the strength or serviceability of connections

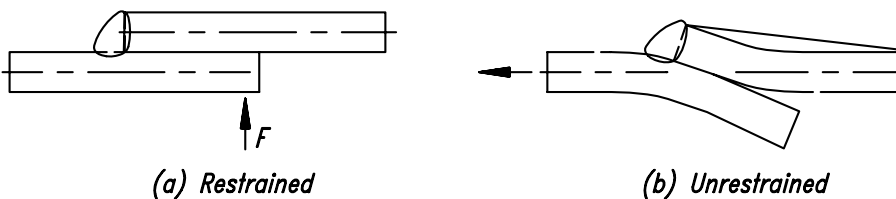

Fig. C-J2.4. Restraint of lap joints.

in most cases. However, in certain cases, the disposition of welds affect the planned function of connections, and notches may affect the static strength and/or the resistance to crack initiation if cyclic loads of sufficient magnitude and frequency occur. For these cases, limitations are specified to assure desired performance.

- (a) At lapped joints where one part extends beyond the end or edge of the part to which it is welded and if the parts are subject to calculated tensile stress at the start of the overlap, it is important that the weld terminate a short distance from the stressed edge. For one typical example, the lap joint between the tee chord and the web members of a truss, the weld should not extend to the edge of the tee stem. See Figure C-J2.5. The best technique to avoid inadvertent notches at this critical location is to strike the welding arc at a point slightly back from the edge and proceed with welding in the direction away from the edge. See Figure C-J2.6. On the other hand, where framing angles extend beyond the end of the beam web to which they are welded, the free end of the beam web is subject to zero stress; thus, it is permissible for the fillet weld to extend continuously across the top end, along the side and along the bottom end of the angle to the extreme end of the beam. See Figure C-J2.7.
- (b) For connections which are subject to maximum stress at the weld termination

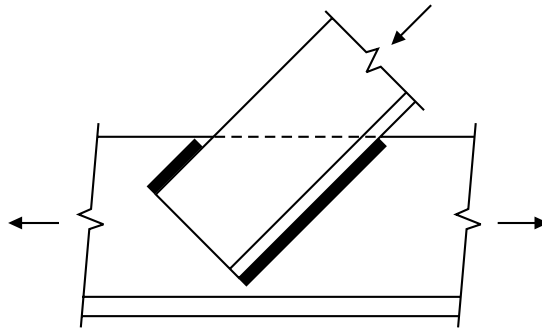

Fig. C-J2.5. Fillet welds near tension edges.

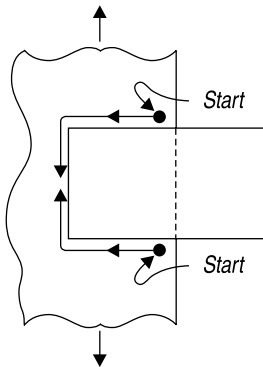

Fig. C-J2.6. Suggested direction of welding travel to avoid notches.

due to cyclic forces and/or moments of sufficient magnitude and frequency to initiate cracks emanating from unfilled start or stop craters or other discontinuities, at the end of the weld must be protected by boxing or returns. If the bracket is a plate projecting from the face of a support, extra care must be exercised in the deposition of the boxing weld across the thickness of the plate to assure that a fillet free of notches is provided.

- (c) For connections such as framing angles and simple end plates which are assumed in design of the structure to be flexible connections, the top and bottom edges of the outstanding legs must be left unwelded over a substantial portion of their length in order to assure flexibility of the connection. Research tests (Johnston and Green, 1940) have shown that the static strength of the connection is the same with or without end returns; therefore the use of returns is optional, but if used, their length must be restricted to not more than four times the weld size, see Figure C-J2.8.
- (d) Experience has shown that when ends of intermediate transverse stiffeners on the webs of plate girders are not welded to the flanges (the usual practice), small torsional distortions of the flange which occur near shipping bearing points in the normal course of shipping by rail or truck may cause high out-of-plane bending stresses (yield point) and fatigue cracking at the toe of the web-to-flange welds. This has been observed even with closely fitted stiff-

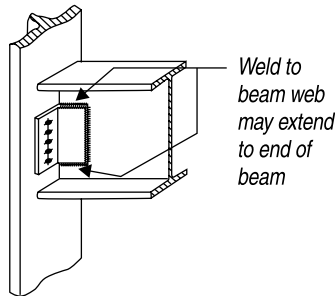

Fig.C-J2.7. Fillet weld details on framing angles.

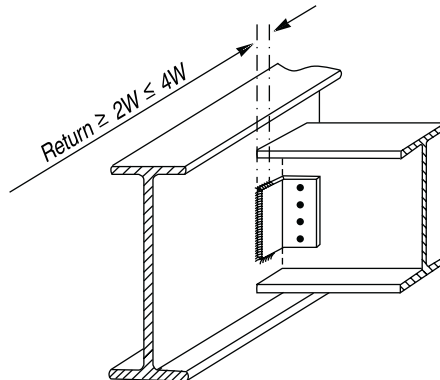

Fig.C-J2.8. Flexible connection returns optional unless subject to fatigue.

eners. The intensity of these out-of-plane stresses may be effectively limited and cracking prevented if “breathing room” is provided by terminating web-to-flange welds. The unwelded distance should not exceed six times the web thickness to assure that column buckling of the web within the unwelded length does not occur.

- (e) For fillet welds which occur on opposite sides of a common plane, it is not possible to deposit a weld continuously around the corner from one side to the other without causing a gouge in the corner of the parts joined; therefore the welds must be interrupted at the corner. See Figure C-J2.9.

**4. Design Strength**

The strength of welds is governed by the strength of either the base material or the deposited weld metal. Table J2.5 contains the resistance factors and nominal weld strengths, as well as a number of limitations.

It should be noted that in Table J2.5 the nominal strength of fillet welds is determined from the effective throat area, whereas the strength of the connected parts is governed by their respective thicknesses. Figure C-J2.10 illustrates the shear planes for fillet welds and base material:

- (a) Plane 1-1, in which the resistance is governed by the shear strength for material A.

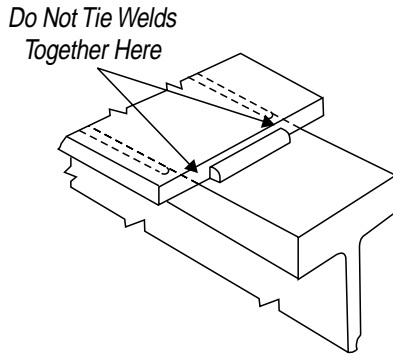

Fig. C-J2.9. Details for fillet welds which occur on opposite sides of a common plane.

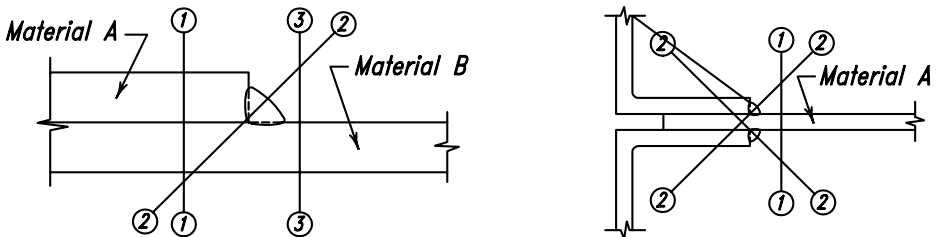

Fig. C-J2.10. Shear planes for fillet welds loaded in longitudinal shear.

- (b) Plane 2-2, in which the resistance is governed by the shear strength of the weld metal.
- (c) Plane 3-3, in which the resistance is governed by the shear strength of the material B.

The resistance of the welded joint is the lowest of the resistance calculated in each plane of shear transfer. Note that planes 1-1 and 3-3 are positioned away from the fusion areas between the weld and the base material. Tests have demonstrated that the stress on this fusion area is not critical in determining the shear strength of fillet welds (Preece, 1968).

The shear planes for plug and partial-joint-penetration groove welds are shown in Figure C-J2.11 for the weld and base metal. Generally the base metal will govern the shear strength.

## 5. Combination of Welds

This method of adding weld strengths does not apply to a welded joint using a partial-joint-penetration single bevel groove weld with a superimposed fillet weld. In this case, the effective throat of the combined joint must be determined and the design strength based upon this throat area.

## 6. Weld Metal Requirements

Applied and residual stresses and geometrical discontinuities from back-up bars with associated notch effects contribute to sensitivity to fracture. Some weld metals in combination with certain procedures result in welds with low notch toughness. The Specification requires a minimum specified toughness for weld metals in those joints that are subject to more significant applied stresses and toughness demands.

The level of toughness required was selected as one level more conservative than

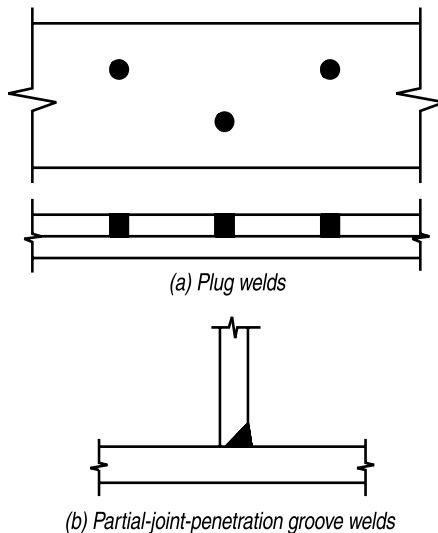

Fig. C-J2.11. Shear planes for plug and partial-joint-penetration groove welds.



the base metal requirement for Group 4 and 5 shapes. Research continues on this subject.

**7. Mixed Weld Metal**

Problems can occur when incompatible weld metals are used in combination and notch-tough composite weld metal is required. For instance, tack welds deposited using a self-shielded process with aluminum deoxidizers in the electrodes and subsequently covered by SAW weld passes can result in composite weld metal with low notch-toughness, despite the fact that each process by itself could provide notch-tough weld metal.

**J3. BOLTS AND THREADED PARTS**

**1. High-Strength Bolts**

In general, the use of high-strength bolts is required to conform to the provisions of the *Load and Resistance Factor Design Specification for Structural Joints Using ASTM A325 or A490 Bolts* (RCSC, 1994) as approved by the Research Council on Structural Connections.

Occasionally the need arises for the use of high-strength bolts of diameters and lengths in excess of those available for A325 or A325M and A490 or A490M bolts, as for example, anchor rods for fastening machine bases. For this situation Section A3.3 permits the use of A449 bolts and A354 threaded rods.

With this edition of the Specification snug-tightened installation is permitted for static applications involving ASTM A325 or A325M bolts (only) in tension or combined shear and tension. Figures C-J3.1 and C-J3.2 illustrate the results of testing by Johnson (1996) on tee stubs bolted flange-to-flange with two ASTM A325 bolts. This testing involved two lengths ( $2\frac{3}{4}$  in. and  $3\frac{1}{4}$  in.) (70 mm and 83 mm) and several combinations of installed pretension (finger-tight, snug-tight, and pretensioned). The  $2\frac{3}{4}$ -in. (70 mm) bolt length corresponds to the least number of threads remaining in the grip. The  $3\frac{1}{4}$ -in. (83 mm) bolt length corresponds to the maximum number of threads remaining in the grip. As evidenced by the data, the installation condition does not affect the ultimate strength.

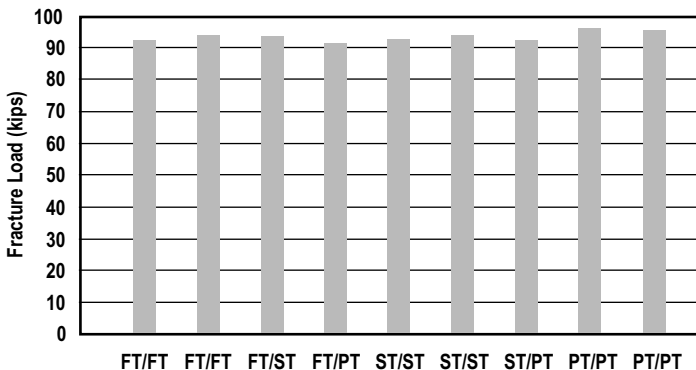

Fig. C-J3.1. Johnson (1996) tests,  $2\frac{3}{4}$ -in.-long,  $\frac{3}{4}$ -in.-diameter ASTM A325 bolts.

There are practical cases in the design of structures where slip of the connection is desirable in order to allow for expansion and contraction of a joint in a controlled manner. Regardless of whether force transfer is required in the directions normal to the slip direction, the nuts should be hand-tightened with a spud wrench and then backed off one-quarter turn. Furthermore, it is advisable to deform the bolt threads or use a locking nut or jamb nut to insure that the nut does not back off under service conditions. Thread deformation is commonly accomplished with a cold chisel and hammer applied at one location. Note that tack-welding of the nut to the bolt threads is discouraged.

## 2. Size and Use of Holes

To provide some latitude for adjustment in plumbing up a frame during erection, three types of enlarged holes are permitted, subject to the approval of the designer. The nominal maximum sizes of these holes are given in Table J3.3 or J3.3M. The use of these enlarged holes is restricted to connections assembled with bolts and is subject to the provisions of Sections J3.3 and J3.4.

## 3. Minimum Spacing

The *maximum* factored strength  $R_n$  at a bolt or rivet hole in bearing requires that the distance between the centerline of the first fastener and the edge of a plate toward which the force is directed should not be less than  $1\frac{1}{2}d$  where  $d$  is the fastener diameter (Kulak et al., 1987). By similar reasoning the distance measured in the line of force, from the centerline of any fastener to the nearest edge of an adjacent hole, should not be less than  $3d$ , to ensure maximum design strength in bearing. Plotting of numerous test results indicates that the critical bearing strength is directly proportional to the above defined distances up to a maximum value of  $3d$ , above which no additional bearing strength is achieved (Kulak et al., 1987). Table J3.7 lists the increments that must be added to adjust the spacing upward to compensate for an increase in hole dimension parallel to the line of force. Section J3.10 gives the bearing strength criteria as a function of spacing.

## 4. Minimum Edge Distance

Critical bearing stress is a function of the material tensile strength, the spacing of

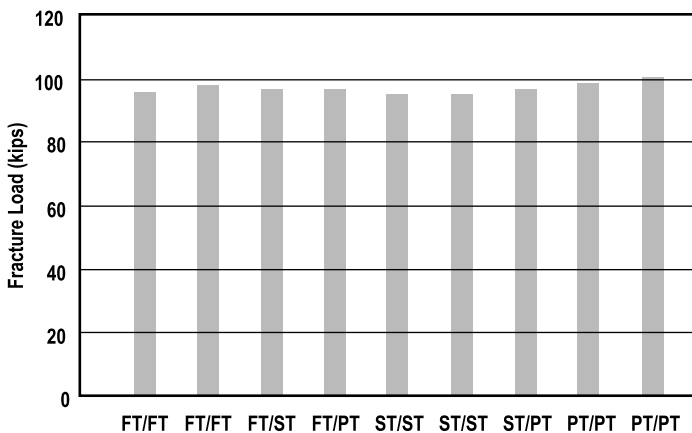

Fig. C-J3.2. Johnson (1996) tests,  $3\frac{1}{4}$ -in.-long,  $\frac{3}{4}$ -in.-diameter ASTM A325 bolts.

fasteners, and the distance from the edge of the part to the center line of the nearest fastener. Tests have shown (Kulak et al., 1987) that a linear relationship exists between the ratio of critical bearing stress to tensile strength (of the connected material) and the ratio of fastener spacing (in the line of force) to fastener diameter. The following equation affords a good lower bound to published test data for single-fastener connections with standard holes, and is conservative for adequately spaced multi-fastener connections:

$$\frac{F_{pcr}}{F_u} = \frac{l_e}{d} \quad (\text{C-J3-1})$$

where

$F_{pcr}$  = critical bearing stress, ksi (MPa)

$F_u$  = tensile strength of the connected material, ksi (MPa)

$l_e$  = distance, along a line of transmitted force, from the center of a fastener to the nearest edge of an adjacent fastener or to the free edge of a connected part (in the direction of stress), in. (mm)

$d$  = diameter of fastener, in. (mm)

The provisions of Section J3.3 are concerned with  $l_e$  as hole spacing, whereas Section J3.4 is concerned with  $l_e$  as edge distance in the direction of stress.

Section J3.10 establishes a maximum bearing strength. Spacing and/or edge distance may be increased to provide for a required bearing strength, or bearing force may be reduced to satisfy a spacing and/or edge distance limitation.

It has long been known that the critical bearing stress of a single fastener connection is more dependent upon a given edge distance than multi-fastener connections (Jones, 1940). For this reason, longer edge distances (in the direction of force) are required for connections with one fastener in the line of transmitted force than required for those having two or more. The recommended minimum distance transverse to the direction of load is primarily a workmanship tolerance. It has little, if any, effect on the strength of the member.

## 5. Maximum Spacing and Edge Distance

Limiting the edge distance to not more than 12 times the thickness of an outside connected part, but not more than six in. (150 mm), is intended to provide for the exclusion of moisture in the event of paint failure, thus preventing corrosion between the parts which might accumulate and force these parts to separate. More restrictive limitations are required for connected parts of unpainted weathering steel exposed to atmospheric corrosion.

## 6. Design Tension or Shear Strength

Tension loading of fasteners is usually accompanied by some bending due to the deformation of the connected parts. Hence, the resistance factor  $\phi$ , by which  $R_n$  is multiplied to obtain the design tensile strength of fasteners, is relatively low. The nominal tensile strength values in Table J3.2 were obtained from the equation

$$R_n = 0.75 A_b F_u \quad (\text{C-J3-2})$$

This tensile strength given by Equation C-J3-2 is independent of whether the bolt

was initially installed pretensioned or snug-tightened. Recent tests (Johnson, 1996 and Murray, Kline, and Rojani, 1992) confirm that the performance of ASTM A325 and A325M bolts in tension not subjected to fatigue are unaffected by the original installation condition. While the equation was developed for bolted connections (Kulak et al., 1987), it was also conservatively applied to threaded parts and to rivets.

In connections consisting of only a few fasteners, the effects of strain on the shear in bearing fasteners is negligible (Kulak et al., 1987 and Fisher et al., 1978). In longer joints, the differential strain produces an uneven distribution between fasteners (those near the end taking a disproportionate part of the total load), so that the maximum strength per fastener is reduced. The AISC ASD Specification permits connections up to 50 in. (1 270 mm) in length without a reduction in maximum shear stress. With this in mind the resistance factor  $\phi$  for shear in bearing-type connections has been selected to accommodate the same range of connections.

The values of nominal shear strength in Table J3.2 were obtained from the equation

$$R_n / mA_b = 0.50 F_u \quad (\text{C-J3-3})$$

when threads are excluded from the shear planes and

$$R_n / mA_b = 0.40 F_u \quad (\text{C-J3-4})$$

when threads are not excluded from the shear plane, where  $m$  is the number of shear planes (Kulak et al., 1987). While developed for bolted connections, the equations were also conservatively applied to threaded parts and rivets. The value given for A307 bolts was obtained from Equation C-J3-4 but is specified for all cases regardless of the position of threads. For A325 or A325M bolts, no distinction is made between small and large diameters, even though the minimum tensile strength  $F_u$  is lower for bolts with diameters in excess of one inch. It was felt that such a refinement of design was not justified, particularly in view of the low resistance factor  $\phi$ , the increasing ratio of tensile area to gross area, and other compensating factors.

## 7. Combined Tension and Shear in Bearing-Type Connections

Tests have shown that the strength of bearing fasteners subject to combined shear and tension resulting from externally applied forces can be closely defined by an ellipse (Kulak et al., 1987). Such a curve can be replaced, with only minor deviations, by three straight lines as shown in Figure C-J3.3. This latter representation offers the advantage that no modification of either type stress is required in the presence of fairly large magnitudes of the other type. This linear representation was adopted for Table J3.5, giving a limiting tensile stress  $F_t$  as a function of the shearing stress  $f_v$  for bearing-type connections. Following a change in the 1994 RCSC *LRFD Specification for Structural Joints Using ASTM A325 or A490 Bolts*, the coefficients in the equations in Table J3.5 have been modified for consistency (Carter, Tide, and Yura, 1997).

## 8. High-Strength Bolts in Slip-Critical Connections

Connections classified as slip-critical include those cases where slip could theoretically exceed an amount deemed by the Engineer of Record to affect the suitability for service of the structure by excessive distortion or reduction in strength or stability, even though the nominal strength of the connection may be adequate. Also included are those cases where slip of any magnitude must be prevented, for exam-

ple, joints subject to fatigue, connectors between elements of built-up members at their ends (Sections D2 and E4), and bolts in combination with welds (Section J1.9).

The onset of slipping in a high-strength bolted, slip-critical connection is not an indication that the maximum strength of the connection has been reached. Its occurrence may be only a serviceability limit state. The design check for slip resistance can be made at two different load levels, factored loads (Sections J3.8a and J3.9a) and service loads (Appendices J3.8b and J3.9b). The nominal slip resistances  $r_{str}$  and  $F_v A_b$  to be used with factored loads and service loads, respectively, are based on two different design concepts. The slip resistance  $r_{str}$  with factored loads is the mean resistance per bolt, which is a function of the mean slip coefficient and the clamping force. The 1.13 factor in (Equation J3-1) accounts for the expected 13 percent increase above the minimum specified preload provided by calibrated wrench tightening procedures. This was used to represent typical installations. The factored load resistance  $r_{str}$  uses the  $\beta$  reliability index approach that is used for the other design checks such as tension and bearing. The service load approach uses a probability of slip concept that implies a 90 percent reliability that slip will not occur if the calibrated wrench method of bolt installation is used.

The Engineer of Record must make the determination to use factored loads, service loads, or both in checking the slip resistance of a slip-critical connection. The following commentary is provided as guidance and an indication of the intent of the Specification.

In the case of slip-critical connections with three or more bolts in holes with only a small clearance, such as standard holes and slotted holes loaded transversely to the axis of the slot, the freedom to slip does not generally exist because one or more bolts are in bearing even before load is applied due to normal fabrication tolerances and erection procedures. If connections with standard holes have only one or two bolts in the direction of the applied force, a small slip may occur. In this case, slip-critical connections subjected to vibration or wind should be checked for slip at service-load levels. In built-up compression members, such as double-angle struts

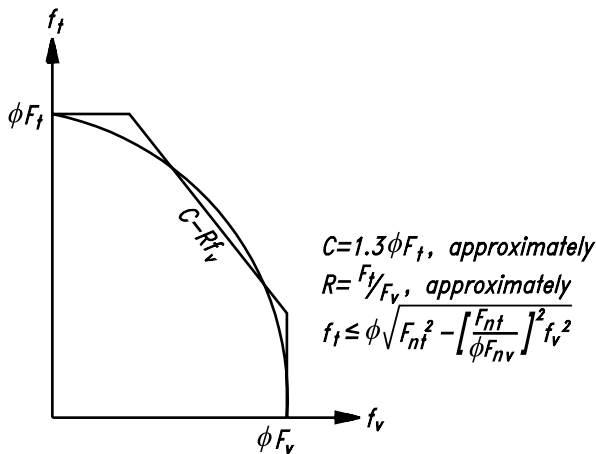

Fig. C-J3.3. Three straight line approximation.

in trusses, a small slip in the end connections can significantly reduce the strength of the compression member so the slip-critical end connection should be checked for slip at the factored-load level, whether or not a slip-critical connection is required by a serviceability requirement.

In connections with long slots that are parallel to the direction of the applied load, slip of the connection prior to attainment of the factored load might be large enough to alter the usual assumption of analysis that the undeformed structure can be used to obtain the internal forces. The Specification allows the designer two alternatives in this case. If the connection is designed so that it will not slip under the effects of service loads, then the effect of the factored loads acting on the deformed structure (deformed by the maximum amount of slip in the long slots at all locations) must be included in the structural analysis. Alternatively, the connection can be designed so that it will not slip at loads up to the factored load level.

Joints subjected to full reverse cyclical loading are clearly slip-critical joints since slip would permit back and forth movement of the joint and early fatigue. However, for joints subjected to pulsating load that does not involve reversal of direction, proper fatigue design could be provided either as a slip-critical joint on the basis of stress on the gross section, or as a non-slip-critical joint on the basis of stress on the net section. Because fatigue results from repeated application of the service load rather than the overload load, design should be based upon service-load criteria.

For high-strength bolts in combination with welds in statically loaded conditions and considering new work only, the nominal strength may be taken as the sum of the slip resistances provided by the bolts and the shear resistance of the welds. Section J1.9 requires that the slip resistance be determined at factored load levels. If one type of connector is already loaded when the second type of connector is introduced, the nominal strength cannot be obtained by adding the two resistances. The Guide (Kulak et al., 1987) should be consulted in these cases.

Slip of slip-critical connections is likely to occur at approximately 1.4 to 1.5 times the service loads. For standard holes, oversized holes, and short-slotted holes the connection can be designed either at service loads (Appendix J3.8b) or at factored loads (Section J3.8a). The nominal loads and  $\phi$  factors have been adjusted accordingly. The number of connectors will be essentially the same for the two procedures because they have been calibrated to give similar results. Slight differences will occur because of variation in the ratio of live load to dead load.

In connections containing long slots that are parallel to the direction of the applied load, slip of the connection prior to attainment of the factored load might be large enough to alter the usual assumption of analysis that the undeformed structure can be used to obtain the internal forces. To guard against this occurring, the design slip resistance is further reduced by 0.8 when designing at service load (Appendix J3.8b) and by setting  $\phi$  to 0.60 in conjunction with factored loads (Section J3.8a).

While the possibility of a slip-critical connection slipping into bearing under anticipated service conditions is small, such connections must comply with the provisions of Section J3.10 in order to prevent connection failure at the maximum load condition.

## 10. Bearing Strength at Bolt Holes

Provisions for bearing strength of pins differ from those for bearing strength of bolts; refer to Section J8.

Bearing values are provided as a measure of the strength of the material upon which a bolt bears, not as a protection to the fastener, which needs no such protection. Accordingly, the same bearing value applies to all joints assembled by bolts, regardless of fastener shear strength or the presence or absence of threads in the bearing area.

Material bearing strength may be limited either by bearing deformation of the hole or by block shear rupture of the material upon which the bolt bears. Recent testing by Kim and Yura (1996) and Lewis and Zwerneman (1996) has confirmed the bearing strength provisions for the former case wherein the nominal bearing strength  $R_n$  is equal to  $CdtF_u$  and  $C$  is 2.4, 3.0, or 2.0 depending upon hole type and/or acceptability of hole ovalization at ultimate load as indicated in LRFD Specification Section J3.10. However, this same research indicated the need for more accurate bearing strength provisions when block-shear-rupture-type failure would control. Appropriate equations for bearing strength as a function of clear distance  $L_c$  are therefore provided and this formulation is consistent with that adopted by RCSC in the *Load and Resistance Factor Design Specification for Structural Joints Using ASTM A325 or A490 Bolts* (RCSC, 1994).

Frank and Yura (1981) demonstrated that hole elongation greater than  $\frac{1}{4}$  in. (6 mm) will generally begin to develop as the bearing force is increased beyond  $\phi(2.4dtF_u)$ , especially if it is combined with high tensile stress on the net section, even though rupture does not occur; for a long-slotted hole with the slot perpendicular to the direction of force, the same is true for a bearing force greater than  $\phi(2.0dtF_u)$ . An upper bound of  $\phi(3.0dtF_u)$  anticipates hole ovalization (deformation greater than  $\frac{1}{4}$  in. (6 mm)) at maximum load.

Additionally, to simplify and generalize such bearing strength calculations, the current provisions have been based upon a clear-distance formulation. Previous provisions utilized edge distances and bolt spacings measured to hole centerlines with adjustment factors to account for varying hole type and orientation, as well as minimum edge distance requirements.

## 11. Long Grips

Provisions requiring a decrease in calculated stress for A307 bolts having long grips (by arbitrarily increasing the required number in proportion to the grip length) are not required for high-strength bolts. Tests (Bendigo, Hansen, and Rumpf, 1963) have demonstrated that the ultimate shearing strength of high-strength bolts having a grip of eight or nine diameters is no less than that of similar bolts with much shorter grips.

## J4. DESIGN RUPTURE STRENGTH

Tests (Birkemoe and Gilmor, 1978) on coped beams indicated that a tearing failure mode (rupture) can occur along the perimeter of the bolt holes as shown in Figure C-J4.1. This block shear mode combines tensile strength on one plane and shear strength on a perpendicular plane. The failure path is defined by the center lines of

the bolt holes. The block shear failure mode is not limited to the coped ends of beams. Other examples are shown in Figure C-J4.1 and C-J4.2.

The block shear failure mode should also be checked around the periphery of welded connections. Welded connection block shear is determined using  $\phi=0.75$  in conjunction with the area of both the fracture and yielding planes (Yura, 1988).

The LRFD Specification has adopted a conservative model to predict block shear strength. Test results suggest that it is reasonable to add the yield strength on one plane to the rupture strength of the perpendicular plane (Ricles and Yura, 1983, and Hardash and Bjorhovde, 1985). Therefore, two possible block shear strengths can be calculated; rupture strength  $F_u$  on the net tensile section along with shear yielding  $0.6F_y$  on the gross section on the shear plane(s), or rupture  $0.6F_u$  on the net shear area(s) combined with yielding  $F_y$  on the gross tensile area. This is the basis of Equations J4-3a and J4-3b.

These equations are consistent with the philosophy in Chapter D for tension members, where gross area is used for the limit state of yielding and net area is used for rupture. The controlling equation is the one that produces the *larger* rupture force.

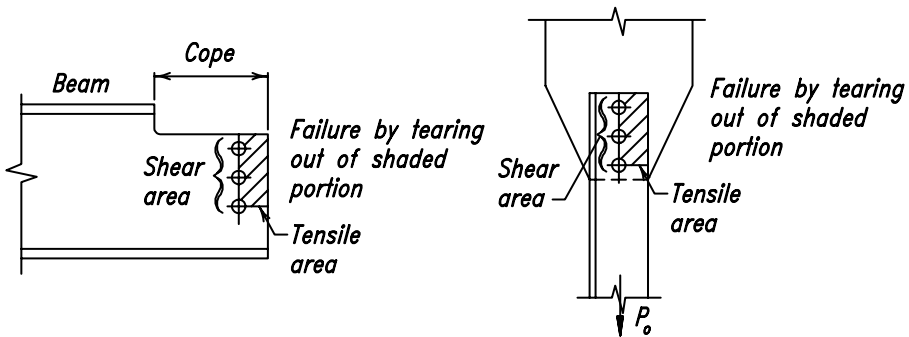

Fig. C-J4.1. Failure for block shear rupture limit state.

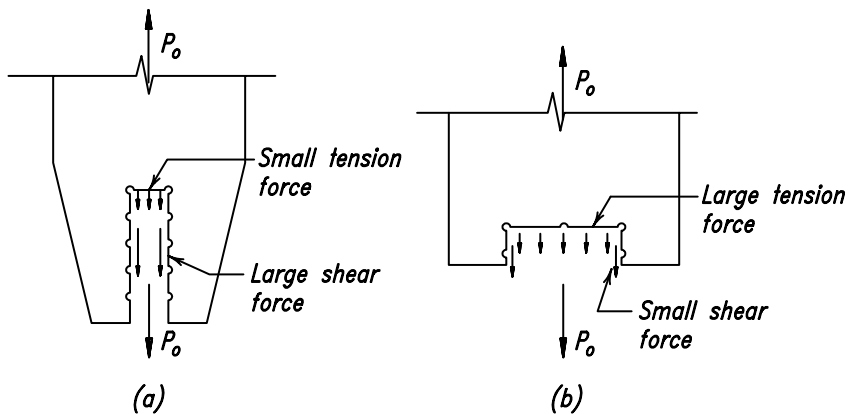

Fig. C-J4.2. Block shear rupture in tension.



This can be explained by the two extreme examples given in Figure C-J4.2. In Case (a), the total force is resisted primarily by shear, so shear rupture, not shear yielding, should control the block shear tearing mode; therefore, use Equation J4-3b. For Case (b), block shear cannot occur until the tension area ruptures as given by Equation J4-3a. If Equation J4-3b (shear rupture on the small area and yielding on the large tension area) is checked for Case (b), a smaller  $P_o$  will result. In fact, as the shear area gets smaller and approaches zero, the use of Equation J4-3b for Case (b) would give a block shear strength based totally on *yielding* of the gross tensile area. Block shear is a rupture or tearing phenomenon not a yielding limit state. Therefore, the proper equation to use is the one with the larger rupture term.

## J5. CONNECTING ELEMENTS

### 2. Design Strength of Connecting Elements in Tension

Tests have shown that yield will occur on the gross section area before the tensile capacity of the net section is reached, if the ratio  $A_n/A_g \leq 0.85$  (Kulak et al., 1987). Since the length of connecting elements is small compared to the member length, inelastic deformation of the gross section is limited. Hence, the effective net area  $A_n$  of the connecting element is limited to  $0.85A_g$  in recognition of the limited inelastic deformation and to provide a reserve capacity.

## J6. FILLERS

The practice of securing fillers by means of additional fasteners, so that they are, in effect, an integral part of a shear-connected component, is not required where a connection is designed to be a slip-critical connection using high-strength bolts. In such connections, the resistance to slip between filler and either connected part is comparable to that which would exist between the connected parts if no fill were present.

Filler plates may be used in lap joints of welded connections that splice parts of different thickness, or where there may be an offset in the joint.

## J8. BEARING STRENGTH

The LRFD Specification provisions for bearing on milled surfaces, Section J8, follow the same philosophy of earlier AISC ASD Specifications. In general, the design is governed by a deformation limit state at service loads resulting in stresses nominally at  $\%$  of yield. Adequate safety is provided by post-yield strength as deformation increases. Tests on pin connections (Johnston, 1939) and on rockers (Wilson, 1934) have confirmed this behavior.

As used throughout the LRFD Specification, the terms “milled surface,” “milled,” and “milling” are intended to include surfaces which have been accurately sawed or finished to a true plane by any suitable means.

## J9. COLUMN BASES AND BEARING ON CONCRETE

The equations for resistance of concrete in bearing are the same as ACI 318-99 except that AISC equations use  $\phi = 0.60$  while ACI uses  $\phi = 0.70$ , since ACI specifies larger load factors than the ASCE load factors stipulated by AISC.

See DeWolf and Ricker (1990) for guidelines on the design of column base plates.

## CHAPTER K

### CONCENTRATED FORCES, PONDING, AND FATIGUE

#### K1. FLANGES AND WEBS WITH CONCENTRATED FORCES

##### 1. Design Basis

The LRFD Specification separates flange and web strength requirements into distinct categories representing different limit state criteria, i.e., flange local bending (Section K1.2), web local yielding (Section K1.3), web crippling (Section K1.4), web sidesway buckling (Section K1.5), web compression buckling (Section K1.6), and web panel-zone shear (Section K1.7).

These criteria are applied to two distinct types of concentrated forces which act on member flanges. *Single concentrated forces* may be tensile, such as those delivered by tension hangers, or compressive, such as those delivered by bearing plates at beam interior positions, reactions at beam ends, and other *bearing* connections. *Double concentrated forces*, one tensile and one compressive, form a couple on the same side of the loaded member, such as that delivered to column flanges through welded and bolted *moment* connections. See Carter (1999) for guidelines on column stiffener design.

##### 2. Flange Local Bending

Where a tensile force is applied through a plate welded across a flange, that flange must be sufficiently rigid to prevent deformation of the flange and the corresponding high-stress concentration in the weld in line with the web.

The effective column flange length for local flange bending is  $12t_f$  (Graham, et al., 1959). Thus, it is assumed that yield lines form in the flange at  $6t_f$  in each direction from the point of the applied concentrated force. To develop the fixed edge consistent with the assumptions of this model, an additional  $4t_f$  and therefore a total of  $10t_f$  is required for the full flange-bending strength given by Equation K1-1. In the absence of applicable research, a 50 percent reduction has been introduced for cases wherein the applied concentrated force is less than  $10t_f$  from the member end.

This criterion given by Equation K1-1 was originally developed for *moment* connections, but it also applies to *single concentrated forces* such as tension hangers consisting of a plate welded to the bottom flange of a beam and transverse to the beam web.

##### 3. Web Local Yielding

The web strength criteria have been established to limit the stress in the web of a member into which a force is being transmitted. It should matter little whether the member receiving the force is a beam or a column; however, Galambos (1976) and AISC (1978), references upon which the LRFD Specification is based, did make

such a distinction. For beams, a 2:1 stress gradient through the flange was used, whereas the gradient through column flanges was 2½:1. In Section K1.3, the 2½:1 gradient is used for both cases.

This criterion applies to both *bearing* and *moment* connections.

**4. Web Crippling**

The expression for resistance to web crippling at a concentrated force is a departure from earlier specifications (IABSE, 1968; Bergfelt, 1971; Hoglund, 1971; and Elgaaly, 1983). Equations K1-4 and K1-5 are based on research by Roberts (1981). The increase in Equation K1-5b for  $N/d > 0.2$  was developed after additional testing (Elgaaly and Salkar, 1991) to better represent the effect of longer bearing lengths at ends of members. All tests were conducted on bare steel beams without the expected beneficial contributions of any connection or floor attachments. Thus, the resulting criteria are considered conservative for such applications.

These equations were developed for *bearing* connections, but are also generally applicable to *moment* connections. However, for the rolled shapes listed in Part 1 of the LRFD Manual with  $F_y$  not greater than 50 ksi (345 MPa), the web crippling criterion will never control the design in a *moment* connection except for a W12×50 (W310×74) or W10×33 (W250×49.1) column.

The web crippling phenomenon has been observed to occur in the web adjacent to the loaded flange. For this reason, a half-depth stiffener (or stiffeners) or a half-depth doubler plate is expected to eliminate this limit state.

**5. Web Sidesway Buckling**

The web sidesway buckling criterion was developed after observing several unexpected failures in tested beams (Summers and Yura, 1982). In those tests the compression flanges were braced at the concentrated load, the web was squeezed into compression, and the tension flange buckled (see Figure C-K1.1).

Web sidesway buckling will not occur in the following cases. For flanges restrained against rotation:

$$\frac{h/t_w}{l/b_f} > 2.3 \tag{C-K1-1}$$

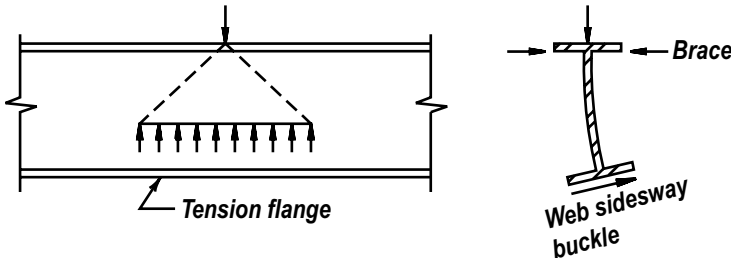

Fig. C-K1.1. Web sidesway buckling.

For flanges *not* restrained against rotation:

$$\frac{h/t_w}{l/b_f} > 1.7 \quad (\text{C-K1-2})$$

where  $l$  is as shown in Figure C-K1.2.

Web sidesway buckling can also be prevented by the proper design of lateral bracing or stiffeners at the load point. It is suggested that local bracing at both flanges be designed for one percent of the concentrated force applied at that point. Stiffeners must extend from the load point through at least one-half the beam or girder depth. In addition, the pair of stiffeners should be designed to carry the full load. If flange rotation is permitted at the loaded flange, neither stiffeners nor doubler plates will be effective.

In the 1st Edition LRFD Manual, the web sidesway buckling equations were based on the assumption that  $h/t_f = 40$ , a convenient assumption which is generally true for economy beams. This assumption has been removed so that the equations will be applicable to all sections.

This criterion was developed only for *bearing* connections and does not apply to *moment* connections.

## 6. Web Compression Buckling

When compressive forces are applied to both flanges of a member at the same loca-

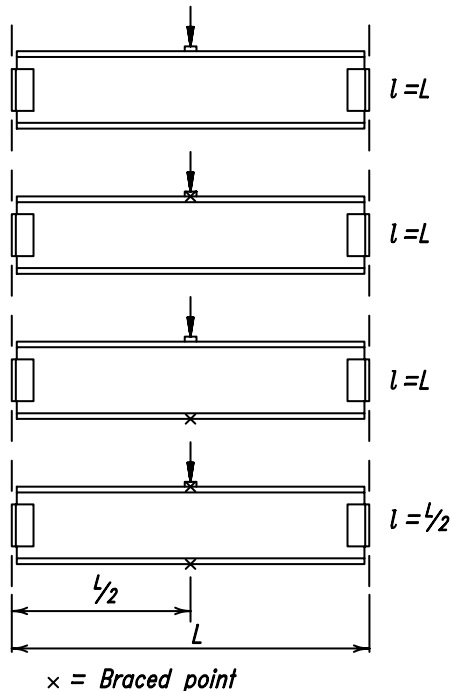

Fig. C-K1.2. Unbraced flange length.

tion, as by *moment* connections at both flanges of a column, the member web must have its slenderness ratio limited to avoid the possibility of buckling. This is done in the LRFD Specification with Equation K1-8, which is a modified form of a similar equation used in the ASD Specification. This equation is applicable to a pair of *moment* connections, and to other pairs of compressive forces applied at both flanges of a member, for which  $N/d$  is small ( $<1$ ). When  $N/d$  is not small, the member web should be designed as a compression member in accordance with Chapter E.

Equation K1-8 is predicated on an interior member loading condition. In the absence of applicable research, a 50 percent reduction has been introduced for cases wherein the compressive forces are close to the member end.

Equation K1-8 has also traditionally been applied when there is a *moment* connection to only one flange of the column and compressive force is applied to only one flange. Its use in this case is conservative.

**7. Web Panel-Zone Shear**

The column web shear stresses may be high within the boundaries of the rigid connection of two or more members whose webs lie in a common plane. Such webs should be reinforced when the calculated factored force  $\Sigma F_u$  along plane A-A in Figure C-K1.3 exceeds the column web design strength  $\phi R_v$ , where

$$\Sigma F_u = \frac{M_{u1}}{d_{m1}} + \frac{M_{u2}}{d_{m2}} - V_u \tag{C-K1-3}$$

and

$M_{u1} = M_{u1L} + M_{u1G}$  = the sum of the moments due to the factored lateral load  $M_{u1L}$  and the moments due to factored gravity load  $M_{u1G}$  on the windward side of the connection, kip-in. (N-mm)

$M_{u2} = M_{u2L} + M_{u2G}$  = the difference between the moments due to the factored lateral load  $M_{u2L}$  and the moments due to factored gravity

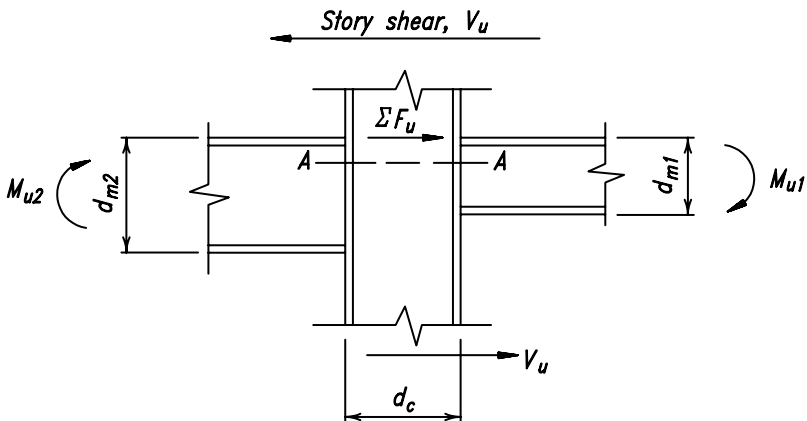

Fig. C-K1.3. Forces in panel zone.

load  $M_{u2G}$  on the windward side of the connection, kip-in.  
(N-mm)

$d_{m1}, d_{m2}$  = distance between flange forces in a moment connection,  
in. (mm)

Conservatively, 0.95 times the beam depth has been used for  $d_m$  in the past.

If  $\Sigma F_u \leq \phi R_v$ , no reinforcement is necessary, i.e.,  $t_{req} \leq t_w$ , where  $t_w$  is the column web thickness.

Consistent with elastic first order analysis, Equations K1-9 and K1-10 limit panel-zone behavior to the elastic range. While such connection panels possess large reserve capacity beyond initial general shear yielding, the corresponding inelastic joint deformations may adversely affect the strength and stability of the frame or story (Fielding and Huang, 1971, and Fielding and Chen, 1973). Panel-zone shear yielding affects the overall frame stiffness and, therefore, the ultimate-strength second-order effects may be significant. The shear/axial interaction expression of Equation K1-10, as shown in Figure C-K1.4, is chosen to ensure elastic panel behavior.

If adequate connection ductility is provided and the frame analysis considers the inelastic panel-zone deformations, then the additional inelastic shear strength is recognized in Equations K1-11 and K1-12 by the factor

$$\left( 1 + \frac{3b_{cf}t_{cf}^2}{d_b d_c t_w} \right)$$

This inelastic shear strength has been most often utilized for design of frames in high seismic zones and should be used when the panel zone is to be designed to match the strength of the members from which it is formed.

The shear/axial interaction expression incorporated in Equation K1-12 (see Figure C-K1.5) is similar to that contained in the previous editions of this Specification

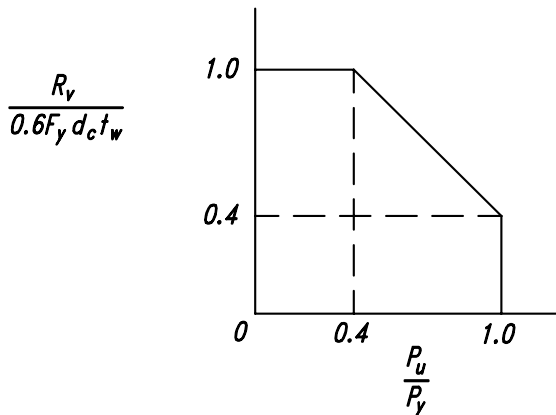

Fig. C-K1.4. Interaction of shear and axial force—elastic.

and recognizes the observed fact that when the panel-zone web has completely yielded in shear, the axial column load is carried in the flanges.

**K2. PONDING**

As used in the LRFD Specification, *ponding* refers to the retention of water due solely to the deflection of flat roof framing. The amount of this water is dependent upon the flexibility of the framing. Lacking sufficient framing stiffness, its accumulated weight can result in collapse of the roof if a strength evaluation is not made.

Representing the deflected shape of the primary and critical secondary member as a half-sine wave, the weight and distribution of the ponded water can be estimated and, from this, the contribution that the deflection each of these members makes to the total ponding deflection can be expressed (Marino, 1966):

For the primary member:

$$\Delta_w = \frac{\alpha_p \Delta_o [1 + 0.25\pi\alpha_s + 0.25\pi\rho(1 + \alpha_s)]}{1 - 0.25\pi\alpha_p\alpha_s}$$

For the secondary member:

$$\delta_w = \frac{\alpha_s \delta_o \left[ 1 + \frac{\pi^2}{32}\alpha_p + \frac{\pi^2}{8\rho}(1 + \alpha_p) + 0.185\alpha_s\alpha_p \right]}{1 - 0.25\pi\alpha_p\alpha_s}$$

In these expressions  $\Delta_o$  and  $\delta_o$  are, respectively, the primary and secondary beam deflections due to loading present at the initiation of ponding,

$$\alpha_p = C_p / (1 - C_p), \alpha_s = C_s / (1 - C_s), \text{ and } \rho = \delta_o / \Delta_o = C_s / C_p$$

Using the above expressions for  $\Delta_w$  and  $\delta_w$ , the ratios  $\Delta_w/\Delta_o$  and  $\delta_w/\delta_o$  can be computed for any given combination of primary and secondary beam framing using, respectively, the computed value of parameters  $C_p$  and  $C_s$  defined in the LRFD Specification.

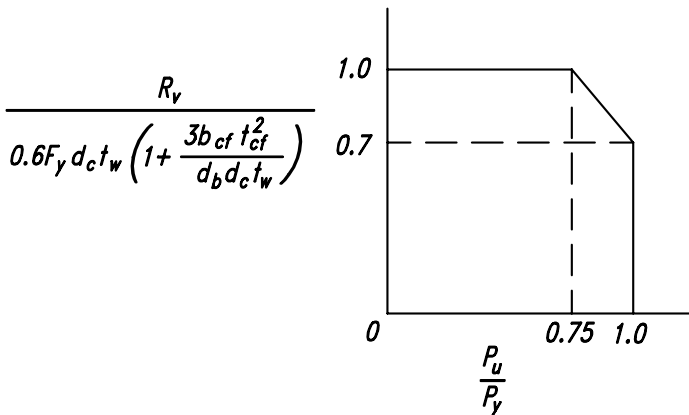

Fig. C-K1.5. Interaction of shear and axial force—inelastic.

Even on the basis of unlimited elastic behavior, it is seen that the ponding deflections would become infinitely large unless

$$\left( \frac{C_p}{1 - C_p} \right) \left( \frac{C_s}{1 - C_s} \right) < \frac{4}{\pi}$$

Since elastic behavior is not unlimited, the effective bending strength available in each member to resist the stress caused by ponding action is restricted to the difference between the yield stress of the member and the stress  $f_o$  produced by the total load supported by it before consideration of ponding is included.

Note that elastic deflection is directly proportional to stress. The admissible amount of ponding in either the primary or critical (midspan) secondary member, in terms of the applicable ratio  $\Delta_w / \Delta_o$  and  $\delta_w / \delta_o$ , can be represented as  $(F_y - f_o) / f_o$ . Substituting this expression for  $\Delta_w / \Delta_o$  and  $\delta_w / \delta_o$ , and combining with the foregoing expressions for  $\Delta_w$  and  $\delta_w$ , the relationship between critical values for  $C_p$  and  $C_s$  and the available elastic bending strength to resist ponding is obtained. The curves presented in Figures A-K2.1 and A-K2.2 are based upon this relationship. They constitute a design aid for use when a more exact determination of required flat roof framing stiffness is needed than given by the LRFD Specification provision that  $C_p + 0.9C_s \leq 0.25$ .

Given any combination of primary and secondary framing, the stress index is computed as

$$U_p = \left( \frac{F_y - f_o}{f_o} \right)_p \quad \text{for the primary member}$$

$$U_s = \left( \frac{F_y - f_o}{f_o} \right)_s \quad \text{for the secondary member}$$

where  $f_o$ , in each case, is the computed bending stress, ksi (MPa), in the member due to the supported loading, neglecting ponding effect. Depending upon geographic location, this loading should include such amount of snow as might also be present, although ponding failures have occurred more frequently during torrential summer rains when the rate of precipitation exceeded the rate of drainage runoff and the resulting hydraulic gradient over large roof areas caused substantial accumulation of water some distance from the eaves.

Given the size, spacing, and span of a tentatively selected combination of primary and secondary beams, for example, one may enter Figure A-K2.1 at the level of the computed stress index  $U_p$ , determined for the primary beam; move horizontally to the computed  $C_s$  value of the secondary beams; then move downward to the abscissa scale. The combined stiffness of the primary and secondary framing is sufficient to prevent ponding if the flexibility constant read from this latter scale is more than the value of  $C_p$  computed for the given primary member; if not, a stiffer primary or secondary beam, or combination of both, is required.

If the roof framing consists of a series of equally-spaced wall-bearing beams, they would be considered as secondary members, supported on an infinitely stiff primary member. For this case, one would use Figure A-K2.2. The limiting value of  $C_s$



would be determined by the intercept of a horizontal line representing the  $U_s$  value and the curve for  $C_p = 0$ .

The ponding deflection contributed by a metal deck is usually such a small part of the total ponding deflection of a roof panel that it is sufficient merely to limit its moment of inertia [in.<sup>4</sup> per foot (mm<sup>4</sup> per meter) of width normal to its span] to 0.000025 (3 940) times the fourth power of its span length, as provided in the LRFD Specification. However, the stability against ponding of a roof consisting of a metal roof deck of relatively slender depth-span ratio, spanning between beams supported directly on columns, may need to be checked. This can be done using Figure A-K2.1 or A-K2.2 with the following computed values:

$U_p$  = stress index for the supporting beam

$U_s$  = stress index for the roof deck

$C_p$  = flexibility constant for the supporting beams

$C_s$  = flexibility constant for one foot width of the roof deck ( $S = 1.0$ )

Since the shear rigidity of the web system is less than that of a solid plate, the moment of inertia of steel joists and trusses should be taken as somewhat less than that of their chords.

# CHAPTER L

## SERVICEABILITY DESIGN CONSIDERATIONS

Serviceability criteria are formulated to prevent disruptions of the functional use and damage to the structure during its normal everyday use. While malfunctions may not result in the collapse of a structure or in loss of life or injury, they can seriously impair the usefulness of the structure and lead to costly repairs. Neglect of serviceability may result in unacceptably flexible structures.

There are essentially three types of structural behavior which may impair serviceability:

- (1) Excessive local damage (local yielding, buckling, slip, or cracking) that may require excessive maintenance or lead to corrosion.
- (2) Excessive deflection or rotation that may affect the appearance, function, or drainage of the structure, or may cause damage to nonstructural components and their attachments.
- (3) Excessive vibrations induced by wind or transient live loads which affect the comfort of occupants of the structure or the operation of mechanical equipment.

In allowable stress design, the AISC Specification accounts for possible local damage with factors of safety included in the allowable stresses, while deflection and vibration are controlled, directly or indirectly, by limiting deflections and span-depth ratios. In the past, these rules have led to satisfactory performance of structures, with perhaps the exception of large open floor areas without partitions. In LRFD the serviceability checks should consider the appropriate loads, the response of the structure, and the reaction of the occupants to the structural response.

Examples of loads that may require consideration of serviceability include permanent live loads, wind, and earthquake; effects of human activities such as walking, dancing, etc.; temperature fluctuations; and vibrations induced by traffic near the building or by the operation of mechanical equipment within the building.

Serviceability checks are concerned with adequate performance under the appropriate load conditions. Elastic behavior can usually be assumed. However, some structural elements may have to be examined with respect to their long-term behavior under load.

It is difficult to specify limiting values of structural performance based on serviceability considerations because these depend to a great extent on the type of structure, its intended use, and subjective physiological reaction. For example, acceptable structural motion in a hospital clearly would be much less than in an ordinary industrial building. It should be noted that humans perceive levels of structural motion that are far less than motions that would cause any structural damage. Serviceability limits must be determined through careful consideration by the designer and client.

Serviceability guidelines for low-rise buildings are given in Fisher and West (1990).

## **L1. CAMBER**

The engineer should consider specifying camber when deflections at the appropriate load level present a serviceability problem.

## **L2. EXPANSION AND CONTRACTION**

As in the case of deflections, the satisfactory control of expansion cannot be reduced to a few simple rules, but must depend largely upon the good judgment of qualified engineers.

The problem is more serious in buildings with masonry walls than with prefabricated units. Complete separation of the framing, at widely spaced expansion joints, is generally more satisfactory than more frequently located devices dependent upon the sliding of parts in bearing, and usually less expensive than rocker or roller expansion bearings.

Creep and shrinkage of concrete and yielding of steel are among the causes, other than temperature, for dimensional changes.

## **L3. DEFLECTIONS, VIBRATION, AND DRIFT**

### **1. Deflections**

Excessive transverse deflections or lateral drift may lead to permanent damage to building elements, separation of cladding, or loss of weathertightness, damaging transfer of load to non-load-supporting elements, disruption of operation of building service systems, objectionable changes in appearance of portions of the buildings, and discomfort of occupants.

The LRFD Specification does not provide specific limiting deflections for individual members or structural assemblies. Such limits would depend on the function of the structure (ASCE, 1979; CSA, 1989; and Ad Hoc Committee on Serviceability Research, 1986). Provisions that limit deflections to a percentage of span may not be adequate for certain long-span floor systems; a limit on maximum deflection that is independent of span length may also be necessary to minimize the possibility of damage to adjoining or connecting nonstructural elements.

Deflection calculations for composite beams should include an allowance for slip for short-term deflection calculations, and for creep and shrinkage for long-term deflection calculations (see Commentary Section I3.2).

### **2. Floor Vibration**

The increasing use of high-strength materials and efficient structural schemes leads to longer spans and more flexible floor systems. Even though the use of a deflection limit related to span length generally precluded vibration problems in the past, some floor systems may require explicit consideration of the dynamic, as well as the static, characteristics of the floor system.

The dynamic response of structures or structural assemblies may be difficult to analyze because of difficulties in defining the actual mass, stiffness, and damping characteristics. Moreover, different load sources cause varying responses. For example, a steel beam-concrete slab floor system may respond to live loading as a non-composite system, but to transient excitation from human activity as an

orthotropic composite plate. Nonstructural partitions, cladding, and built-in furniture significantly increase the stiffness and damping of the structure and frequently eliminate potential vibration problems. The damping can also depend on the amplitude of excitation.

The general objective in minimizing problems associated with excessive structural motion is to limit accelerations, velocities, and displacements to levels that would not be disturbing to the building occupants. Generally, occupants of a building find sustained vibrations more objectionable than transient vibrations.

The levels of peak acceleration that people find annoying depend on frequency of response. Thresholds of annoyance for transient vibrations are somewhat higher and depend on the amount of damping in the floor system. These levels depend on the individual and the activity at the time of excitation (ASCE, 1979; ISO, 1974; CSA, 1989; Murray, Allen, and Ungar, 1997; and Ad Hoc Committee on Serviceability Research, 1986).

The most effective way to reduce effects of continuous vibrations is through vibration isolation devices. Care should be taken to avoid resonance, where the frequency of steady-state excitation is close to the fundamental frequency of the system. Transient vibrations are reduced most effectively by increasing the damping in the structural assembly. Mechanical equipment which can produce objectionable vibrations in any portion of a structure should be adequately isolated to reduce the transmission of such vibrations to critical elements of the structure.

### **3. Drift**

The LRFD Specification does not provide specific limiting values for lateral drift. If a drift analysis is desired, the stiffening effect of non-load-supporting elements such as partitions and infilled walls may be included in the analysis of drift.

Some irrecoverable inelastic deformations may occur at given load levels in certain types of construction. The effect of such deformations may be negligible or serious, depending on the function of the structure, and should be considered by the designer on a case by case basis.

The deformation limits should apply to structural assemblies as a whole. Reasonable tolerance should also be provided for creep. Where load cycling occurs, consideration should be given to the possibility of increases in residual deformation that may lead to incremental failure.

## **L5. CORROSION**

Steel members may deteriorate in particular service environments. This deterioration may appear either in external corrosion, which would be visible upon inspection, or in undetected changes that would reduce its strength. The designer should recognize these problems by either factoring a specific amount of damage tolerance into the design or providing adequate protection systems (e.g., coatings, cathodic protection) and/or planned maintenance programs so that such problems do not occur.

## CHAPTER M

### FABRICATION, ERECTION, AND QUALITY CONTROL

#### M2. FABRICATION

##### 1. Cambering, Curving, and Straightening

The use of heat for straightening or cambering members is permitted for A514/A514M and A852/A852M steel, as it is for other steels. However, the maximum temperature permitted is 1,100°F (593°C) compared to 1,200°F (649°C) for other steels.

Cambering of flexural members, when required by the contract documents, may be accomplished in various ways. In the case of trusses and girders, the desired curvature can be built in during assembly of the component parts. Within limits, rolled beams can be cold-cambered at the producing mills.

Local application of heat has come into common use as a means of straightening or cambering beams and girders. The method depends upon an ultimate shortening of the heat-affected zones. A number of such zones, on the side of the member that would be subject to compression during cold-cambering or “gagging,” are heated enough to be “upset” by the restraint provided by surrounding unheated areas. Shortening takes place upon cooling.

While the final curvature or camber can be controlled by these methods, it must be realized that some deviation, due to workmanship error and permanent change due to handling, is inevitable.

##### 2. Thermal Cutting

Preferably thermal cutting shall be done by machine. The requirement for a positive preheat of 150°F (66°C) minimum when thermal cutting beam copes and weld access holes in ASTM A6/A6M Group 4 and 5 shapes, and in built-up shapes made of material more than two in. (50 mm) thick, tends to minimize the hard surface layer and the initiation of cracks.

##### 5. Bolted Construction

In the past, it has been required to tighten all ASTM A325 or A325M and A490 or A490M bolts in both slip-critical and bearing-type connections to a specified tension. The requirement was changed in 1985 to permit most bearing-type connections to be tightened to a snug-tight condition.

In a snug-tight bearing connection, the bolts cannot be subjected to tension loads, slip can be permitted, and loosening or fatigue due to vibration or load fluctuations are not design considerations.

It is suggested that snug-tight bearing-type connections be used in applications where A307 bolts would be permitted.

This section provides rules for the use of oversized and slotted holes paralleling the provisions which have been in the RCSC Specification (RCSC, 1994) since 1972, extended to include A307 bolts which are outside the scope of the high-strength bolt specifications.

### **M3. SHOP PAINTING**

The surface condition of steel framing disclosed by the demolition of long-standing buildings has been found to be unchanged from the time of its erection, except at isolated spots where leakage may have occurred. Even in the presence of leakage, the shop coat is of minor influence (Bigos, Smith, Ball, and Foehl, 1954).

The LRFD Specification does not define the type of paint to be used when a shop coat is required. Conditions of exposure and individual preference with regard to finish paint are factors which bear on the selection of the proper primer. Hence, a single formulation would not suffice. For a comprehensive treatment of the subject, see SSPC (1989).

#### **5. Surfaces Adjacent to Field Welds**

The Specification allows for welding through surface materials, including appropriate shop coatings, that do not adversely affect weld quality nor create objectionable fumes.

### **M4. ERECTION**

#### **2. Bracing**

For information on the design of temporary lateral support systems and components for low-rise building, see Fisher and West (1997).

#### **4. Fit of Column Compression Joints and Base Plates**

Tests at the University of California-Berkeley (Popov and Stephen, 1977) on spliced full-size columns with joints that had been intentionally milled out-of-square, relative to either strong or weak axis, demonstrated that the load-carrying capacity was the same as that for a similar unspliced column. In the tests, gaps of  $\frac{1}{16}$ -in. (2 mm) were not shimmed; gaps of  $\frac{1}{4}$ -in. (6 mm) were shimmed with non-tapered mild steel shims. Minimum size partial-joint-penetration welds were used in all tests. No tests were performed on specimens with gaps greater than  $\frac{1}{4}$ -in. (6 mm).

#### **5. Field Welding**

The purpose of wire brushing shop paint on surfaces adjacent to joints to be field welded is to reduce the possibility of porosity and cracking and also to reduce any environmental hazard. Although there are limited tests which indicate that painted surfaces result in sound welds without wire brushing, other studies have resulted in excessive porosity and/or cracking when welding coated surfaces. Wire brushing to reduce the paint film thickness minimizes rejectable welds. Grinding or other procedures beyond wire brushing is not necessary.

# CHAPTER N

## EVALUATION OF EXISTING STRUCTURES

### N1. GENERAL PROVISIONS

The load combinations referred to in this chapter reflect gravity loading because it is the most prevalent condition encountered. If other loading conditions are a consideration, such as lateral loads, the appropriate load combination from ASCE 7 (ASCE, 1998) or from the applicable building code should be used. Guidelines for seismic evaluation are available in other publications (FEMA, 1997a and 1997b). The Engineer of Record for a project is generally established by the owner.

### N2. MATERIAL PROPERTIES

#### 1. Determination of Required Tests

The extent of tests required depends on the nature of the project, the criticality of the structural system or member evaluated, and the availability of records pertinent to the project. Thus, the Engineer of Record is required to determine the specific tests required and the locations from which specimens are to be obtained.

#### 2. Tensile Properties

Samples required for tensile tests should be removed from regions of reduced stress, such as at flange tips at beam ends and external plate edges, to minimize the effects of the reduced area. The number of tests required will depend on whether they are conducted to merely confirm the strength of a known material or to establish the strength of some other steel. Guidance on the appropriate minimum number of tests is available (FEMA, 1997a).

It should be recognized that the yield stress determined by standard ASTM methods and reported by mills and testing laboratories is somewhat greater than the *static* yield stress because of dynamic effects of testing. Also, the test specimen location may have an effect. These effects have already been accounted for in the nominal strength equations in the Specification. However, when strength evaluation is done by load testing, this effect should be accounted for in test planning because yielding will tend to occur earlier than otherwise anticipated. The static yield stress,  $F_{ys}$ , can be estimated from that determined by routine application of ASTM methods,  $F_y$ , by the following equation (Galambos, 1978 and 1998):

$$F_{ys} = R(F_y - 4) \quad (\text{C-N2-1})$$

$$(\text{Metric: } F_{ys} = R(F_y - 27)) \quad (\text{C-N2-1M})$$

where

$F_{ys}$  = static yield stress, ksi (MPa)

$F_y$  = reported yield stress, ksi (MPa)

$R = 0.95$  for tests taken from web specimens

$R = 1.00$  for tests taken from flange specimens

The  $R$  factor in Equation C-N2-1 accounts for the effect of the coupon location on the reported yield stress. Prior to 1997, certified mill test reports for structural shapes were based on specimens removed from the web, in accordance with ASTM A6/A6M. Subsequently the specified coupon location was changed to the flange. During 1997-1998, there was a transition from web specimens to flange specimens as the new provisions of ASTM A6/A6M were adopted.

#### **4. Base Metal Notch Toughness**

The Engineer of Record shall specify the location of samples. Samples shall be cored, flame cut, or saw cut. The Engineer of Record will determine if remedial actions are required, such as the possible use of bolted splice plates.

#### **5. Weld Metal**

Because connections typically have a greater reliability index than structural members, strength testing of weld metal is not usually necessary. However, field investigations have sometimes indicated that complete-joint-penetration welds, such as at beam-to-column connections, were not made in accordance with AWS D1.1 (AWS, 1998). The specified provisions in Section N2.4 provide a means for judging the quality of such a weld. Where feasible, any samples removed should be obtained from compression splices rather than tension splices, because the effects of repairs to restore the sampled area are less critical.

#### **6. Bolts and Rivets**

Because connections typically have a greater reliability index than structural members, removal and strength testing of fasteners is not usually necessary. However, strength testing of bolts is required where they can not be properly identified otherwise. Because removal and testing of rivets is difficult, assuming the lowest rivet strength grade simplifies the investigation.

### **N3. EVALUATION BY STRUCTURAL ANALYSIS**

#### **2. Strength Evaluation**

Resistance factors reflect variations in determining strength of members and connections, such as uncertainty in theory and variations in material properties and dimensions. If an investigation of an existing structure indicates that there are variations in material properties or dimensions significantly greater than those anticipated in new construction, the Engineer of Record should consider the use of more conservative values.

### **N4. EVALUATION BY LOAD TESTS**

#### **1. Determination of Live Load Rating by Testing**

Generally, structures that can be designed according to the provisions of this Specification need no confirmation of calculated results by test. However, special situations may arise when it is desirable to confirm by tests the results of calculations. Minimal test procedures are provided to determine the live load rating of a structure. However, in no case is the live load rating determined by test to exceed that



which can be calculated using the provisions of the Specification. This is not intended to preclude testing to evaluate special conditions or configurations that are not adequately covered by this Specification.

It is essential that the Engineer of Record take all necessary precautions to ensure that the structure does not fail catastrophically during testing. A careful assessment of structural conditions before testing is a fundamental requirement. This includes accurate measurement and characterization of the size and strength of members, connections, and details. All safety regulations of OSHA and other pertinent bodies must be strictly adhered to. Shoring and scaffolding should be used as required in the proximity of the test area to mitigate against unexpected circumstances. Deformations must be carefully monitored and structural conditions must be continually evaluated. In some cases it may be desirable to monitor strains as well.

The Engineer of Record must use judgement to determine when deflections are becoming excessive and terminate the tests at a safe level even if the desired loading has not been achieved. Incremental loading is specified so that deformations can be accurately monitored and the performance of the structure carefully observed. Load increments should be small enough initially so that the onset of significant yielding can be determined. The increment can be reduced as the level of inelastic behavior increases, and the behavior at this level carefully evaluated to determine when to safely terminate the test. Periodic unloading after the onset of inelastic behavior will help the Engineer of Record determine when to terminate the test to avoid excessive permanent deformation or catastrophic failure.

*It must be recognized that the margin of safety at the maximum load level used in the test may be very small, depending on such factors as the original design, the purpose of the tests, and the condition of the structure. Thus, it is imperative that all appropriate safety measures be adopted. It is recommended that the maximum live load used for load tests be selected conservatively. It should be noted that experience in testing more than one bay of a structure is limited.*

Criteria limiting increases in deformations for a period of one hour have been given to ensure that the structure is stable at the loads evaluated.

A detailed discussion of reliability-based condition assessment of existing structures has been provided by Ellingwood (1996).

## **2. Serviceability Evaluation**

In certain cases serviceability criteria must be determined by load testing. It should be recognized that complete recovery (i.e., return to initial deflected shape) after removal of maximum load is unlikely because of phenomena such as local yielding, slip at the slab interface in composite construction, creep in concrete slabs, localized crushing or deformation at shear connections in slabs, slip in bolted connections, and effects of continuity. Because most structures exhibit some slack when load is first applied, it is appropriate to project the load-deformation curve back to zero load to determine the slack and exclude it from the recorded deformations. Where desirable, the applied load sequence can be repeated to demonstrate that the structure is essentially elastic under service loads and that the permanent set is not detrimental.

## **N5. EVALUATION REPORT**

Extensive evaluation and load testing of existing structures is often performed when appropriate documentation no longer exists or when there is considerable disagreement about the condition of a structure. The resulting evaluation is only effective if well documented, particularly when load testing is involved. Furthermore, as time passes, various interpretations of the results can arise unless all parameters of the structural performance, including material properties, strength, and stiffness, are well documented.

## APPENDIX B

### DESIGN REQUIREMENTS

#### B5. LOCAL BUCKLING

##### 1. Classification of Steel Sections

The limiting width-thickness  $\lambda_p$  and  $\lambda_r$  ratios for webs in pure flexure ( $P_u/\phi_b P_y = 0$ ) and with axial compression have been revised in terms of  $(h/t)$  rather than  $(h_c/t)$ . The simplified formulation in Table B5.1 for  $\lambda_r$  based on double symmetry with equal flanges ( $h/h_c = 1$ ) is unconservative when the compression flange is smaller than the tension flange, and conservative if the reverse is true. The more accurate limit is given in Appendix B5.1 as a function of  $h_c$ . Figure C-A-B5.1 illustrates the  $\lambda_r$  variation for axial compression and flange asymmetry effects.

The  $3/4$  minimum and  $3/2$  maximum restrictions on  $h/h_c$  in Equations A-B5-1 and A-B5-2 approximately correspond to the 0.1 and 0.9 range of  $I_{yc}/I_y$  for a member to be considered a singly symmetric I shape. Otherwise, when the flange areas differ by more than a factor of two, the member should be conservatively designed as a tee section.

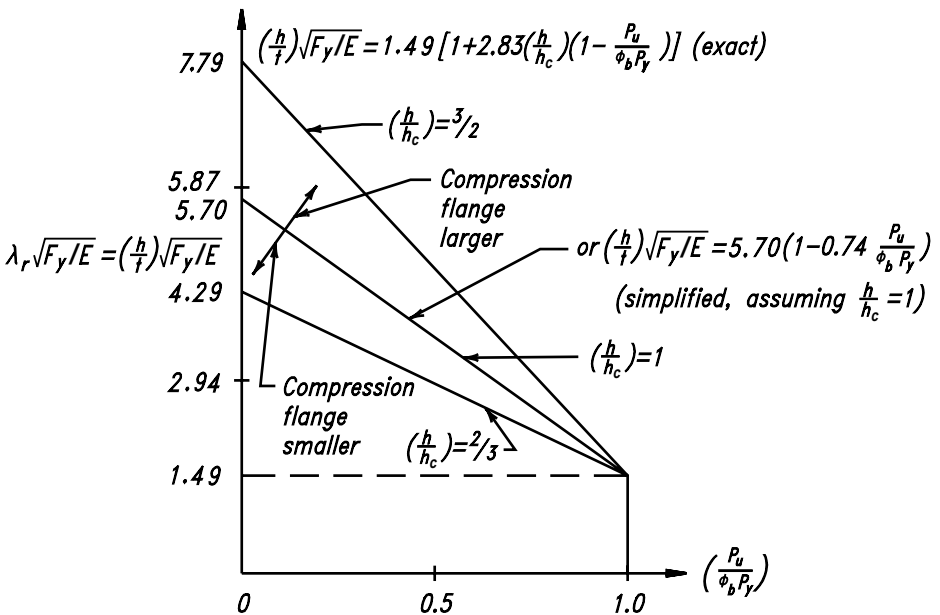

Fig. C-A-B5.1. Web local buckling for I-shaped members.

## APPENDIX E

### COLUMNS AND OTHER COMPRESSION MEMBERS

#### E3. DESIGN COMPRESSIVE STRENGTH FOR FLEXURAL-TORSIONAL BUCKLING

The equations in Appendix E3 for determining the flexural-torsional elastic buckling loads of columns are derived in texts on structural stability (Timoshenko and Gere, 1961; Bleich, 1952; Galambos, 1968; and Chen and Atsuta, 1977, for example). Since these equations for flexural-torsional buckling apply only to elastic buckling, they must be modified for inelastic buckling when  $F_{cr} > 0.5F_y$ . This is accomplished through the use of the equivalent slenderness factor  $\lambda_e = \sqrt{F_y / F_e}$ .

## APPENDIX F

### BEAMS AND OTHER FLEXURAL MEMBERS

#### F1. DESIGN FOR FLEXURE

Three limit states must be investigated to determine the moment capacity of flexural members: lateral-torsional buckling (LTB), local buckling of the compression flange (FLB), and local buckling of the web (WLB). These limit states depend, respectively, on the beam slenderness ratio  $L_b/r_y$ , the width-thickness ratio  $b/t$  of the compression flange and the width-thickness ratio  $h/t_w$  of the web. For convenience, all three measures of slenderness are denoted by  $\lambda$ .

Variations in  $M_n$  with  $L_b$  are shown in Figure C-F1.1. The discussion of plastic, inelastic, and elastic buckling in Commentary Section F1 with reference to lateral-torsional buckling applies here except for an important difference in the significance of  $\lambda_p$  for lateral-torsional buckling and local buckling. Values of  $\lambda_p$  for FLB and WLB produce a compact section with a rotation capacity of about three (after reaching  $M_p$ ) before the onset of local buckling, and therefore meet the requirements for plastic analysis of load effects (Commentary Section B5). On the other hand, values of  $\lambda_p$  for LTB do not allow plastic analysis because they do not provide rotation capacity beyond that needed to develop  $M_p$ . Instead  $L_b \leq L_{pd}$  (Section F1.3) must be satisfied.

Analyses to include restraint effects of adjoining elements are discussed in Galambos (1998). Analysis of the lateral stability of members with shapes not covered in this appendix must be performed according to the available literature (Galambos, 1998).

See the Commentary for Section B5 for the discussion of the equation regarding the bending capacity of circular sections.

#### F3. WEB-TAPERED MEMBERS

##### 1. General Requirements

The provision contained in Appendix F3 covers only those aspects of the design of tapered members that are unique to tapered members. For other criteria of design not specifically covered in Appendix F3, see the appropriate portions of this Specification and Commentary.

The design of wide-flange columns with a single web taper and constant flanges follows the same procedure as for uniform columns according to Section E2, except the column slenderness parameter  $\lambda_c$  for major axis buckling is determined for a slenderness ratio  $K_y L / r_{ox}$ , and for minor axis buckling for  $KL / r_{oy}$ , where  $K_y$  is an effective length factor for tapered members,  $K$  is the effective length factor for pris-

matic members, and  $r_{ox}$  and  $r_{oy}$  are the radii of gyration about the x and the y axes, respectively, taken at the smaller end of the tapered member.

For stepped columns or columns with other than a single web taper, the elastic critical stress is determined by analysis or from data in reference texts or research reports (Chapters 11 and 13 in Timoshenko and Gere (1961), Bleich (1952), and Kitipornchai and Trahair (1980)), and then the same procedure of using  $\lambda_{eff}$  is utilized in calculating the factored resistance.

This same approach is recommended for open section built-up columns (columns with perforated cover plates, lacing, and battens) where the elastic critical buckling stress determination must include a reduction for the effect of shear. Methods for calculating the elastic buckling strength of such columns are given in Chapter 12 of the SSRC Guide (Galambos, 1998) and in Timoshenko and Gere (1961) and Bleich (1952).

### 3. Design Compressive Strength

The approach in formulating  $F_{cr}$  of tapered columns is based on the concept that the critical stress for an axially loaded tapered column is equal to that of a prismatic column of different length, but of the same cross section as the smaller end of the tapered column. This has resulted in an equivalent effective length factor  $K_\gamma$  for a tapered member subjected to axial compression (Lee, Morrell, and Ketter, 1972). This factor, which is used to determine the value of  $S$  in Equations A-F3-2 and  $\lambda_c$  in Equation E2-3, can be determined accurately for a symmetrical rectangular rigid frame comprised of prismatic beams and tapered columns.

With modifying assumptions, such a frame can be used as a mathematical model to determine with sufficient accuracy the influence of the stiffness  $\Sigma(I/b)_g$  of beams and rafters which afford restraint at the ends of a tapered column in other cases such as those shown in Figure C-A-F3.3. From Equations A-F3-2 and E2-3, the critical load  $P_{cr}$  can be expressed as  $\pi^2 EI_o / (K_\gamma l)^2$ . The value of  $K_\gamma$  can be obtained by interpolation, using the appropriate chart from Lee et al. (1972) and restraint modifiers  $G_T$  and  $G_B$ . In each of these modifiers the tapered column, treated as a prismatic member having a moment of inertia  $I_o$ , computed at the smaller end, and its actual length

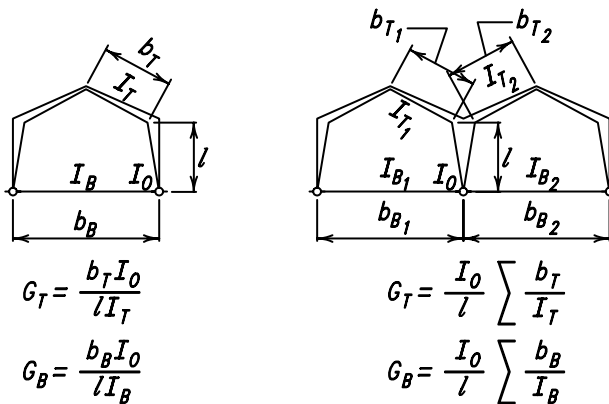

Fig. C-A-F3.3. Restraint modifiers for tapered columns.

$l$ , is assigned the stiffness  $I_o/l$ , which is then divided by the stiffness of the restraining members at the end of the tapered column under consideration.

#### 4. Design Flexural Strength

The development of the design bending stress for tapered beams follows closely with that for prismatic beams. The basic concept is to replace a tapered beam by an equivalent prismatic beam with a different length, but with a cross section identical to that of the smaller end of the tapered beam (Lee et al., 1972). This has led to the modified length factors  $h_s$  and  $h_w$  in Equations A-F3-6 and A-F3-7.

Equations A-F3-6 and A-F3-7 are based on total resistance to lateral buckling, using both St. Venant and warping resistance. The factor  $B$  modifies the basic  $F_{by}$  to members which are continuous past lateral supports. Categories a, b, and c of Appendix F3.4 usually apply; however, it is to be noted that they apply only when the axial force is small and adjacent unbraced segments are approximately equal in length. For a single member, or segments which do not fall into category a, b, c, or d, the recommended value of  $B$  is unity. The value of  $B$  should also be taken as unity when computing the value of  $F_{by}$  to obtain  $M_n$  to be used in Equations H1-1 and C1-1, since the effect of moment gradient is provided for by the factor  $C_m$ . The background material is given in WRC Bulletin No. 192 (Morrell and Lee, 1974).

## APPENDIX G

### PLATE GIRDERS

Appendix G is taken from AISI Bulletin 27 (Galambos, 1978). Comparable provisions are included in the AISC ASD Specification. The provisions are presented in an appendix as they are seldom used and produce designs which are often less economical than plate girders designed without tension-field action.

The web slenderness ratio  $h / t_w = 5.70\sqrt{E / F_{yf}}$  that distinguishes plate girders from beams is written in terms of the flange yield stress, because for hybrid girders inelastic buckling of the web due to bending depends on the flange strain.

The equation for  $R_e$  used in the 1986 LRFD Specification was the same as that used in the AASHTO *Standard Specification for Highway Bridges*. In this edition, the equation for  $R_e$ , used in the AISC ASD Specification since 1969, is used because its derivation is published (Gaylord, Gaylord, and Stallmeyer, 1992 and Joint ASCE-AASHTO Committee on Flexural Members, 1968) and it is more accurate than the AASHTO equation.

#### G2. DESIGN FLEXURAL STRENGTH

In previous versions of the AISC Specification a coefficient of  $0.0005a_r$  was used in  $R_{PG}$  based on the work of Basler (1961). This value is valid for  $a_r \leq 2$ . In that same paper, Basler developed a more general coefficient, applicable to all ratios of  $A_w/A_f$  which has been adopted because application of the previous equation to sections with large  $a_r$  values gives unreasonable results. An arbitrary limit of  $a_r \leq 10$  is imposed so that the  $R_{PG}$  expression is not applied to sections approaching a tee shape.



## APPENDIX H

### MEMBERS UNDER COMBINED FORCES AND TORSION

#### H3. ALTERNATIVE INTERACTION EQUATIONS FOR MEMBERS UNDER COMBINED STRESS

In the case of members not subject to flexural buckling, i.e.,  $L_b < L_{pd}$ , the use of somewhat more liberal interaction Equations A-H3-5 and A-H3-6 is acceptable as an alternative when the flexure is about one axis only.

The alternative interaction Equations A-H3-1 and A-H3-2 for H and wide-flange column shapes were taken from Galambos (1998), Springfield (1975), and Tebedge and Chen (1974).

For I-shaped members with  $b_f/d > 1.0$ , use of Section H1 is recommended, because no additional research is available for this case.

## APPENDIX J

### CONNECTIONS, JOINTS, AND FASTENERS

#### J2. WELDS

##### 4. Design Strength

When weld groups are loaded in shear by an external load that does not act through the center of gravity of the group, the load is eccentric and will tend to cause a relative rotation and translation between the parts connected by the weld. The point about which rotation tends to take place is called the instantaneous center of rotation. Its location is dependent upon the load eccentricity, geometry of the weld group, and deformation of the weld at different angles of the resultant elemental force relative to the weld axis.

The individual resistance force of each unit weld element can be assumed to act on a line perpendicular to a ray passing through the instantaneous center and that element's location (see Figure C-A-J2.1).

The ultimate shear strength of weld groups can be obtained from the load deformation relationship of a single-unit weld element. This relationship was originally given by Butler et al. (1972) for E60 (E43) electrodes. Curves for E70 (E48) electrodes used in the Appendix were obtained by Lesik and Kennedy (1990).

Unlike the load-deformation relationship for bolts, strength and deformation performance in welds are dependent on the angle that the resultant elemental force makes with the axis of the weld element (see Figure C-A-J2.1). The actual load deformation relationship for welds is given in Figure C-A-J2.2, taken from Lesik

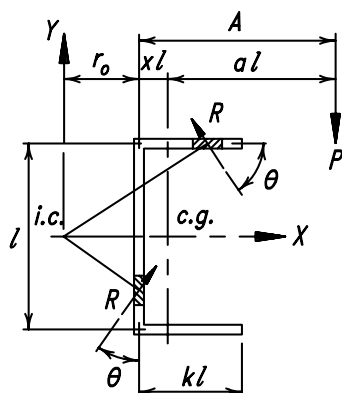

Fig. C-A-J2.1. Weld element nomenclature.

and Kennedy (1990). Conversion of the SI equation to foot-pound units results in the following weld strength equation for  $R_n$ :

$$R_n = 0.852(1.0 + 0.50 \sin^{1.5} \theta) F_{EXX} A_w$$

Because the maximum strength is limited to  $0.60F_{EXX}$  for longitudinally loaded welds ( $\theta = 0^\circ$ ), the LRFD Specification provision provides, in the reduced equation coefficient, a reasonable margin for any variation in welding techniques and procedures. To eliminate possible computational difficulties, the maximum deformation in the weld elements is limited to  $0.17w$ . For design convenience, a simple elliptical formula is used for  $f(p)$  to closely approximate the empirically derived polynomial in Lesik and Kennedy (1990).

The total resistance of all the weld elements combine to resist the eccentric ultimate load, and when the correct location of the instantaneous center has been selected, the three in-plane equations of statics ( $\Sigma F_x, \Sigma F_y, \Sigma M$ ) will be satisfied. Numerical techniques, such as those given by Brandt (1982), have been developed to locate the instantaneous center of rotation subject to convergent tolerances. Earlier editions of the AISC *Manual of Steel Construction* (AISC, 1980, 1986a, 1989) took advantage of the inelastic redistribution of stresses that is inherent in the Appendix J2.4 procedure. However, in each of the utilized computational techniques the resulting coefficients were factored down so that the maximum stress, at any point in the weld group, did not exceed the limiting value specified by either the Allowable Stress Design or LRFD Specifications,  $0.3F_u$  or  $0.6F_u$ , respectively. As a result, the tabulated weld-capacity data shown in the appropriate referenced manual tables will be

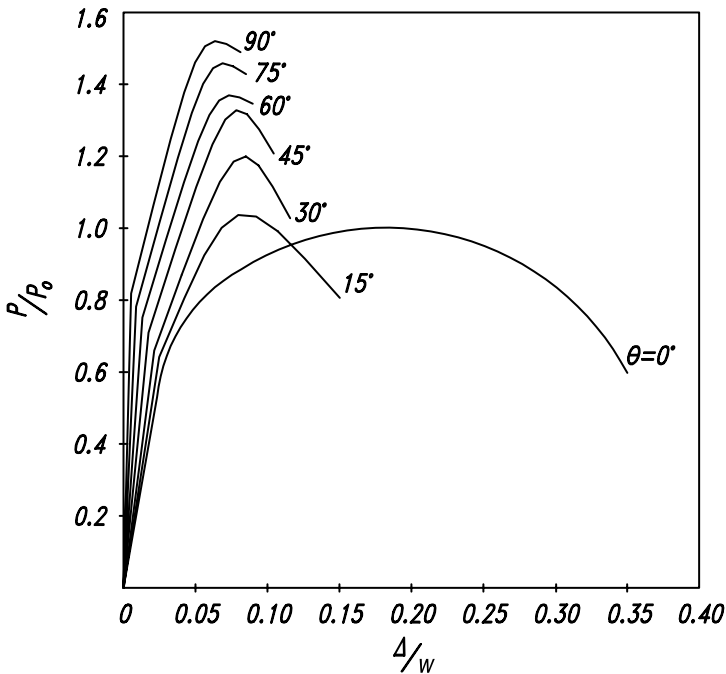

Fig. C-A-J2.2. Load deformation relationship.

found to be conservative relative to the data obtained using the computational procedure presented in Appendix J2.4.

## APPENDIX K

### CONCENTRATED FORCES, PONDING, AND FATIGUE

#### K3. DESIGN FOR CYCLIC LOADING (FATIGUE)

Because most members in building frames are not subject to a large enough number of cycles of full design stress application to require design for fatigue, the provisions covering such designs have been placed in Appendix K3.

When fatigue is a design consideration, its severity is most significantly affected by the number of load applications, the magnitude of the stress range, and the severity of the stress concentrations associated with the particular details. These factors are not encountered in normal building designs; however, when encountered and when fatigue is of concern, all provisions of Appendix K3 must be satisfied.

In general, members or connections subject to less than a few thousand cycles of loading will not constitute a fatigue condition except possibly for cases involving full reversal of loading and particularly sensitive categories of details. This is because the admissible static design stress range will be limited by the admissible static design stress. At low levels of cyclic tensile stress, a point is reached where the stress range is so low that fatigue cracking will not initiate regardless of the number of cycles of loading. This level of stress is defined as the fatigue threshold,  $F_{TH}$ .

Fluctuation in stress which does not involve tensile stress does not cause crack propagation and is not considered to be a fatigue situation. On the other hand, in elements of members subject solely to calculated compressive stress, fatigue cracks may initiate in regions of high tensile residual stress. In such situations, the cracks generally do not propagate beyond the region of the residual tensile stress, because the residual stress is relieved by the crack. For this reason, stress ranges that are completely in compression need not be investigated for fatigue. For cases involving cyclic reversal of stress the calculated stress range must be taken as the sum of the compressive stress and the tensile stress caused by different direction or pattern of applied live load.

When fabrication details involving more than one category occur at the same location in a member, the stress range at that location must be limited to that of the most restrictive category. By locating notch-producing fabrication details in regions subject to a small range of stress, the need for a member larger than required by static loading will often be eliminated.

Extensive test programs (Fisher, Frank, Hirt, and McNamee, 1970, and Fisher, Albrecht, Yen, and Klingerman, 1974) using full size specimens, substantiated by theoretical stress analysis, have confirmed the following general conclusions:

- (1) Stress range and notch severity are the dominant stress variables for welded details and beams.
- (2) Other variables such as minimum stress, mean stress, and maximum stress are not significant for design purposes.
- (3) Structural steels with yield points of 36 (250) to 100 ksi (690 MPa) do not exhibit significantly different fatigue strength for given welded details fabricated in the same manner.

Because the design stress range may be readily calculated from the equation for the mean curve minus two standard deviations of the actual test data using modern hand calculators or computers, the past method which relied upon multiple tables of cycles of loading, stress categories, design stress ranges, and illustrative examples has been replaced by a single table (Table A-K3.1). In the new format, the situation description, the stress category, the ingredients for the applicable equation, instructive information and pertinent illustrative examples are presented in separate cells across individual table rows. The sites of concern for potential crack initiation are present in text and in example sketches. Similar format and consistent criteria is being developed for the AWS Code and other Specifications.

A detail not covered by earlier editions of the Specification has been added (Frank and Fisher, 1979) to cover tension-loaded plate elements connected at their end by transverse groove or fillet welds in which there is more than a single site for the initiation of fatigue cracking, one of which will be more critical than the others depending upon welded joint type and size and material thickness. Regardless of the site within the joint at which potential crack initiation is considered, the design stress range provided is applicable to connected material at the toe of the weld.

The fatigue resistance of bolts subject to tension is predictable in the absence of pretension and prying action; and in this edition of the specification criteria are provided for such non-pretensioned details as hanger rods and anchor rods. In the case of pretensioned bolts, deformation of the connected parts through which pretension is applied introduces prying action, the magnitude of which is not completely predictable (Kulak et al., 1987). The effects of prying are not limited to a change in the average axial tension on the bolt but includes bending in the threaded area under the nut. Because of the uncertainties, definitive criteria for calculating prying effects and definitive criteria for design stress range are not included in the specification. To limit the uncertainties regarding prying action on the fatigue of pretensioned bolts in details which introduce prying, the design stress range provided in Table A-K3.1 is appropriate for extended cyclic loading only if the prying included in the applied load is small.

Non-pretensioned fasteners are not permitted under the Specification for joints subject to cyclic shear forces. Bolts installed in joints meeting all the requirements for slip-critical connections survive unharmed when subject to cyclic shear stresses sufficient to fracture the connected parts, for which criteria are provided in Section 2 of Table A-K3.1.



# References

- Ackroyd, M. H., and Gerstle, K. H. (1982), "Behavior of Type 2 Steel Frames," *Journal of the Structural Division*, ASCE, Vol. 108, No. ST7, July, pp. 1541-1556.
- Ad Hoc Committee on Serviceability Research (1986), "Structural Serviceability: A Critical Appraisal and Research Needs," *Journal of Structural Engineering*, ASCE, Vol. 112, No. 12, pp. 2646-2664.
- American Association of State Highway and Transportation Officials (AASHTO) (1996), *Load and Resistance Factor Design Specification for Highway Bridges*, Washington, D.C.
- American Concrete Institute (ACI) (1999), *Building Code Requirements for Structural Concrete*, ACI 318-99, Detroit, MI.
- American Concrete Institute (ACI) (1999a), *Building Code Requirements for Structural Concrete*, ACI 318M-99, Detroit, MI.
- American Institute of Steel Construction, Inc. (AISC) (1973), "Commentary on Highly Restrained Welded Connections," *Engineering Journal*, AISC, Vol. 10, No. 3, 3<sup>rd</sup> Quarter, pp. 61-73.
- American Institute of Steel Construction, Inc. (AISC) (1978), *Specification for the Design, Fabrication, and Erection of Structural Steel for Buildings*, Chicago, IL.
- American Institute of Steel Construction, Inc. (AISC) (1980), *Manual of Steel Construction*, Chicago, IL.
- American Institute of Steel Construction, Inc. (AISC) (1986), *Load and Resistance Factor Design Specification for Structural Steel Buildings*, Chicago, IL.
- American Institute of Steel Construction, Inc. (AISC) (1986a), *Load and Resistance Factor Design Manual of Steel Construction*, Chicago, IL.
- American Institute of Steel Construction, Inc. (AISC) (1989), *Specification for Structural Steel Buildings—Allowable Stress Design and Plastic Design*, Chicago, IL.
- American Institute of Steel Construction, Inc. (AISC) (1989a), *Allowable Stress Design Manual of Steel Construction*, Chicago, IL.
- American Institute of Steel Construction, Inc. (AISC) (1997), *Seismic Provisions for Structural Steel Buildings*, Chicago, IL.
- American Institute of Steel Construction, Inc. (AISC) (1997a), "k-area Advisory Statement," *Modern Steel Construction*, February.
- American Institute of Steel Construction, Inc. (AISC) (1999), *Seismic Provisions for Structural Steel Buildings Supplement No. 1*, Chicago, IL.



- American Petroleum Institute (API) (1993), *Recommended Practice for Planning, Designing and Constructing Fixed Offshore Platforms—Load and Resistance Factor Design*, First Edition, July 1, 1993, Washington, D.C.
- American Society of Civil Engineers (ASCE) (1979), *Structural Design of Tall Steel Buildings*, New York, NY.
- American Society of Civil Engineers (ASCE) (1998), *Minimum Design Loads for Buildings and Other Structures*, ASCE7-98, New York, NY.
- Ang, K. M., and Morris, G. A. (1984), "Analysis of Three-Dimensional Frames with Flexible Beam-Column Connections," *Canadian Journal of Civil Engineering*, Vol. 11, No. 2, pp. 245-254.
- ASCE Task Committee on Design Criteria for Composite Structures in Steel and Concrete (1992), "Proposed Specification for Structural Steel Beams with Web Openings," Darwin, D., Chmn., *Journal of Structural Engineering*, ASCE, Vol. 118, No. ST12, December, pp. 3315-3324.
- ASCE Task Committee on Design Criteria for Composite Structures in Steel and Concrete (1992a), "Commentary on Proposed Specification for Structural Steel Beams with Web Openings," Darwin, D., Chmn., *Journal of Structural Engineering*, ASCE, Vol. 118, No. ST12, December, pp. 3325-3349.
- ASCE Task Committee on Effective Length (1997), *Effective Length and Notional Load Approaches for Assessing Frame Stability: Implications for American Steel Design*, ASCE, Reston, VA.
- Joint ASCE-AASHTO Committee on Flexural Members (1968), "Design of Hybrid Steel Beams," Report of Subcommittee 1, *Journal of the Structural Division*, ASCE, Vol. 94, No. ST6, June, pp. 1397-1426.
- Aslani, F., and Goel, S. C. (1991), "An Analytical Criteria for Buckling Strength of Built-Up Compression Members," *Engineering Journal*, AISC, Vol. 28, No. 4, 4th Quarter, pp. 159-168.
- ATC (1978), *Tentative Provisions for the Development of Seismic Regulations for Buildings*, ATC Publication 3-06, June.
- Austin, W. J. (1961), "Strength and Design of Metal Beam-Columns," *Journal of the Structural Division*, ASCE, Vol. 87, No. ST4, April, pp. 1-32.
- Basler, K. (1961), "Strength of Plate Girders in Shear," *Journal of the Structural Division*, ASCE, Vol. 104, No. ST9, October, pp. 151-180.
- Bendigo, R. A., Hansen, R. M., and Rumpf, J. L. (1963), "Long Bolted Joints," *Journal of the Structural Division*, ASCE, Vol. 89, No. ST6, December, pp. 187-213.
- Bergfelt, A. (1971), *Studies and Tests on Slender Plate Girders Without Stiffeners*, March.
- Bigos, J., Smith, G. W., Ball, E. F., and Foehl, P. J. (1954), "Shop Paint and Painting Practice," *Proceedings of AISC National Engineering Conference*, Milwaukee, WI.
- Birkemoe, P. C., and Gilmor, M. I. (1978), "Behavior of Bearing-Critical Double-Angle Beam Connections," *Engineering Journal*, AISC, Vol. 15, No. 4, 4th Quarter, pp. 109-115.

- Bjorhovde, R. (1972), *Deterministic and Probabilistic Approaches to the Strength of Steel Columns*, Ph.D. Dissertation, Lehigh University, Bethlehem, PA, May.
- Bjorhovde, R. (1988), "Columns: From Theory to Practice," *Engineering Journal*, AISC, Vol. 25, No. 1, 1st Quarter, pp. 21-34.
- Bjorhovde, R., Brozzetti, J., and Colson, A. (Eds.) (1988), *Connections in Steel Structures: Behaviour, Strength and Design*, Elsevier Applied Science, London, England.
- Bjorhovde, R., Colson, A., and Brozzetti, J. (1990), "Classification System for Beam-to-Column Connections," *Journal of Structural Engineering*, ASCE, Vol. 116, No. 11, pp. 3059-3076.
- Bjorhovde, R., Colson, A., Haaijer, G., and Stark, J. W. B. (Eds.) (1992), *Connections in Steel Structures II: Behavior, Strength and Design*, AISC, Chicago, IL.
- Bjorhovde, R., Colson, A., and Zandonini, R. (Eds.) (1996), *Connections in Steel Structures III: Behaviour, Strength and Design*, Pergamon Press, London, England.
- Bleich, F. (1952), *Buckling Strength of Metal Structures*, McGraw-Hill Book Co., New York, NY.
- Brandt, G. D. (1982), "A General Solution for Eccentric Loads on Weld Groups," *Engineering Journal*, AISC, Vol. 19, No. 3, 3rd Quarter, pp.150-159.
- Branson, D. E. (1964), "Time-Dependent Effects in Composite Concrete Beams," *Journal of the American Concrete Institute*, Vol. 61, February.
- Bridge, P. Q., and Roderick, J. W. (1978), "Behavior of Built-Up Composite Columns," *Journal of the Structural Division*, ASCE, Vol. 104, No. ST7, July, pp. 1141- 1165.
- Brockenbrough, R. L. (1983), "Considerations in the Design of Bolted Joints for Weathering Steel," *Engineering Journal*, AISC, Vol. 20, No. 1, 1st Quarter, pp. 40-45.
- Butler, L. J., Pal, S., and Kulak, G. L. (1972), "Eccentrically Loaded Welded Connections," *Journal of the Structural Division*, ASCE, Vol. 98, No. ST5, May, pp. 989-1005.
- Canadian Standards Association (1989), *Limit States Design of Steel Structures*, Appendices G, H, and I, CSA S16.1-M89, Rexdale, Ontario, Canada.
- Carter, C. J., Tide, R. H. R., and Yura, J. A. (1997), "A Summary of Changes and Derivation of LRFD Bolt Design Provisions," *Engineering Journal*, AISC, Vol. 34, No. 3, 3<sup>rd</sup> Quarter, pp.75-81.
- Carter, C. J. (1999), *Stiffening of Wide-Flange Columns at Moment Connections: Wind and Seismic Applications*, Steel Design Guide Series No. 13, AISC, Chicago, IL.
- Chen, S., and Tong, G. (1994), "Design for Stability: Correct Use of Braces," *Steel Structures, J. Singapore Struct. Steel Soc.*, Vol. 5, No.1, Dec., pp. 15-23.
- Chen, W. F., and Atsuta, T. (1977), *Theory of Beam Columns, Volume II: Space Behavior and Design*, McGraw-Hill, New York, NY.
- Chen, W. F., Goto, Y., and Liew, J. Y. R. (1995), *Stability Design of Semi-Rigid Frames*, John Wiley and Sons, New York, NY.
- Chen, W. F., and Lui, E. M. (1991), *Stability Design of Steel Frames*, CRC Press, Boca Raton, FL.

- Chen, W. F., and Toma, S. (1994), *Advanced Analysis of Steel Frames*, CRC Press, Boca Raton, FL.
- Chien, E. Y. L., and Ritchie, J. K. (1984), *Composite Floor Systems*, Canadian Institute of Steel Construction, Willowdale, Ontario, Canada.
- Chopra, A. K., and Newmark, N. M. (1980), *Design of Earthquake Resistant Structures*, John Wiley and Sons, Inc., New York, NY.
- Cooper, P. B., Galambos, T. V., and Ravindra, M. K. (1978), "LRFD Criteria for Plate Girders," *Journal of the Structural Division*, ASCE, Vol. 104, No. ST9, September, pp. 1389-1407.
- Darwin, D. (1990), *Steel and Composite Beams with Web Openings*, AISC Steel Design Guide Series No. 2, AISC, Chicago, IL.
- DeWolf, J. T. and Ricker, D. T. (1990), *Column Base Plates*, Steel Design Guide Series No. 1, AISC, Chicago, IL.
- Disque, R. O. (1964), "Wind Connections with Simple Framing," *Engineering Journal*, AISC, Vol. 1, No. 3, July, pp. 101-103.
- Disque, R. O. (1973), "Inelastic K-Factor in Design," *Engineering Journal*, AISC, Vol. 10, No. 2, 2<sup>nd</sup> Quarter, pp. 33-35.
- Easterling, W. S., Gibbings, D. R., and Murray, T. M. (1993), "Strength of Shear Studs in Steel Deck on Composite Beams and Joists," *Engineering Journal*, AISC, Vol. 30, No. 2, 2<sup>nd</sup> Quarter, pp. 44-55.
- Easterling, W. S., and Gonzales, L. (1993), "Shear Lag Effects in Steel Tension Members," *Engineering Journal*, AISC, Vol. 30, No. 3, 3rd Quarter, pp. 77-89.
- Elgaaly, M. (1983), "Web Design Under Compressive Edge Loads," *Engineering Journal*, AISC, Vol. 20, No. 4, 4th Quarter, pp. 153-171.
- Elgaaly, M., and Salkar, R. (1991), "Web Crippling Under Edge Loading," *Proceedings of AISC National Steel Construction Conference*, Washington, D.C.
- Ellifritt, D. S., Wine, G., Sputo, T., and Samuel, S. (1992), "Flexural Strength of WT Sections," *Engineering Journal*, AISC, Vol. 29, No. 2, 2nd Quarter, pp. 67-74.
- Ellingwood, B. E., MacGregor, J. G., Galambos, T. V., and Cornell, C. A. (1982), "Probability-Based Load Criteria: Load Factors and Load Combinations," *Journal of the Structural Division*, ASCE, Vol. 108, No. 5, pp. 978-997.
- Eurocode 3 (1992), *Design of Steel Structures, Part 1: General Rules and Rules for Buildings*, ENV 1993-1-1:1992, Comite European de Normalisation (CEN), Brussels, Belgium.
- Federal Emergency Management Agency (FEMA) (1995), *Interim Guidelines: Evaluation, Repair, Modification and Design of Welded Steel Moment Frame Structures*, Bulletin No. 267, FEMA, Washington, D.C.
- Federal Emergency Management Agency (FEMA) (1997), *Seismic Performance of Bolted and Riveted Connections* in "Background Reports; Metallurgy, Fracture Mechanics, Welding, Moment Connections and Frame Systems Behavior, Bulletin No. 288, FEMA, Washington, D.C.

- Fielding, D. J., and Huang, J. S. (1971), "Shear in Steel Beam-to-Column Connections," *Welding Journal*, AWS, Vol. 50, No. 7, Research Supplement, pp. 313–326.
- Fielding, D. J., and Chen, W. F. (1973), "Steel Frame Analysis and Connection Shear Deformation," *Journal of the Structural Division*, ASCE, Vol. 99, No. ST1, January, pp. 1-18.
- Fisher, J. M., and West, M. A. (1990), *Serviceability Design Considerations for Low-Rise Buildings*, Steel Design Guide Series No. 3, AISC, Chicago, IL.
- Fisher, J. M., and West, M. A. (1997), *Erection Bracing of Low-Rise Structural Steel Buildings*, Steel Design Guide Series No. 10, AISC, Chicago, IL.
- Fisher, J. W., Albrecht, P. A., Yen, B. T., Klingerman, D. J., and McNamee, B. M. (1974), *Fatigue Strength of Steel Beams With Welded Stiffeners and Attachments*, National Cooperative Highway Research Program, Report 147, Washington, D.C.
- Fisher, J. W., Frank, K. H., Hirt, M. A., and McNamee, B. M. (1970), *Effect of Weldments on the Fatigue Strength of Beams*, National Cooperative Highway Research Program, Report 102, Washington, D.C.
- Fisher, J. W., Galambos, T. V., Kulak, G. L., and Ravindra, M. K. (1978), "Load and Resistance Factor Design Criteria for Connectors," *Journal of the Structural Division*, ASCE, Vol. 104, No. ST9, September, pp. 1427-1441.
- Frank, K. H., and Fisher, J. W. (1979), "Fatigue Strength of Fillet Welded Cruciform Joints," *Journal of the Structural Division*, ASCE, Vol. 105, No. ST9, September.
- Frank, K. H., and Yura, J. A. (1981), *An Experimental Study of Bolted Shear Connections*, FHWA/RD-81/148, Washington, D.C., December.
- Freeman, F. R. (1930), *The Strength of Arc-Welded Joints*, Proc. Inst. Civil Engineers, Vol. 231, London, England.
- Galambos, T. V. (1960), "Influence of Partial Base Fixity on Frame Stability," *Journal of the Structural Division*, ASCE, Vol. 86, No. ST5, May.
- Galambos, T. V. (1961), Discussion of "Strength and Design of Metal Beam-Columns" by W. J. Austin, *Journal of the Structural Division*, ASCE, Vol 87, No. ST8, p. 247.
- Galambos, T. V. (1968), *Structural Members and Frames*, Prentice-Hall, Englewood Cliffs, NJ.
- Galambos, T. V. (1976), *Proposed Criteria for Load Resistance Factor Design of Steel Building Structures*, Research Report No. 45, Civil Engineering Dept., Washington University, St. Louis, MO, May.
- Galambos, T. V. (1978), *Bulletin No. 27*, American Iron and Steel Institute, Washington, D.C., January.
- Galambos, T. V. (1991), "Design of Axially Loaded Compressed Angles," *Proceedings 1991 Annual Technical Session*, Structural Stability Research Council, Chicago, IL, pp. 353-367.
- Galambos, T. V. (ed.) (1998), *Guide to Stability Design Criteria for Metal Structures*, Structural Stability Research Council, 5th Edition, John Wiley & Sons, New York, NY.

- Galambos, T. V., and Chapuis, J. (1980), *LRFD Criteria for Composite Columns and Beam-Columns*, Revised Draft, Washington University, Dept. of Civil Engineering, St. Louis, MO, December.
- Galambos, T. V., Ellingwood, B., MacGregor, J. G., and Cornell, C. A. (1982), "Probability-Based Load Criteria: Assessment of Current Design Practice," *Journal of the Structural Division*, ASCE, Vol. 108, No. ST5, May, pp. 959-977.
- Galambos, T. V., and Ravindra, M. K. (1978), "Properties of Steel for Use in LRFD," *Journal of the Structural Division*, ASCE, Vol. 104, No. ST9, September, pp. 1459-1468.
- Gaylord, E. H. Jr., Gaylord, C. N., and Stallmeyer, J. E. (1992), *Design of Steel Structures*, 3rd Edition, McGraw-Hill Book Co., New York, NY.
- Geschwindner, L. F. (1994) "A Practical Approach to the Leaning Column," *Engineering Journal*, AISC, Vol. 31, No. 4, 4<sup>th</sup> Quarter, pp. 141-149.
- Gibson, G. T., and Wake, B. T. (1942), "An Investigation of Welded Connections for Angle Tension Members," *The Welding Journal*, American Welding Society, January, p. 44.
- Goble, G. G. (1968), "Shear Strength of Thin Flange Composite Specimens," *Engineering Journal*, AISC, Vol. 5., No. 2, 2nd Quarter, pp. 62-65.
- Goverdhan, A. V. (1983), *A Collection of Experimental Moment Rotation Curves: Evaluation of Predicting Equations for Semi-Rigid Connections*, M.S. Thesis, Vanderbilt University, Nashville, TN.
- Grant, J. A., Fisher, J. W., and Slutter, R. G. (1977), "Composite Beams with Formed Steel Deck," *Engineering Journal*, AISC, Vol. 14, No. 1, 1st Quarter, pp. 24-43.
- Griffis, L. G. (1992), *Load and Resistance Factor Design of W-Shapes Encased in Concrete*, Steel Design Guide Series No. 6, AISC, Chicago, IL.
- Hansell, W. C., Galambos, T. V., Ravindra, M. K., and Viest, I. M. (1978), "Composite Beam Criteria in LRFD," *Journal of the Structural Division*, ASCE, Vol. 104, No. ST9, September, pp. 1409-1426.
- Hardash, S. G., and Bjorhovde, R. (1985), "New Design Criteria for Gusset Plates in Tension," *Engineering Journal*, AISC, Vol. 22, No. 2, 2nd Quarter, pp. 77-94.
- Hoglund, T. (1971), *Simply Supported Long Thin Plate I-Girders Without Web Stiffeners, Subjected to Distributed Transverse Load*, Dept. of Building Statics and Structural Engineering of the Royal Institute of Technology, Stockholm, Sweden.
- Hsieh, S. H., and Deierlein, G. G. (1991), "Nonlinear Analysis of Three-Dimensional Steel Frames with Semi-Rigid Connections," *Computers and Structures*, Vol. 41, No 5, pp. 995-1009.
- International Association of Bridge and Structural Engineering (IABSE) (1968), *Final Report of the Eighth Congress*, Zurich, Switzerland, September.
- International Organization for Standardization (ISO) (1974), *Guide for the Evaluation of Human Exposure to Whole-Body Vibration*, Document ISO 2631, September.
- Iwankiw, N. (1984), "Note on Beam-Column Moment Amplification Factor," *Engineering Journal*, AISC, Vol. 21, No. 1, 1st Quarter, pp. 21-23.

- Johnson, D. L. (1985), "An Investigation into the Interaction of Flanges and Webs in Wide-Flange Shapes," *Proceedings 1985 Annual Technical Session*, Cleveland, OH, Structural Stability Research Council, Lehigh University, Bethlehem, PA.
- Johnson, D. L. (1996), *Final Report on Tee Stub Tests*, Butler Research Report, Grandview, MO, May.
- Johnston, B. G. (1939), *Pin-Connected Plate Links*, 1939 ASCE Transactions.
- Johnston, B. G., and Deits, G. R. (1942) "Tests of Miscellaneous Welded Building Connections," *Welding Journal*, American Welding Society, November, p. 5.
- Johnston, B. G., and Green, L. F. (1940), "Flexible Welded Angle Connections," *The Welding Journal*, American Welding Society, October.
- Jones, J. (1940), "Static Tests on Riveted Joints," *Civil Engineering*, ASCE, May.
- Kanchanalai, T. (1977), *The Design and Behavior of Beam-Columns in Unbraced Steel Frames*, AISI Project No. 189, Report No. 2, Civil Engineering/Structures Research Lab, University of Texas-Austin, TX, October.
- Kanchanalai, T., and Lu, L. W. (1979), "Analysis and Design of Framed Columns Under Minor Axis Bending," *Engineering Journal*, AISC, Vol. 16, No. 2, 2nd Quarter, pp. 29-41.
- Kemp, A. R., and Trinchero, P. E. (1997), "Horizontal Shear Failures Around Connectors Used With Steel Decking," *Composite Construction in Steel and Concrete III*, ASCE, pp. 104-118.
- Kenny, J. R., Bruce, D. A., and Bjorhovde, R. (1994), "Removal of Yield Stress Limitation for Composite Tubular Columns," *Engineering Journal*, AISC, Vol. 31, No. 1, pp. 1-11.
- Ketter, R. L. (1961), "Further Studies of the Strength of Beam-Columns," *Journal of the Structural Division*, ASCE, Vol. 87, No. ST6, August, pp. 135-152.
- Kim, H. J., and Yura, J. A. (1996), *The Effect of End Distance on the Bearing Strength of Bolted Connections*, PMFSEL Report No. 96-1, University of Texas-Austin.
- Kirby, P. A., and Nethercot, D. A. (1979), *Design for Structural Stability*, John Wiley and Sons, Inc., New York, NY.
- Kishi, N., and Chen, W. F. (1986), *Data Base of Steel Beam-to-Column Connections*, Vol. 1 & 2, Structural Engineering Report No. CE-STR-86-26, School of Civil Engineering, Purdue University, West Lafayette, IN.
- Kitipornchai, S., and Trahair, N. S. (1980), "Buckling Properties of Monosymmetric I-Beams," *Journal of the Structural Division*, ASCE, Vol. 109, No. ST5, May, pp. 941-957.
- Kloppel, K., and Seeger, T. (1964), "Dauerversuche Mit Einschnittigen Hv-Verbindungen Aus ST37," *Der Stahlbau*, Vol. 33, No. 8, August 1964, pp. 225-245 and Vol. 33, No. 11, November, pp. 335-346.
- Kulak, G. L., Fisher, J. W., and Struik, J. H. A. (1987), *Guide to Design Criteria for Bolted and Riveted Joints*, 2nd Edition, John Wiley & Sons, New York, NY.

- Lee, G. D., Morrell, M. L., and Ketter, R. L. (1972), "Design of Tapered Members," *WRC Bulletin*, No. 173, June.
- LeMessurier, W. J. (1976), "A Practical Method of Second Order Analysis, Part 1—Pin-Jointed Frames," *Engineering Journal*, AISC, Vol. 13, No. 4, 4th Quarter, pp. 89-96.
- LeMessurier, W. J. (1977), "A Practical Method of Second Order Analysis, Part 2—Rigid Frames," *Engineering Journal*, AISC, Vol. 14, No. 2, 2nd Quarter, pp. 49-67.
- Leon, R. T. (1994), "Composite Semi-Rigid Construction," *Engineering Journal*, AISC, Vol. 31, No. 2, pp. 57-67.
- Leon, R. T., Hoffman, J., and Staeger, T. (1996), *Design of Partially-Restrained Composite Connections*, Steel Design Guide Series No. 9, AISC, Chicago, IL.
- Lewis, B. E., and Zwerneman, F. J. (1996), *Edge Distance, Spacing, and Bearing in Bolted Connections*, Oklahoma State University, July.
- Lesik, D. F., and Kennedy, D. J. L. (1990), "Ultimate Strength of Fillet Welded Connections Loaded in Plane," *Canadian Journal of Civil Engineering*, National Research Council of Canada, Ottawa, Canada, Vol. 17, No. 1.
- Lorenz, R. F., Kato, B., and Chen, W. F. (Eds.) (1993), *Semi-Rigid Connections in Steel Frames*, Council for Tall Buildings and Urban Habitat (CTBUH), Lehigh University, Bethlehem, PA.
- Lyse, I., and Schreiner (1935), "An Investigation of Welded Seat Angle Connections," *Welding Journal*, February, p. 1.
- Lyse, I., and Gibson, G. J. (1937), "Effect of Welded Top Angles on Beam-Column Connections," *Welding Journal*, October.
- Marino, F. J. (1966), "Ponding of Two-Way Roof Systems," *Engineering Journal*, AISC, Vol. 3, No. 3, 3rd Quarter, pp. 93-100.
- Morrell, M. L., and Lee, G. C. (1974), *Allowable Stress for Web-Tapered Members*, WRC Bulletin 192, Welding Research Council, New York, NY, February.
- Munse, W. H., and Chesson, Jr., E., (1963), "Riveted and Bolted Joints: Net Section Design," *Journal of the Structural Division*, ASCE, Vol. 89, No. ST1, February, pp. 49-106.
- Murray, T. M., Allen, D. E., and Ungar, E. E. (1997), *Floor Vibrations Due to Human Activity*, Steel Design Guide Series No. 11, AISC, Chicago, IL.
- Murray, T. M., Kline, D. P., and Rojani, K. B. (1992), "Use of Snug-Tightened Bolts in End-Plate Connections," in *Connections in Steel Structures II*, R. Bjorhovde, A. Colson, G. Haaijer, and J. W. B. Stark, (eds.), AISC, Chicago, IL.
- NEHRP (1997), *NEHRP Recommended Provisions for the Development of Seismic Regulations for New Buildings*, Federal Emergency Management Agency Report, FEMA 302, Washington, D. C.
- Nethercot, D. A. (1985), *Steel Beam to Column Connections—A Review of Test Data and Their Applicability to the Evaluation of the Joint Behaviour of the Performance of Steel Frames*, CIRIA, London, England.

- Ollgaard, J. G., Slutter, R. G., and Fisher, J. W. (1971), "Shear Strength of Stud Shear Connections in Lightweight and Normal Weight Concrete," *Engineering Journal*, AISC, Vol. 8, No. 2, 2nd Quarter, pp. 55-64.
- Popov, E. P. (1980), "An Update on Eccentric Seismic Bracing," *Engineering Journal*, AISC, Vol. 17, No. 3, 3rd Quarter, pp. 70-71.
- Popov, E. P., and Stephen, R. M. (1977), "Capacity of Columns with Splice Imperfections," *Engineering Journal*, AISC, Vol. 14, No. 1, 1st Quarter, pp. 16-23.
- Preece, F. R. (1968), *AWS-AISC Fillet Weld Study—Longitudinal and Transverse Shear Tests*, Testing Engineers, Inc., Los Angeles, CA, May.
- Ravindra, M. K., and Galambos, T. V. (1978), "Load and Resistance Factor Design for Steel," *Journal of the Structural Division*, ASCE, Vol. 104, No. ST9, September, pp. 1337-1353.
- Research Council on Structural Connections (RCSC) (1994), *Load and Resistance Factor Design Specification for Structural Joints Using ASTM A325 or A490 Bolts*, AISC, Chicago, IL.
- Ricles, J. M., and Yura, J. A. (1983), "Strength of Double-Row Bolted Web Connections," *Journal of the Structural Division*, ASCE, Vol. 109, No. ST1, January, pp. 126-142.
- Roberts, T. M. (1981), "Slender Plate Girders Subjected to Edge Loading," *Proceedings, Institution of Civil Engineers*, Part 2, 71, September, London, England.
- Salvadori, M. (1956), "Lateral Buckling of Eccentrically Loaded I-Columns," *1956 ASCE Transactions*, Vol. 122-1.
- Seaburg, P. A., and Carter, C. J. (1997), *Torsional Analysis of Structural Steel Members*, Steel Design Guide Series No. 9, AISC, Chicago, IL.
- Sherman, D. R. (1976), *Tentative Criteria for Structural Applications of Steel Tubing and Pipe*, American Iron and Steel Institute, Washington, D.C., August.
- Sherman, D. R., and Tanavde, A. S. (1984), *Comparative Study of Flexural Capacity of Pipes*, Civil Engineering Department Report, University of Wisconsin-Milwaukee, WI, March.
- Slutter, R. G., and Driscoll, G. C. (1965), "Flexural Strength of Steel-Concrete Composite Beams," *Journal of the Structural Division*, ASCE, Vol. 91, No. ST2, April.
- Springfield, J. (1975), "Design of Column Subject to Biaxial Bending," *Engineering Journal*, AISC, Vol. 12, No. 3, 3rd Quarter, pp. 73-81.
- Stang, A. H., and Jaffe, B. S. (1948), *Perforated Cover Plates for Steel Columns*, Research Paper RP1861, National Bureau of Standards, Washington, D.C.
- Steel Structures Painting Council (SSPC) (1989), *Steel Structures Painting Manual, Vol. 2, Systems and Specifications*, SSPC, Pittsburgh, PA.
- Structural Stability Research Council Task Group 20 (1979), "A Specification for the Design of Steel-Concrete Composite Columns," *Engineering Journal*, AISC, Vol. 16, No. 4, 4th Quarter, pp. 101-115.



- Summers, P. A., and Yura, J. A. (1982), *The Behavior of Beams Subjected to Concentrated Loads*, Phil M. Ferguson Structural Engineering Laboratory Report No. 82-5, University of Texas, Austin, TX, August.
- Taylor, A. C., and Ojalvo, M. (1966), "Torsional Restraint of Lateral Buckling," *Journal of the Structural Division*, ASCE, Vol. 92, No. ST2, pp. 115-129.
- Tebedge, N., and Chen, W. F. (1974), "Design Criteria for H-Columns Under Biaxial Loading," *Journal of the Structural Division*, ASCE, Vol. 100, ST3, pp. 579-598.
- Tide, R. H. R. (1985), "Reasonable Column Design Equations," *Proceedings 1985 Annual Technical Session*, Structural Stability Research Council, April, Cleveland, OH, Lehigh University, Bethlehem, PA.
- Timoshenko, S. P., and Gere, J. M. (1961), *Theory of Elastic Stability*, McGraw-Hill Book Company, New York, NY.
- Viest, I. M., Colaco, J. P., Furlong, R. W., Griffis, L. G., Leon, R. T., and Wyllie, Jr., L. A. (1997), *Composite Construction Design for Buildings*, ASCE and McGraw-Hill Book Company, New York, NY.
- Viest, I. M., Fountain, R. S., and Singleton, R. C. (1958), *Composite Construction in Steel and Concrete for Bridges and Buildings*, McGraw-Hill Book Company, New York, NY.
- Wilson, W. M. (1934), *The Bearing Value of Rollers*, Bulletin No. 263, University of Illinois Engineering Experiment Station, Urbana, IL.
- Winter, G. (1958), "Lateral Bracing of Columns and Beams," *Journal of the Structural Division*, ASCE, Vol. 84, No. ST2, March, pp. 1561-1 – 1561-22.
- Winter, G. (1960), "Lateral Bracing of Columns and Beams," *Transactions*, ASCE, Vol. 125, Part 1, pp. 809-825.
- Winter, G. (1970), *Commentary on the 1968 Edition of Light Gage Cold-Formed Steel Design Manual*, American Iron and Steel Institute, Washington, D.C.
- Yura, J. A. (1971), "The Effective Length of Columns in Unbraced Frames," *Engineering Journal*, AISC, Vol. 8, No. 2, April, pp. 37-42.
- Yura, J. A., Galambos, T. V., and Ravindra, K. (1978), "The Bending Resistance of Steel Beams," *Journal of the Structural Division*, ASCE, Vol. 104, No. ST9, September, pp. 1355-1370.
- Yura, J. A. (1988), *Elements for Teaching Load & Resistance Factor Design*, AISC, Chicago, IL, April.
- Yura, J. A. (1993), "Fundamentals of Beam Bracing," *Proc., SSRC Conf., "Is Your Structure Suitably Braced?"*, Milwaukee, WI, April.
- Yura, J. A. (1995), "Bracing for Stability-State-of-the-Art," *Proceedings, Structures Congress XIII*, ASCE, Boston, MA, April, pp. 88-103.
- Zandonini, R. (1985), "Stability of Compact Built-Up Struts: Experimental Investigation and Numerical Simulation," (in Italian) *Costruzioni Metalliche*, No. 4.

Zhou, S. P., and Chen, W. F. (1985), "Design Criteria for Box Columns Under Biaxial Loading," *Journal of Structural Engineering*, ASCE, Vol. 111, No. ST12, December, pp. 2643-2658.

# Supplementary Bibliography

- American Society of Civil Engineers (ASCE) (1971), "Plastic Design in Steel," *ASCE Manual of Engineering Practice*, No. 41, 2nd Edition, New York, NY.
- American Welding Bureau (1931), *Report of Structural Welding Committee*.
- Basler, K., and Thurlimann, B. (1963), "Strength of Plate Girders in Bending," *Journal of the Structural Division*, ASCE, Vol. 89, No. ST4, August.
- Barakat, M., and Chen, W. F. (1991), "Design Analysis of Semi-Rigid Frames: Evaluation and Implementation," *Engineering Journal*, AISC, Vol. 28, No. 2, 2<sup>nd</sup> Quarter, pp. 55-64.
- Beedle, L. S., and Tall, L. (1960), "Basic Column Strength," *Journal of the Structural Division*, ASCE, Vol. 86, No. ST7, July, pp. 139-173.
- Bjorhovde, R., Galambos, T. V., and Ravindra, M. K. (1978), "LRFD Criteria for Steel Beam-Columns," *Journal of the Structural Division*, ASCE, Vol. 104, No. ST9, September, pp. 1371-1387.
- Chen, W. F., and Atsuta, T. (1976), *Theory of Beam Columns, Volume I: In-Plane Behavior and Design*, McGraw-Hill, New York, NY.
- Cheong-Siat Moy, F., Ozer, E., and Lu, L. W. (1977), "Strength of Steel Frames Under Gravity Loads," *Journal of the Structural Division*, ASCE, Vol. 103, No. ST6, June, pp. 1223-1235.
- Daniels, J. H., and Lu, L. W. (1972), "Plastic Subassemblage Analysis for Unbraced Frames," *Journal of the Structural Division*, ASCE, Vol. 98, No. ST8, August, pp. 1769-1788.
- Galambos, T. V. (1980), *Reliability of Axially Loaded Columns*, Washington University, Department of Civil Engineering, St. Louis, MO, December.
- Galambos, T. V., and Ravindra, M. K. (1973), *Tentative Load and Resistance Factor Design Criteria for Steel Buildings*, Research Report No. 18, Washington University, Dept. of Civil Engineering, St. Louis, MO, September.
- Galambos, T. V., and Ravindra, M. K. (1976), *Load and Resistance Factor Design Criteria for Steel Beams*, Research Report No. 27, Washington University, Dept. of Civil Engineering, St. Louis, MO, February.
- Hall, D. H. (1981), "Proposed Steel Column Strength Criteria," *Journal of the Structural Division*, ASCE, Vol. 107, No. ST4, April, pp. 649-670.
- Keating, P. B., and Fisher, J. W. (1985), *Review of Fatigue Tests and Design Criteria on Welded Details*, NCHRP Project 12-15(50), October 1985, Washington, D.C.
- Kotecki, D. S., and Moll, R. A. (1970), "A Toughness Study of Steel Weld Metal from Self-Shielded, Flux-Cored Electrodes, Part 1," *Welding Journal*, AWS, Vol. 49, April.

- Kotecki, D. S., and Moll, R. A. (1972), "A Toughness Study of Steel Weld Metal from Self-Shielded, Flux-Cored Electrodes, Part 2," *Welding Journal*, AWS, Vol. 51, March, p. 138.
- LeMessurier, W. J., McNamara, R. J., and Scrivener, J. C. (1974), "Approximate Analytical Model for Multi-Story Frames," *Engineering Journal*, AISC, Vol. 11, No. 4, 4th Quarter, pp. 92-98.
- Liapunov, S. (1974), "Ultimate Load Studies of Plane Multi-Story Steel Rigid Frames," *Journal of the Structural Division*, ASCE, Vol. 100, No. ST8, Proc. Paper 10750, August.
- Lim, L. C., and Lu, L. W. (1970), *The Strength and Behavior of Laterally Unsupported Columns*, Fritz Engineering Laboratory Report No. 329.5, Lehigh University, Bethlehem, PA, June.
- Lu, L. W. (1967), "Design of Braced Multi-Story Frames by the Plastic Method," *Engineering Journal*, AISC, Vol. 4, No. 1, 1st Quarter, pp. 1-9.
- Lu, L. W., Ozer, E., Daniels, J. H., Okten, O. S., and Morino, S. (1977), "Strength and Drift Characteristics of Steel Frames," *Journal of the Structural Division*, ASCE, Vol. 103, No. ST11, November, pp. 2225-2241.
- Rao, N. R. N., Lohrmann, M., and Tall, L. (1966), "Effect of Strain Rate on the Yield Stress of Structural Steels," *Journal of Materials*, Vol. 1, No. 1, ASTM, March.
- Ross, D. A., and Chen, W. F. (1976), "Design Criteria for Steel I-Columns Under Axial Load and Biaxial Bending," *Canadian Journal of Civil Engineering*, Vol. 3, No. 3.
- Springfield, J., and Adams, P. F. (1972), "Aspects of Column Design in Tall Steel Buildings," *Journal of the Structural Division*, ASCE, Vol. 9, No. ST5, May, pp. 1069-1083.
- Terashima, H., and Hart, P. H. M. (1984), "Effect of Aluminum on Carbon, Manganese, Niobium Steel Submerged Arc Weld Metal Properties," *Welding Journal*, Vol. 63, June, p. 173.
- Wood, B. R., Beaulieu, D., and Adams, P. F. (1976), "Column Design by P-Delta Method," *Journal of the Structural Division*, ASCE, Vol. 102, No. ST2, February, pp. 411-427.



## Metric Conversion Factors for Common Steel Design Units Used in the LRFD Specification

Unit	Multiply	by	to obtain
length	inch (in.)	25.4	millimeters (mm)
length	foot (ft)	0.3048	meters (m)
mass	pound-mass (lbm)	0.4536	kilogram (kg)
stress	ksi	6.895	megapascals (MPa), N/mm <sup>2</sup>
moment	kip-in	113,000	N-mm
energy	ft-lbf	1.356	joule (J)
force	kip (1,000 lbf)	4,448	newton (N)
force	psf	47.88	pascal (Pa), N/m <sup>2</sup>
force	plf	14.59	N/m
temperature	To convert °F to °C: $t_c^\circ = (t_f^\circ - 32)/1.8$		
force in lbf or N = mass × <i>g</i> where <i>g</i> , acceleration due to gravity = 32.2 ft/sec <sup>2</sup> = 9.81 m/sec <sup>2</sup>			

LRFD Specification for Structural Steel Buildings, December 27, 1999



**AMERICAN INSTITUTE OF STEEL CONSTRUCTION, INC.**  
One East Wacker Drive, Suite 3100, Chicago, Illinois 60601-2001

Pub. No. S350L

